

## Declarations & Terms

- Product Updates:** The listed products might be modified or discontinued without advising in advance.
- Quotation:** Quotations are on Ex-Factory based (Shenzhen in China) in major currencies of USD, Euro and RMB. Unimed may adjust the prices yearly so the corresponding price codes will be updated. The proper discount might be available depending on the purchasing volume and items of the individual order.
- Payment:** Bank Transfer and Letter of Credit are recommended. PayPal, West Union and Credit card are also acceptable. The banking fees to be paid by customers will be included.
- Lead time:** Approximately 2 weeks upon orders confirmation by Unimed. The exact delivery date should be finally confirmed by the sales representatives depending on the quantities and business seasons.
- Return & Exchange:** Returning or exchanging is possible within 15 days after the goods are received, on the condition that quality problems are found and then confirmed by Unimed. Problematic products could be repaired or exchanged when they are returned to Unimed factory, provided that failures are found within the warranty period. If no faults are found by Unimed or items are out of warranty, the customers should pay for the shipping cost.
- Legal Affairs:** The original brands or trademarks indicated in the catalogues are for the purpose of referring to the compatibility with Unimed products. They are proprietarily owned by the respective manufacturers. Customers of Unimed are advised to be aware of the patent issue which Unimed products might be involved in the marketed areas, and are responsible for the relevant legal affairs.



Connecting the signals of life

# Product Catalogue 2023/2024

## Patient Monitoring & Diagnostic Cables and Accessories

Version D1.3 Updated 2023-10



Edition of Oct 2023

### Unimed Medical Supplies Inc.

Manufacturing Base: Bld#8, Nangang 3rd Industrial Park,  
Tangtou, Shiyuan, Shenzhen 518108, China

T: (86-755) 26695165  
Website: [www.unimed.cn](http://www.unimed.cn)  
E-mail: [sales@unimed.cn](mailto:sales@unimed.cn)

### Copyright Statement

Copyright Statement: The copyright of this work belongs to Unimed Medical Supplies Inc. and has been registered for copyright protection. Without prior written consent from Unimed, no entity or individual is allowed to copy, modify, adapt, translate, transmit, or plagiarize all or part of this work in any way or do any act that may infringe upon the copyright of the Unimed. All rights reserved.







# Directory

ECG/EKG Cable & Accessories	003
SpO <sub>2</sub> Sensor & Interface Cable	057
NIBP Cuff & Accessories	193
IBP Interface Cable & Transducer	229
TEMP Probe & Interface Cable	241
Original Brands Medical Devices	258
Fetal Transducer & Accessories	259
ETCO <sub>2</sub> Sensor	255
Multi-Parameter Cable	257
Veterinary Vital Sign Monitoring Cables & Accessories	259
PiCCO Cable	275
Respiratory Consumables	277

\*Please find the product information with the corresponding color code & page code.

\*All Unimed new products developed are marked with "☆"

## ABOUT UNIMED

Unimed Medical Supplies Inc. is a leading medical supplies manufacturer specializing in patient monitoring supplies and accessories. For more than 20 years, Unimed have adhered to the customer-oriented service concept and dedicated ourselves to provide a one-stop shop solution at a full range, quality reliable and multi-compatible products to the customers with various patient monitoring accessories including ECG cables, SpO<sub>2</sub> sensor, Temp. probe, NIBP cuff, fetal probe, etc.. Meanwhile, Unimed possess internationally approved certifications allowing Unimed to enter main markets worldwide to serve customers with professional, fast and reliable services.

### Quality Management System

ISO 13485:2016(E)  
MDSAP

### Business Licence

National High Tech Enterprise  
Medical Device Manufacture License:No.20051173

### Main Exhibitions







# ECG Cables & Accessories

- 1. ECG Monitoring Cables & Lead Wires** ..... 005
  - 1.1 ECG Cables & Lead Wires Cross Reference ..... 008
  - 1.2 Major Types or Brands ECG Lead Wires ..... 025
- 2. Telemetry ECG Cables And Holter ECG Cables** ..... 029
- 3. Disposable ECG Monitoring Lead Wires** ..... 033
  - 3.1 Disposable ECG Lead Wires ..... 034
  - 3.2 Disposable One Piece ECG Lead Wires ..... 036
- 4. ECG Radiolucent Lead Wires** ..... 037
  - 4.1 Disposable ECG Radiolucent Lead Wires ..... 038
  - 4.2 Reusable ECG Radiolucent Lead Wires ..... 039
- 5. ECG Lead Adapter and Interface Cable** ..... 040
  - 5.1 ECG Lead Adapter ..... 041
  - 5.1 ECG Lead Interface Cable ..... 043
- 6. Diagnosis EKG Cables & Accessories** ..... 044
  - 6.1 One Piece EKG Fixed Cables ..... 047
  - 6.2 EKG Trunk Cables ..... 049
  - 6.3 EKG Lead Wires ..... 052
  - 6.4 EKG Accessories ..... 054

**Certification**



**Compliance with**

- ISO 15223-1:2021
- ISO 10993-1:2018
- ISO 10993-5:2009
- ISO 10993-10:2021
- ISO 14971:2019
- IEC 60601-1:2005
- IEC 60601-1-2:2014
- IEC 60601-1-6:2010
- IEC 62366-1:2015
- AAMI/ANSI EC53:2013
- ISO 13485:2016



# 1 ECG Monitoring Cables & Lead Wires

## Specification

Cable material	TPU jacket, light gray
Connector & yoke	Nylon plug & Golden plated pins
Main cable length	2.5m
Lead wires length	0.9m

## Compatibility

Major brands ECG or multi-parameter monitoring system

☆ The upgraded type of direct-connected ECG cable is available for choice(see the photo showed as above), the model no.named as original model plus" Z". Eg. the original model is 2609S-I, the upgraded model NO. is 2609S-I-Z

Shielded Cable & Lead Wires	Photo	REF#	REF # Rule Description
One Piece Fixed Cable (Shielded)		2586P	2: Shielded(1=unshielded) 5: 5-lead(3= 3 lead) 86: Factory/model code N: with neonate clip end(default is adult, see the page below for the figure) P: Grabber end(S=snap end) I: IEC code(default is AHA code)
Trunk Cable (Shielded)		MQ-2586	MQ: Cable yoke type 2: Shielded(1=unshielded) 5: 5=lead(3= 3 lead) 86: Factory/model code I: IEC code(default is AHA code)
Lead Wires (Shielded)		MQ5-90P	MQ: Lead wires type 5: 5-lead(3= 3-lead, 6=6lead.....) 90: 90cm(wires length) S: Snap end(P=grabber end) I: IEC code(default is AHA code)
New Type Piece Fixed Cable (Shielded)		2585S-I-Z	2: Shielded (1=unshielded) 5: 5-lead (3=3-lead) 85: Factory/Model code S: Snap end (P=grabber end) I: IEC code (Default is AHA) Z: molding yoke type

Unshielded Cable & Lead Wires	Photo	REF#	REF # Rule Description
Din trunk cable (1.5mm, unshielded ) Used with Din lead wires especially for neonate ECG monitoring		D-1540-I	D: Din style cable 1: Unshielded 5: 5-lead(3=3-lead) 40: Factory/model code I: IEC code (default is AHA code)
Din lead wires (1.5mm, unshielded ) Used with Din trunk cable only		D5-90S-I	D: Din lead wires 5: 5-lead (3=3-lead) 90: 90cm(wires length) S: Snap end(P=grabber end) I: IEC code (default is AHA code)
Neonate lead wires (1.5mm, unshielded )		D3-90NP-I	D: Din lead wires 3: 3-lead (5=5-lead) 90: 90cm(wires length) NP: Mini grabber end I: IEC code (default is AHA code)



ECG Color Code on Electrodes (Regular Grabber/Mini Grabber/Regular Snap)

Code	AHA(A)	Alternate AHA(H)	Standard IEC(I)	Alternate IEC(IH)	AHA(A)	Standard IEC(I)
Regular Grabber						
Mini Grabber						
Snap						











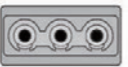
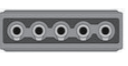

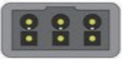
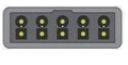

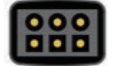
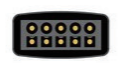

### Search By OEM Manufacturers —ECG Cables & Lead Wires



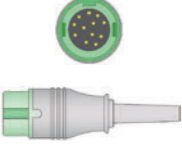

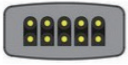







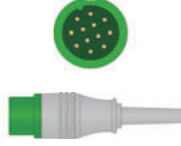

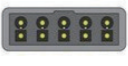

AAMI	008	DRE	012	Mindray > Datascope	019
Abbott	008	ECAFIX	013	Mortara > Burdick	019
Advanced Instrumentations	008	Edan	013	Mortara > Burdick	019
Analogic	009	Emtel	013	Newtech	019
Arrow	009	Fukuda Denshi	013	Nihon Kohden	019
Artema/S&W	009	GE Healthcare	014	Novamatrix	020
ATL	009	GE Healthcare > Corometrics	014	Omron > Colin	020
Bexen Cardio	009	GE Healthcare > Critikon > Dinamap	014	PaceTech	021
Biocare	009	GE Healthcare > Datex Ohmeda	015	Penlon InterMed	021
Biolight	010	GE Healthcare > Marquette	015	Petas	021
Bionet	010	GE Healthcare > Hellige	015	Philips	021
Biosys	010	Innocare	015	Primedic	021
Bruker	010	Infinium	015	Schiller	021
Cardio Aid	010	Invivo	016	Sigowill	022
Carewell	011	Ivy Biomedical	016	Sinohero	022
CAS Medical	011	Kontron	016	Skandray > Larsen & Toubro	022
Comen	011	Lohmeier	016	Smiths Medical > BCI	022
Contec	011	Med Dyne	016	Spacelabs	023
Criticare	011	Mediana	016	Saadat/Siare/Heyer Medical	023
Creative	011	Medica D	017	Sonoscape	023
Dixtal	012	Medtronic > Physio Control	017	SJM	023
Draeger/Dräger	012	MEK	017	Welch Allyn	024
Draeger > Air Shields	012	Mennen	017	Zoll	024
Draeger > Siemens	012	Midmark > Cardell	018		

### 1.1 ECG Cables & Lead Wires Cross Reference

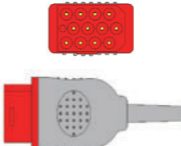
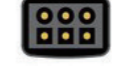
OEM & Models	Monitor Plug	Lead No.	Trunk Cable	Trunk Cable	Lead Wire	Lead Wire	Direct-Conn. Snap	Direct-Conn. Grabber	Din Trunk Cable		
<b>AAMI</b>											
Din style yoke (No resistance)		3	D-1340		D3-90S	D3-90P	2340S	2340P	/		
		Price	C1.3		B4	B4	C3.8	C3.8	/		
		5	D-1540		D5-90S	D5-90P	2540S	2540P	/		
		Price	C2		B6.6	B6.6	C5	C5	/		
		Din style yoke (With 1KΩ resistance)		3	D-1343		D3-90S	D3-90P	2343S	2343P	/
				Price	C1.3		B4	B4	C4	C4	/
5	D-1543				D5-90S	D5-90P	2543S	2543P	/		
Price	C2				B6.6	B6.6	C6	C6	/		
Philips style yoke				3	D-1340R		D3-90S	D3-90P	2340RS	2340RP	/
				Price	C3		B4	B4	C4	C4	/
		5	D-1540R		D5-90S	D5-90P	2540RS	2540RP	/		
		Price	C4		B6.6	B6.6	C7	C7	/		
		Abbott		3	D-1343R		D3-90S	D3-90P	2343RS	2343RP	/
				Price	C3		B4	B4	C5	C5	/
5	D-1543R				D5-90S	D5-90P	2543RS	2543RP	/		
Price	C4				B6.6	B6.6	C7	C7	/		
Advanced Instrumentations				3	AA-2340		AA3-90S	AA3-90P	2340S	2340P	D-1340
				Price	C1.4		B7	B7	C3.8	C3.8	C1.3
		5	AA-2540		AA5-90S	AA5-90P	2540S	2540P	D-1540		
		Price	C3.8		B2	B2	C5	C5	C2		
		Advanced Instrumentations Next Page		3	AA-2340		AA3-90S	AA3-90P	2340S	2340P	D-1340
				Price	C1.4		B7	B7	C3.8	C3.8	C1.3
5	AA-2540				AA5-90S	AA5-90P	2540S	2540P	D-1540		
Price	C3.8				B2	B2	C5	C5	C2		

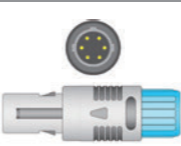
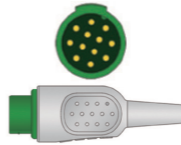

OEM & Models	Monitor Plug	Lead No.	Trunk Cable	Trunk Cable	Lead Wire	Lead Wire	Direct-Conn. Snap	Direct-Conn. Grabber	Din Trunk Cable
<b>Advanced Instrumentations</b>									
PM1000F+		3	HP-2367 HP-2367-I		HP3-90S HP3-90S-I	HP3-90P HP3-90P-I	2367S 2367S-I	2367P 2367P-I	D-1367 D-1367-I
		Price	C4		C1.4	C1.4	C6.7	C6.7	C2
		5	HP-2567 HP-2567-I		HPA5-90S HPA5-90S-I	HPA5-90P HPA5-90P-I	2567S 2567S-I	2567P 2567P-I	D-1567 D-1567-I
		Price	C6		C3.8	C3.8	C8.3	C8.3	C4
<b>Analogic</b>									
Lifeguard II		3	AA-2340 AA-2340-I		AA3-90S AA3-90S-I	AA3-90P AA3-90P-I	2340S 2340S-I	2340P 2340P-I	D-1340 D-1340-I
		Price	C1.4		B7	B7	C3.8	C3.8	C1.3
		5	AA-2540 AA-2540-I		AA5-90S AA5-90S-I	AA5-90P AA5-90P-I	2540S 2540S-I	2540P 2540P-I	D-1540 D-1540-I
		Price	C3.8		C2	C2	C5	C5	C2
<b>Arrow</b>									
AutoCAT2		3	SM-2398 SM-2398-I		SM3-90S SM3-90S-I	SM3-90P SM3-90P-I	2398S 2398S-I	2398P 2398P-I	D-1398 D-1398-I
		Price	C2		B7.9	B7.9	C4	C4	C3.8
		5	SM-2598 SM-2598-I		SM5-90S SM5-90S-I	SM5-90P SM5-90P-I	2598S 2598S-I	2598P 2598P-I	D-1598 D-1598-I
		Price	C5		C3.8	C3.8	C7	C7	C5
<b>Artema/S&amp;W</b>									
8000, Diascope 1, Diascope 2, Diascope NT, Diascope 2010, AtheN/A		3	DX-2397 DX-2397-I		DX3-90S DX3-90S-I	DX3-90P DX3-90P-I	2397S 2397S-I	2397P 2397P-I	D-1397 D-1397-I
		Price	C2		B7	B7	C5	C5	C2
		5	DX-2597 DX-2597-I		DX5-90S DX5-90S-I	DX5-90P DX5-90P-I	2597S 2597S-I	2597P 2597P-I	D-1597 D-1597-I
		Price	C4		C2	C2	C7	C7	C4
<b>ATL</b>									
800, 800Plus, Apogee, CX ATL Ultrasound, CX200, CX400, HDI 9/200, Interspec Cardiology XL, Mark IV, Mark VII, Ultramark 4/5/7/9, 800 Plus, HDI 9/2000		3	AA-2340 AA-2340-I		AA3-90S AA3-90S-I	AA3-90P AA3-90P-I	2340S 2340S-I	2340P 2340P-I	D-1340 D-1340-I
		Price	C1.4		B7	B7	C3.8	C3.8	C1.3
		5	AA-2540 AA-2540-I		AA5-90S AA5-90S-I	AA5-90P AA5-90P-I	2540S 2540S-I	2540P 2540P-I	D-1540 D-1540-I
		Price	C3.8		C2	C2	C5	C5	C2
<b>Bexen Cardio</b>									
Reanibex 300, Reanibex 500, Reanibex 700, Reanibex 800		5	N/A	N/A	N/A	N/A	2518S	2518P	N/A
		Price	N/A		N/A	N/A	2518S-I	2518P-I	N/A
			N/A		N/A	N/A	C6.7	C6.7	N/A
<b>Biocare</b>									
iM12		3	MR-2312 MR-2312-I		MRB3-90S MRB3-90S-I	MRB3-90P MRB3-90P-I	2312S 2312S-I	2312P 2312P-I	D-1312 D-1312-I
		Price	C3.8		B7.9	B7.9	C4	C4	C3
		5	MR-2512 MR-2512-I		MR5-90S MR5-90S-I	MR5-90P MR5-90P-I	2512S 2512S-I	2512P 2512P-I	D-1512 D-1512-I
		Price	C5		C3	C3	C6	C6	C4
iM7/iM8, PM900/PM900S, BM9000/BM9000S		3	AA-2340 AA-2340-I		AA3-90S AA3-90S-I	AA3-90P AA3-90P-I	2340S 2340S-I	2340P 2340P-I	D-1340 D-1340-I
		Price	C1.4		B7	B7	C3.8	C3.8	C1.3
		5	AA-2540 AA-2540-I		AA5-90S AA5-90S-I	AA5-90P AA5-90P-I	2540S 2540S-I	2540P 2540P-I	D-1540 D-1540-I
		Price	C3.8		C2	C2	C5	C5	C2

OEM & Models	Monitor Plug	Lead No.	Trunk Cable	Lead Yoke Conn.	Lead Wire Snap	Lead Wire Grabber	One piece Snap	One piece Grabber	Din Trunk Cable
<b>Biolight</b>									
M7000, M8000, M9000, M9500		3	LL-2357 LL-2357-I		LL3-90S LL3-90S-I	LL3-90P LL3-90P-I	2357S 2357S-I	2357P 2357P-I	D-1357 D-1357-I
		Price	C4		B6.5	B6.5	C6.7	C6.7	C4
		5	LL-2557 LL-2557-I		LL5-90S LL5-90S-I	LL5-90P LL5-90P-I	2557S 2557S-I	2557P 2557P-I	D-1557 D-1557-I
		Price	C6		C1.4	C1.4	C8.3	C8.3	C6
Any View A2E/A3/A5/A6/A8 Any View M10, M12 Any View P1, P12, P15 , P18, P22 Any View S7, S9, S10, S12 BLT Q3, Q4, Q5, Q6.		3	HP-2367 HP-2367-I		HP3-90S HP3-90S-I	HP3-90P HP3-90P-I	2367S 2367S-I	2367P 2367P-I	D-1367 D-1367-I
		Price	C4		C1.4	C1.4	C6.7	C6.7	C4
		5	HP-2567 HP-2567-I		HPA5-90S HPA5-90S-I	HPA5-90P HPA5-90P-I	2567S 2567S-I	2567P 2567P-I	D-1567 D-1567-I
		Price	C6		C3.8	C3.8	C8.3	C8.3	C6
M8000, M9000		3	AA-2340 AA-2340-I		AA3-90S AA3-90S-I	AA3-90P AA3-90P-I	2340S 2340S-I	2340P 2340P-I	D-1340 D-1340-I
		Price	C1.4		B7	B7	C3.8	C3.8	C1.3
		5	AA-2540 AA-2540-I		AA5-90S AA5-90S-I	AA5-90P AA5-90P-I	2540S 2540S-I	2540P 2540P-I	D-1540 D-1540-I
		Price	C3.8		C2	C2	C5	C5	C2
<b>Bionet</b>									
BM3, BM3VET		3	BN-2314 B-CBL-N BN-2314-I		BN3-90S BN3-90S-I	BN3-90P BN3-90P-I	2314S 2314S-I	2314P 2314P-I	D-1314 D-1314-I
		Price	C2		B7	B7	C5	C5	C2
		5	BN-2514 B-CBL-N BN-2514-I		BN5-90S BN5-90S-I	BN5-90P BN5-90P-I	2514S 2514S-I	2514P 2514P-I	D-1514 D-1514-I
		Price	C4		C2	C2	C7	C7	C4
BM5, BM7		3	BN-23115 BN-23115-I		BN3-90S BN3-90S-I	BN3-90P BN3-90P-I	23115S 23115S-I	23115P 23115P-I	D-13115 D-13115-I
		Price	C2		B7	B7	C4	C4	C2
		5	BN-25115 BN-25115-I		BN5-90S BN5-90S-I	BN5-90P BN5-90P-I	25115S 25115S-I	25115P 25115P-I	D-15115 D-15115-I
		Price	C4		C2	C2	C6.7	C6.7	C4
<b>Biosys</b>									
BPM-103		3	N/A	N/A	N/A	N/A	2335S	2335P	D-1335
		Price	N/A		N/A	N/A	2335S-I	2335P-I	D-1335-I
		5	N/A		N/A	N/A	2535S	2535P	D-1535
		Price	N/A		N/A	N/A	2535S-I	2535P-I	D-1535-I
<b>Bruker</b>									
Bruker (Odam) all, as DC-3002, IH, M3		3	N/A	N/A	N/A	N/A	2324S	2324P	D-1324
		Price	N/A		N/A	N/A	2324S-I	2324P-I	D-1324-I
		5	N/A		N/A	N/A	2524S	2524P	D-1524
		Price	N/A		N/A	N/A	2524S-I	2524P-I	D-1524-I
<b>Cardio Aid</b>									
200		3	DX-2397 DX-2397-I		DX3-90S DX3-90S-I	DX3-90P DX3-90P-I	2397S 2397S-I	2397P 2397P-I	D-1397 D-1397-I
		Price	C2		B7	B7	C5	C5	C2
		5	DX-2597 DX-2597-I		DX5-90S DX5-90S-I	DX5-90P DX5-90P-I	2597S 2597S-I	2597P 2597P-I	D-1597 D-1597-I
		Price	C4		C2	C2	C7	C7	C4



OEM & Models	Monitor Plug	Lead No.	Trunk Cable	Trunk Cable	Lead Wire	Lead Wire	Direct-Conn. Snap	Direct-Conn. Grabber	Din Trunk Cable
<b>Carewell</b>									
CPM-8000		3	AA-2340		AA3-90S	AA3-90P	2340S	2340P	D-1340
			AA-2340-I		AA3-90S-I	AA3-90P-I	2340S-I	2340P-I	D-1340-I
		Price	C1.4	B7	B7	C3.8	C3.8	C1.3	
		5	AA-2540	AA5-90S	AA5-90P	2540S	2540P	D-1540	
AA-2540-I	AA5-90S-I		AA5-90P-I	2540S-I	2540P-I	D-1540-I			
			C3.8	C2	C2	C5	C5	C2	
<b>CAS Medical</b>									
511 Apnea Monitor		3	N/A	N/A	N/A	N/A	2339S	2339P	D-1339
			N/A		N/A	N/A	2339S-I	2339P-I	D-1339-I
		Price	N/A	N/A	N/A	C4	C4	C2	
750		3	N/A	N/A	N/A	N/A	2364S	2364P	D-1364
			N/A		N/A	N/A	2364S-I	2364P-I	D-1364-I
		Price	N/A	N/A	N/A	C4	C4	C2	
<b>Comen</b>									
STAR-8000A/B/C/D /E/H, STAR-5000C, C80		3	AA-2340		AA3-90S	AA3-90P	2340S	2340P	D-1340
			AA-2340-I		AA3-90S-I	AA3-90P-I	2340S-I	2340P-I	D-1340-I
		Price	C1.4	B7	B7	C3.8	C3.8	C1.3	
		5	AA-2540	AA5-90S	AA5-90P	2540S	2540P	D-1540	
AA-2540-I	AA5-90S-I		AA5-90P-I	2540S-I	2540P-I	D-1540-I			
			C3.8	C2	C2	C5	C5	C2	
C20, C21, C30, C50, C70, C90, C100, C100A, NC3, NC5, NC8, NC10, NC12, NC19		3	AA-2347		AA3-90S	AA3-90P	2347S	2347P	D-1347
			AA-2347-I		AA3-90S-I	AA3-90P-I	2347S-I	2347P-I	D-1347-I
		Price	C3	B7	B7	C4	C4	C3	
		5	AA-2547	AA5-90S	AA5-90P	2547S	2547P	D-1547	
AA-2547-I	AA5-90S-I		AA5-90P-I	2547S-I	2547P-I	D-1547-I			
			C5	C2	C2	C6	C6	C5	
<b>Contec</b>									
CMS 6800, CMS 8000, CMS 9000		3	AA-2340		AA3-90S	AA3-90P	2340S	2340P	D-1340
			AA-2340-I		AA3-90S-I	AA3-90P-I	2340S-I	2340P-I	D-1340-I
		Price	C1.4	B7	B7	C3.8	C3.8	C1.3	
		5	AA-2540	AA5-90S	AA5-90P	2540S	2540P	D-1540	
AA-2540-I	AA5-90S-I		AA5-90P-I	2540S-I	2540P-I	D-1540-I			
			C3.8	C2	C2	C5	C5	C2	
<b>Corpuls</b>									
Corpuls3		4	N/A		N/A	N/A	24144S	24144P	N/A
			N/A		N/A	24144S-I	24144P-I	N/A	
		Price	N/A	N/A	N/A	D3.2	D3.2	N/A	
		6	N/A	N/A	N/A	26144S	26144P	N/A	
N/A	N/A		N/A	26144S-I	26144P-I	N/A			
		Price	N/A	N/A	N/A	DD1.7	DD1.7	N/A	
<b>Criticare</b>									
504US, 602A-A, 506, 507, 507E, 508, 1100, 1508, 8100, Poet 2, Scholar EL, Scholar II 507EP, Scholar III 507EL, 8100E nGenuity, 8100H nCompass, 8500 Poet IQ2		3	AA-2340		AA3-90S	AA3-90P	2340S	2340P	D-1340
			AA-2340-I		AA3-90S-I	AA3-90P-I	2340S-I	2340P-I	D-1340-I
		Price	C1.4	B7	B7	C3.8	C3.8	C1.3	
		5	AA-2540	AA5-90S	AA5-90P	2540S	2540P	D-1540	
AA-2540-I	AA5-90S-I		AA5-90P-I	2540S-I	2540P-I	D-1540-I			
			C3.8	C2	C2	C5	C5	C2	
<b>Creative</b>									
PC9000S, PC9000, UP6000		3	N/A	N/A	N/A	N/A	2330S	2330P	D-1330
			N/A		N/A	2330S-I	2330P-I	D-1330-I	
		Price	N/A	N/A	N/A	C5	C5	C2	
		5	N/A	N/A	N/A	2530S	2530P	D-1530	
N/A	N/A		N/A	2530S-I	2530P-I	D-1530-I			
		Price	N/A	N/A	N/A	C7	C7	C3.8	

OEM & Models	Monitor Plug	Lead No.	Trunk Cable	Trunk Cable	Lead Wire	Lead Wire	Direct-Conn. Snap	Direct-Conn. Grabber	Din Trunk Cable
<b>Dixtal</b>									
EP12		10	N/A	N/A	N/A	N/A	21070S	21070P	N/A
			N/A		N/A	21070S-I	21070P-I	N/A	
		Price	N/A	N/A	N/A	DD1.3	DD1.3	N/A	
DX 2022, DX 2515		3	AA-2340		AA3-90S	AA3-90P	2340S	2340P	D-1340
			AA-2340-I		AA3-90S-I	AA3-90P-I	2340S-I	2340P-I	D-1340-I
		Price	C1.4	B7	B7	C3.8	C3.8	C1.3	
		5	AA-2540	AA5-90S	AA5-90P	2540S	2540P	D-1540	
AA-2540-I	AA5-90S-I		AA5-90P-I	2540S-I	2540P-I	D-1540-I			
			C3.8	C2	C2	C5	C5	C2	
<b>Draeger/Dräger</b>									
Babyguard 8000, Cato, Cicero, Parameterbox, PB8800, PM8010, PM8014, PM8060, RM1, Series 8000, UMI, UM3, UM3.1		3	N/A	N/A	N/A	N/A	2377S	2377P	D-1377
			N/A		N/A	2377S-I	2377P-I	D-1377-I	
		Price	N/A	N/A	N/A	C4	C4	C2	
Vitalert 2000, Vitalert 3000, Vista 120		3	MR-2340		MRB3-90S	MRB3-90P	2340S	2340P	D-1340
			MR-2340-I		MRB3-90S-I	MRB3-90P-I	2340S-I	2340P-I	D-1340-I
		Price	C3	B7.9	C3	C3.8	C3.8	C1.3	
		5	MR-2540	MR5-90S	MR5-90P	2540S	2540P	D-1540	
MR-2540-I	MR5-90S-I		MR5-90P-I	2540S-I	2540P-I	D-1540-I			
			C4	C3	C4	C5	C5	C2	
<b>Draeger &gt; Air Shields</b>									
HRRM-71-1, HRRM-71-2, II, III, Porta-Fib I, Porta-Fib II, Porta-Fib III, System 5 (New), System 6 (NeoN/Atal), System VI-S		3	AA-2340		AA3-90S	AA3-90P	2340S	2340P	D-1340
			AA-2340-I		AA3-90S-I	AA3-90P-I	2340S-I	2340P-I	D-1340-I
		Price	C1.4	B7	B7	C3.8	C3.8	C1.3	
		5	AA-2540	AA5-90S	AA5-90P	2540S	2540P	D-1540	
AA-2540-I	AA5-90S-I		AA5-90P-I	2540S-I	2540P-I	D-1540-I			
		Price	C3.8	C2	C2	C5	C5	C2	
<b>Draeger &gt; Siemens</b>									
Polymed, Sirecust 1200, Sirecust 1260, Sirecust 1281, Sirecust 1801, Sirecust 341, Sirecust 400, Sirecust 500, Sirecust 600, Sirecust 610, Sirecust 620, Sirecust 630, Sirecust 700, Sirecust 720, Sirecust 732, Sirecust 730, Sirecust 960, Sirecust 961, Sirem		3	SM-2376		SM3-90S	SM3-90P	2376S	2376P	D-1376
			SM-2376-I		SM3-90S-I	SM3-90P-I	2376S-I	2376P-I	D-1376-I
		Price	C2	B7.9	B7.9	C4	C4	C2	
		5	SM-2576	SM5-90S	SM5-90P	2576S	2576P	D-1576	
SM-2576-I	SM5-90S-I		SM5-90P-I	2576S-I	2576P-I	D-1576-I			
		Price	C4	C3.8	C3.8	C6.7	C6.7	C4	
SC 5000, SC 6000, SC 7000, SC 8000, SC 9000		3	SM-2323		SM3-90S	SM3-90P	2323S	2323P	D-1323
			SM-2323-I		SM3-90S-I	SM3-90P-I	2323S-I	2323P-I	D-1323-I
		Price	C2	B7.9	B7.9	C4	C4	C2	
Somatom Sensation		3	N/A	N/A	N/A	N/A	2363S	2363P	N/A
			N/A		N/A	2363S-I	2363P-I	N/A	
		Price	N/A	N/A	N/A	DD1	DD1	N/A	
Acuson C256, Acuson CV70, Acuson Sequoia 512, Acuson X300, Acuson X700, SC 2000, SC 3000, Sirecust 3000DU, Sirecust 610, Sirecust 630, Sirecust DU		3	N/A	N/A	N/A	N/A	2340S	2340P	N/A
			N/A		N/A	2340S-I	2340P-I	N/A	
		Price	N/A	N/A	N/A	C3.8	C3.8	N/A	
		3	N/A	N/A	N/A	23135RS	23135RP	N/A	
N/A	N/A		N/A	23135RS-I	23135RP-I	N/A			
		Price	N/A	N/A	N/A	C6.7	C6.7	N/A	
<b>DRE</b>									
Waveline EZ, Touch,Pro		3	MQ-2580		MQ3-90S	MQ3-90P	2380S	2380P	D-1380
			MQ-2580-I		MQ3-90S-I	MQ3-90P-I	2380S-I	2380P-I	D-1380-I
		Price	C4	B8.1	B8.1	C5	C5	C2	
		5	MQ-2580	MQ5-90S	MQ5-90P	2580S	2580P	D-1580	
MQ-2580-I	MQ5-90S-I		MQ5-90P-I	2580S-I	2580P-I	D-1580-I			
		Price	C4	C3.8	C3.8	C7	C7	C4	











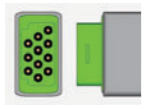



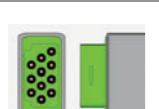

DRE Next Page

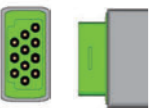

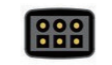











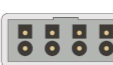

OEM & Models	Monitor Plug	Lead No.	Trunk Cable	Trunk Cable	Lead Wire	Lead Wire	Direct-Conn. Snap	Direct-Conn. Grabber	Din Trunk Cable	
<b>DRE</b>										
ASM 6000, Trax, Vida, Waveline		3	SM-2398		SM3-90S	SM3-90P	2398S	2398P	D-1398	
		Price	SM-2398-I		SM3-90S-I	SM3-90P-I	2398S-I	2398P-I	D-1398-I	
		5	SM-2598		SM5-90S	SM5-90P	2598S	2598P	D-1598	
		Price	SM-2598-I		SM5-90S-I	SM5-90P-I	2598S-I	2598P-I	D-1598-I	
Waveline EZ MAX		3	AA-2340		AA3-90S	AA3-90P	2340S	2340P	D-1340	
		Price	AA-2340-I		AA3-90S-I	AA3-90P-I	2340S-I	2340P-I	D-1340-I	
		5	AA-2540		AA5-90S	AA5-90P	2540S	2540P	D-1540	
		Price	AA-2540-I		AA5-90S-I	AA5-90P-I	2540S-I	2540P-I	D-1540-I	
<b>ECAFIX</b>										
		5	N/A	N/A	N/A	N/A	2552S	2552P	N/A	
		Price	N/A		N/A	N/A	2552S-I	2552P-I	N/A	
		Price	N/A		N/A	N/A	C6.7	C6.7	N/A	
<b>Edan</b>										
iM50, iM60, iM70, iM80, iM8, iM8A, iM9, iM9A, M3, M3A, M3B, M8, M8A, M8B, M9, M9A		3	AA-2340		AA3-90S	AA3-90P	2340S	2340P	D-1340	
		Price	AA-2340-I		AA3-90S-I	AA3-90P-I	2340S-I	2340P-I	D-1340-I	
		5	AA-2540		AA5-90S	AA5-90P	2540S	2540P	D-1540	
		Price	AA-2540-I		AA5-90S-I	AA5-90P-I	2540S-I	2540P-I	D-1540-I	
<b>Emtel</b>										
FX2000		3	N/A	N/A	N/A	N/A	2322RS	2322RP	D-1322	
		Price	N/A		N/A	N/A	2322RS-I	2322RP-I	D-1322-I	
		5	N/A			N/A	N/A	2522RS	2522RP	D-1522
		Price	N/A			N/A	N/A	2522RS-I	2522RP-I	D-1522-I
FX2000, FX3000 FX3000C, FX3000MD E1510		3	N/A	N/A	N/A	N/A	2311RS	2311RP	D-1311R	
		Price	N/A		N/A	N/A	2311RS-I	2311RP-I	D-1311R-I	
		5	N/A			N/A	N/A	2511RS	2511RP	D-1522
		Price	N/A			N/A	N/A	2511RS-I	2511RP-I	D-1522-I
<b>Fukuda Denshi</b>										
DS-7000, DS-7100, DS-7200, DS-7300		3 (defibrillation -proof)	SM-2399 CI-700D-3 (AHA) SM-2399-I CI-700D-3 (IEC)		SM3-90S	SM3-90S	2399S	2399P	D-1399	
		Price	C3.8		SM3-90S-I	SM3-90S-I	2399S-I	2399P-I	D-1399-I	
		3 (electrosurgery -proof)	SMD-2399 CI-700E-3 (AHA) SMD-2399-I CI-700E-3 (IEC)		SM3-90S	SM3-90S	N/A	N/A	N/A	N/A
		Price	C5		SM3-90S-I	SM3-90S-I	N/A	N/A	N/A	
		5 (defibrillation -proof)	SM-2599 CI-700D-5 (AHA) SM-2599-I CI-700D-5 (IEC)		SM5-90S	SM5-90P	2599S	2599P	D-1599	
		Price	C6		SM5-90S-I	SM5-90P-I	2599S-I	2599P-I	D-1599-I	
		5 (electrosurgery -proof)	SMD-2599 CI-700E-5 (AHA) SMD-2599-I CI-700E-5 (IEC)		SM5-90S	SM5-90P	N/A	N/A	N/A	
		Price	C8		SM5-90S-I	SM5-90P-I	N/A	N/A	N/A	
		10 (defibrillation -proof)	MQ-21099 CI-06CRL (AHA) MQ-21099-I CI-06CRL (IEC)		MQ5-90S MV5-90S	MQ5-90P MV5-90P	21099S	21099P	N/A	
		Price	D1		MQ5-90S-I MV5-90S-I	MQ5-90P-I MV5-90P-I	21099S-I	21099P-I	N/A	

Fukuda Denshi Next Page

OEM & Models	Monitor Plug	Lead No.	Trunk Cable	Trunk Cable	Lead Wire	Lead Wire	Direct-Conn. Snap	Direct-Conn. Grabber	Din Trunk Cable	
<b>Fukuda Denshi</b>										
DSL-8001, DS-8005, DS-8007, DS-8100, DS-8200, DS-8400, DS-8500		3	SM-23109 SM-23109-I CI-05CTP-3NU		SM3-90S	SM3-90P	23109S	23109P	D-13109	
		Price	C4		SM3-90S-I	SM3-90P-I	23109S-I	23109P-I	D-13109-I	
		5	SM-25109 SM-25109-I CI-05CTP-5NU		SM5-90S	SM5-90P	25109S	25109P	D-15109	
		Price	C6		SM5-90S-I	SM5-90P-I	25109S-I	25109P-I	D-15109-I	
DS-5100, DS-5100E, DS-5300W, DS-5400, DS-7001		3	N/A	N/A	N/A	N/A	2359S	2359P	D-1359	
		Price	N/A		N/A	N/A	2359S-I	2359P-I	D-1359-I	
		5	SM-2559			SM5-90S	SM5-90P	2559S	2559P	D-1559
		Price	C5			SM5-90S-I	SM5-90P-I	2559S-I	2559P-I	D-1559-I
<b>GE Healthcare</b>										
Procare B20, Procare B40		3	MQ-2586 2017003-001(3.6m) MQ-2586-I 2017003-003(3.6m)		MQ3-90S 412682-001	MQ3-90P 412682-001	2386S 2001292-001	2386P 2021141-001	D-1386 2017004-001(3.6m)	
		Price	C5		MQ3-90S-I 412682-003	MQ3-90P-I 412682-003	2386S-I 2001292-002	2386P-I 2021141-002	D-1386-I 2017004-003(3.6m)	
		5	MQ-2586 2017003-001(3.6m) MQ-2586-I 2017003-003(3.6m)		MQ5-90S 411262-001	MQ5-90P 412681-001	2586S 2017003-001	2586P 2021141-001	D-1586 2017004-001(3.6m)	
		Price	C5		MQ5-90S-I 411262-003	MQ5-90P-I 412681-003	2586S-I 2017003-001	2586P-I 2021141-001	D-1586-I 2017004-003(3.6m)	
Vivid 7, Vivid S6, Vivid i, Vivid q, Vivid e		3-(LA+RA+LL)	MQA-2382 2418831-2		MQA3-90S	MQA3-90P	2382S	2382P 2418831-2	N/A	
		Price	C3.8		MQA3-90S-I	MQA3-90P-I	2382S-I	2382P-I	N/A	
		3-(L+R+F)	MQA-2382-I		B8.1	B8.1	C6	C6	N/A	
		Price	C3.8		MQB3-90S	MQB3-90P	2381S	2381P	N/A	
Logiq 5, Logiq 7, Logiq P6, Logiq P6 Pro, Logiq e9		3-(LL+RA+RL)	MQB-2381 5341186		MQB3-90S	MQB3-90P	2381S	2381P	N/A	
		Price	C3.8		MQB3-90S-I	MQB3-90P-I	2381S-I	2381P-I	N/A	
		3-(L+R+N)	MQB-2381-I		B8.1	B8.1	C6	C6	N/A	
		Price	C3.8		MQ3-90S MV5-90S	MQ3-90P MV5-90P	210110S	210110P	N/A	
CT 4-9		10	MQ-210110 MQ-210110-I		MQ5-90S MV5-90S	MQ5-90P MV5-90P	210110S	210110P	N/A	
		Price	C7		MQ5-90S-I MV5-90S-I	MQ5-90P-I MV5-90P-I	210110S-I	210110P-I	N/A	
		3.8*2			C3.8*2	C3.8*2	D3	D3	N/A	
		Price	C7							
<b>GE Healthcare &gt; Corometrics</b>										
115, 116, 118, 120, 151		3	MQ-2319 15549A0 MQ-2319-I 15549A0		MQ3-90S	MQ3-90P	2319S	2319P	D-1319	
		Price	N/A		MQ3-90S-I	MQ3-90P-I	2319S-I	2319P-I	D-1319-I	
		5	FECG/MECG Y Adapter Cable		B8.1	B8.1	C4	C4	N/A	
		Price	D3.8		2319S	2319P	N/A	N/A	N/A	
115, 116, 118, 120, 129, 130, 151, 250cx, 259cx		3	ADE-001-MF 1442AA0		2319S	2319P	N/A	N/A	N/A	
		Price	D3.8		2319S-I	2319P-I	N/A	N/A	N/A	
		5			C4	C4	N/A	N/A	N/A	
		Price	D3.8							
<b>GE Healthcare &gt; Critikon &gt; Dinamap</b>										
Carescape B450, Carescape B650, Carescape B850		3	MQ-2586		MQ3-90S	MQ3-90P	2386S	2386P	D-1386	
		Price	C5		MQ3-90S-I	MQ3-90P-I	2386S-I	2386P-I	D-1386-I	
		5	MQ-2586		B8.1	B8.1	C4	C4	N/A	
		Price	C5		MQ5-90S	MQ5-90P	2586S	2586P	D-1586	
8100T, 8700 Series, 8700/9700, 9700 Series, MPS Select, Pro 1000		3	AA-2340		AA3-90S	AA3-90P	2340S	2340P	D-1340	
		Price	C1.4		AA3-90S-I	AA3-90P-I	2340S-I	2340P-I	D-1340-I	
		5	AA-2540		B7	B7	C3.8	C3.8	N/A	
		Price	C3.8		AA5-90S	AA5-90P	2540S	2540P	D-1540	

OEM & Models	Monitor Plug	Lead No.	Trunk Cable	Trunk Cable	Lead Wire	Lead Wire	Direct-Conn. Snap	Direct-Conn. Grabber	Din Trunk Cable
<b>GE Healthcare &gt; Datex Ohmeda</b>									
Aestiva/5, E-PRESTN, M-PRESTN, Unity		3	MQ-2586		MQ3-90S	MQ3-90P	2386S	2386P	D-1386
		Price	MQ-2586-I		MQ3-90S-I	MQ3-90P-I	2386S-I	2386P-I	D-1386-I
		5	MQ-2586		MQ5-90S	MQ5-90P	2586S	2586P	D-1586
		Price	MQ-2586-I		MQ5-90S-I	MQ5-90P-I	2586S-I	2586P-I	D-1586-I
*To be updated		3	DX-2392		DX3-90S	DX3-90P	2392S	2392P	D-1392
		Price	DX-2392-I		DX3-90S-I	DX3-90P-I	2392S-I	2392P-I	D-1392-I
		5	DX-2592		DX5-90S	DX5-90P	2592S	2592P	D-1592
		Price	DX-2592-I		DX5-90S-I	DX5-90P-I	2592S-I	2592P-I	D-1592-I
AS/3, AS/3 Compact, Aespire, CS/3, Cardiacap I, Cardiacap II, Cardiacap/5, Light Monitor, M-ESTP, M-ESTPR, M-NESTPR, M-NESTR, S/5, S/5 Compact, Satlite Plus S5		3	DX-2395		DX3-90S	DX3-90P	2395S	2395P	D-1395
		Price	DX-2395-I		DX3-90S-I	DX3-90P-I	2395S-I	2395P-I	D-1395-I
		5	DX-2595		DX5-90S	DX5-90P	2595S	2595P	D-1595
		Price	DX-2595-I		DX5-90S-I	DX5-90P-I	2595S-I	2595P-I	D-1595-I
<b>GE Healthcare &gt; Marquette</b>									
Dash 1000, Dash 2000, Dash 2500, Dash 3000, Dash 4000, Dash 5000, Dash PRO 2000, Dash PRO 3000, Dash PRO 4000, Eagle, Eagle Systems, MAC-Lab, PDM Module, Responder 2000, Responder 3000, Solar 3000, Solar 8000, Solar 9500, Tram 100, Tram 200, Tram 300, Tram 400, Tram 451, Tram 500, Tram 600, Tram 800, Unity Systems		3	MQ-2586		MQ3-90S	MQ3-90P	2386S	2386P	D-1386
		Price	MQ-2586-I		MQ3-90S-I	MQ3-90P-I	2386S-I	2386P-I	D-1386-I
		5	MQ-2586		MQ5-90S	MQ5-90P	2586S	2586P	D-1586
		Price	MQ-2586-I		MQ5-90S-I	MQ5-90P-I	2586S-I	2586P-I	D-1586-I
Solar 8000i with CARESCAPE PDM/B650/B850		6	MQ-2686		MQB6-90S	MQB6-90P	N/A	N/A	N/A
		Price	MQ-2686-I		MQB6-90S-I	MQB6-90P-I	N/A	N/A	N/A
		10	MQ-21086		MQ5-90S	MQ5-90P	21086S	21086P	N/A
		Price	MQ-21086-I		MQ5-90S-I	MQ5-90P-I	21086S-I	21086P-I	N/A
<b>GE Healthcare &gt; Hellige</b>									
CardioServ, Generation, SCP 844, SCP 851, SCP 852, SCS 804, Servomed 4, Vicom SM, SMS, SMC, VICOM-SM		3	DX-2355		DX3-90S	DX3-90P	2355S	2355P	D-1355
		Price	DX-2355-I		DX3-90S-I	DX3-90P-I	2355S-I	2355P-I	D-1355-I
		5	DX-2555		DX5-90S	DX5-90P	2555S	2555P	D-1555
		Price	DX-2555-I		DX5-90S-I	DX5-90P-I	2555S-I	2555P-I	D-1555-I
Tram 7200		5	MQ-2584		MQ5-90S	MQ5-90P	2584S	2584P	N/A
		Price	MQ-2584-I		MQ5-90S-I	MQ5-90P-I	2584S-I	2584P-I	N/A
		5	MQ-2584		MQ5-90S	MQ5-90P	2584S	2584P	N/A
		Price	MQ-2584-I		MQ5-90S-I	MQ5-90P-I	2584S-I	2584P-I	N/A
<b>Innocare</b>									
IM200, InnoCare-VET		5	N/A	N/A	N/A	N/A	2550S	2550P	N/A
		Price	N/A		N/A	N/A	2550S-I	2550P-I	N/A
		5	N/A		N/A	N/A	2550S	2550P	N/A
<b>Infinium</b>									
Mira, Vega		3	SM-2398		SM3-90S	SM3-90P	2398S	2398P	D-1398
		Price	SM-2398-I		SM3-90S-I	SM3-90P-I	2398S-I	2398P-I	D-1398-I
		5	SM-2598		SM5-90S	SM5-90P	2598S	2598P	D-1598
		Price	SM-2598-I		SM5-90S-I	SM5-90P-I	2598S-I	2598P-I	D-1598-I
		5	SM-2598		SM5-90S	SM5-90P	2598S	2598P	D-1598
		Price	SM-2598-I		SM5-90S-I	SM5-90P-I	2598S-I	2598P-I	D-1598-I
<b>Infinium Next Page</b>									











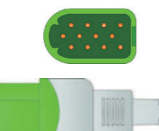



OEM & Models	Monitor Plug	Lead No.	Trunk Cable	Trunk Cable	Lead Wire	Lead Wire	Direct-Conn. Snap	Direct-Conn. Grabber	Din Trunk Cable
<b>Infinium</b>									
Omni III		3	MQ-2580		MQ3-90S	MQ3-90P	2380S	2380P	D-1380
		Price	MQ-2580-I		MQ3-90S-I	MQ3-90P-I	2380S-I	2380P-I	D-1380-I
		5	MQ-2580		MQ5-90S	MQ5-90P	2580S	2580P	D-1580
		Price	MQ-2580-I		MQ5-90S-I	MQ5-90P-I	2580S-I	2580P-I	D-1580-I
Infitron II, Omni, Omni II		3	AA-2340		AA3-90S	AA3-90P	2340S	2340P	D-1340
		Price	AA-2340-I		AA3-90S-I	AA3-90P-I	2340S-I	2340P-I	D-1340-I
		5	AA-2540		AA5-90S	AA5-90P	2540S	2540P	D-1540
		Price	AA-2540-I		AA5-90S-I	AA5-90P-I	2540S-I	2540P-I	D-1540-I
<b>Invivo</b>									
101, 102, 200, 300, 360SL, 450SL, 521A, Escort 100, Escort 101, Escort 102, Escort 200, Escort 300, Millennia 3500, PortaPak 1000, PortaPak 80, PortaPak 90, PortaPak 90/1000, Prism		3	AA-2340		AA3-90S	AA3-90P	2340S	2340P	D-1340
		Price	AA-2340-I		AA3-90S-I	AA3-90P-I	2340S-I	2340P-I	D-1340-I
		5	AA-2540		AA5-90S	AA5-90P	2540S	2540P	D-1540
		Price	AA-2540-I		AA5-90S-I	AA5-90P-I	2540S-I	2540P-I	D-1540-I
<b>Ivy Biomedical</b>									
Model 7600/7800/7810		4	AA-2440		AAC4-90S	AAC4-90P	2440S	2440P	N/A
		Price	AA-2440-I		AAC4-90S-I	AAC4-90P-I	2440S-I	2440P-I	N/A
<b>Kontron</b>									
7000, 7135, 7135B, 7141, 7210, 7250, 7251, K2000, KSLT, Kolormon, Micromon, Minimon, Supermon, Vitalmon		3	SM-2398		SM3-90S	SM3-90P	2398S	2398P	D-1398
		Price	SM-2398-I		SM3-90S-I	SM3-90P-I	2398S-I	2398P-I	D-1398-I
		5	SM-2598		SM5-90S	SM5-90P	2598S	2598P	D-1598
		Price	SM-2598-I		SM5-90S-I	SM5-90P-I	2598S-I	2598P-I	D-1598-I
105, 107, 108, 125, 128, VSM510, Old generation		3	N/A	N/A	N/A	N/A	2393S	2393P	D-1393
		Price	N/A		N/A	N/A	2393S-I	2393P-I	D-1393-I
<b>Lohmeier</b>									
M010, M011/M211 Defi 501		3	N/A	N/A	N/A	N/A	2358S	2358P	N/A
		Price	N/A		N/A	N/A	2358S-I	2358P-I	N/A
<b>Med Dyne</b>									
ALL		3	N/A	N/A	N/A	N/A	2339S	2339P	D-1339
		Price	N/A		N/A	N/A	2339S-I	2339P-I	D-1339-I
<b>Mediana</b>									
101, 101 (before 1989), 3000, 402, 700, 7800, Cardiac Trigger Monitor 3150		3	AA-2340		AA3-90S	AA3-90P	2340S	2340P	D-1340
		Price	AA-2340-I		AA3-90S-I	AA3-90P-I	2340S-I	2340P-I	D-1340-I
		5	AA-2540		AA5-90S	AA5-90P	2540S	2540P	D-1540
		Price	AA-2540-I		AA5-90S-I	AA5-90P-I	2540S-I	2540P-I	D-1540-I
Defibrillator D500		3	N/A	N/A	N/A	N/A	23104S	23104P	N/A
		Price	N/A		N/A	N/A	23104S-I	23104P-I	N/A







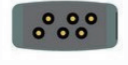

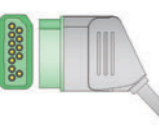
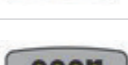



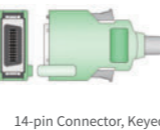

OEM & Models	Monitor Plug	Lead No.	Trunk Cable	Trunk Cable	Lead Wire	Lead Wire	Direct-Conn. Snap	Direct-Conn. Grabber	Din Trunk Cable
<b>Medica D</b>									
Logicare Series 2000		3	MR-2312		MRB3-90S	MRB3-90P	2312S	2312P	D-1312
		Price	C3.8		MRB3-90S-I	MRB3-90P-I	2312S-I	2312P-I	D-1312-I
	5	MR-2512		MR5-90S	MR5-90P	2512S	2512P	D-1512	
		Price	C5		MR5-90S-I	MR5-90P-I	2512S-I	2512P-I	D-1512-I
<b>Medtronic &gt; Physio Control</b>									
1440/R, Lifepak 5, Lifepak 6, Lifepak6S, Lifepak 7, Lifepak 8, Lifepak 9, VSM-1ESF, VSM-2, VSM-2ESF, VSM-3		3	DX-2340R		DX3-90S	DX3-90P	2340RS	2340RP	D-1340R
		Price	C4		DX3-90S-I	DX3-90P-I	2340RS-I	2340RP-I	D-1340R-I
Lifepak 11, Lifepak 12, Lifepak 15, Lifepak 20, Lifepak 20E		3	N/A	N/A	N/A	N/A	2327S	2327P	N/A
		Price	N/A	N/A	N/A	N/A	2327S-I	2327P-I	N/A
		5	N/A	N/A	N/A	N/A	2527S	2527P	N/A
		Price	N/A	N/A	N/A	N/A	2527S-I	2527P-I	N/A
	10	MD-21027		MDA4-120S	MDA4-120P	21027S	21027P	N/A	
		Price	D1		MDA4-120S-I	MDA4-120P-I	21027S-I	21027P-I	N/A
	4	N/A	N/A	N/A	N/A	24108S	24108P	N/A	
		Price	N/A	N/A	N/A	24108S-I	24108P-I	N/A	
	6	N/A	N/A	N/A	N/A	26107S	26107P	N/A	
		Price	N/A	N/A	N/A	26107S-I	26107P-I	N/A	
<b>MEK</b>									
MP500, MP600, MP1000		3	N/A	N/A	N/A	N/A	2310S	2310P	D-1310
		Price	N/A	N/A	N/A	N/A	2310S-I	2310P-I	D-1310-I
	5	N/A	N/A	N/A	N/A	2510S	2510P	D-1510	
		Price	N/A	N/A	N/A	N/A	2510S-I	2510P-I	D-1510-I
360697, M160246, MP1000NT		3	N/A	N/A	N/A	N/A	2311S	2311P	D-1311
		Price	N/A	N/A	N/A	N/A	2311S-I	2311P-I	D-1311-I
	5	N/A	N/A	N/A	N/A	2511S	2511P	D-1511	
		Price	N/A	N/A	N/A	N/A	2511S-I	2511P-I	D-1511-I
<b>Mennen</b>									
900, 1110, Horizon 2000, 5200, Horizon 9000XL, MR1200, 1270, 1280, 1300, 1380, 1100, 2100, 2200		3	N/A	N/A	N/A	N/A	2374S	2374P	D-1374
		Price	N/A	N/A	N/A	N/A	2374S-I	2374P-I	D-1374-I
	5	N/A	N/A	N/A	N/A	2574S	2574P	D-1574	
		Price	N/A	N/A	N/A	N/A	2574S-I	2574P-I	D-1574-I
Enmove 1000, Envoy		3	AA-2375		AA3-90S	AA3-90P	2375S	2375P	D-1375
		Price	C4		AA3-90S-I	AA3-90P-I	2375S-I	2375P-I	D-1375-I
	5	AA-2575		AA5-90S	AA5-90P	2575S	2575P	D-1575	
		Price	C5		AA5-90S-I	AA5-90P-I	2575S-I	2575P-I	D-1575-I

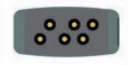
OEM & Models	Monitor Plug	Lead No.	Trunk Cable	Trunk Cable	Lead Wire	Lead Wire	Direct-Conn. Snap	Direct-Conn. Grabber	Din Trunk Cable
<b>Midmark &gt; Cardell</b>									
9403		3	N/A	NA	N/A	N/A	2373S	2373P	D-1373
		Price	N/A	N/A	N/A	N/A	2373S-I	2373P-I	D-1373-I
9403V, 9405, MAX-12 Duo HD, Max-1		3	AA-2340		AA3-90S	AA3-90P	2340S	2340P	D-1340
		Price	C1.4		AA3-90S-I	AA3-90P-I	2340S-I	2340P-I	D-1340-I
	5	AA-2540		AA5-90S	AA5-90P	2540S	2540P	D-1540	
		Price	C3.8		AA5-90S-I	AA5-90P-I	2540S-I	2540P-I	D-1540-I
<b>Mindray &gt; Datascope</b>									
BeneVision, BeneView, iPM, iMEC, uMEC series monitors, BeneHeart defibrillator		3	MR-2312		MRB3-90S	MRB3-90P	2312RS	2312RP	N/A
		Price	C3.8		MRB3-90S-I	MRB3-90P-I	2312RS-I	2312RP-I	N/A
		5	MR-2512		MR5-90S	MR5-90P	2512RS	2512RP	N/A
			Price	C5		MR5-90S-I	MR5-90P-I	2512RS-I	2512RP-I
	10	MR-21012		MRL5-90S	MRL5-90P	21012S	21012P	N/A	
		Price	D1		MRL5-90S-I	MRL5-90P-I	21012S-I	21012P-I	N/A
		3	N/A	N/A	N/A	2312S	2312P	D-1312	
		Price	N/A	N/A	N/A	2312S-I	2312P-I	D-1312-I	
		5	N/A	N/A	N/A	2512S	2512P	D-1512	
			Price	N/A	N/A	N/A	2512S-I	2512P-I	D-1512-I
3		MR-2312EP		MRB3-90S	MRB3-90P	N/A	N/A	N/A	
		Price	C8		MRB3-90S-I	MRB3-90P-I	N/A	N/A	
5	MR-2512EP		MR5-90S	MR5-90P	N/A	N/A	N/A		
	Price	D3		MR5-90S-I	MR5-90P-I	N/A	N/A		
PM, MEC series monitors, Panorama, Passport 2, Spectrum, V-Series, 2000, 2000A, 2001, 2002, 2100, 2200, 3000, 3000A, Ballon Pump, M/D3, M/D3A, M/D4, Passport, PassportL, PassportEL, PassportG, PassportXL, Passport2, Passport2LT, Passport5L, Trio, Spectrum, SpectrumOR, System82, System83, System90, System90T, System96, System97, System 98		3	MR-2340		MRB3-90S	MRB3-90P	2340RS	2340RP	D-1340R
		Price	C3		MRB3-90S-I	MRB3-90P-I	2340RS-I	2340RP-I	D-1340R-I
	5	MR-2540		MR5-90S	MR5-90P	2540RS	2540RP	D-1540R	
		Price	C4		MR5-90S-I	MR5-90P-I	2540RS-I	2540RP-I	D-1540R-I
	3	N/A	N/A	N/A	2340S	2340P	D-1340		
	Price	N/A	N/A	N/A	2340S-I	2340P-I	D-1340-I		
5	N/A	N/A	N/A	N/A	2540S	2540P	D-1540		
	Price	N/A	N/A	N/A	2540S-I	2540P-I	D-1540-I		

Mindray > Datascope Next Page

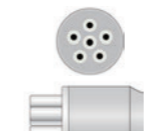
OEM & Models	Monitor Plug	Lead No.	Trunk Cable	Trunk Cable	Lead Wire	Lead Wire	Direct-Conn. Snap	Direct-Conn. Grabber	Din Trunk Cable
<b>Mindray &gt; Datascope</b>									
Passport V, V12, V21	 (defibrillation-proof) 12-pin Connector, Keyed	3	DT-2526		DT3-90S 0012-00-1503-05	DT3-90P 0012-00-1514-05	2326S	2326P	D-1326 040-000072-00
		Price	C5		DT3-90S-I 0012-00-1503-14	DT3-90P-I 0012-00-1514-14	2326S-I	2326P-I	D-1326-I 040-000072-00
		5	DT-2526 0012-00-1745-01		DT5-90S 0012-00-1503-02	DT5-90P 0012-00-1514-02	2526S	2526P	D-1526
		Price	C5		DT5-90S-I 0012-00-1503-11	DT5-90P-I 0012-00-1514-11	2526S-I	2526P-I	D-1526-I
<b>Mortara &gt; Burdick</b>									
CS615, CS625A, CSS20, CSS23, CSS27, CSS7200, EK1, EK2, EK3, EK4, EK5/A/AS, EK8SS, M200, Medic 1, Medic 2, PA-100, PA-104, PA-105	 (defibrillation-proof) 5-pin Connector, Keyed	3	N/A	N/A	N/A	N/A	2305S	2305P	N/A
		Price	N/A		N/A	N/A	2305S-I	2305P-I	N/A
		5	N/A		N/A	N/A	2505S	2505P	N/A
		Price	N/A		N/A	N/A	2505S-I	2505P-I	N/A
<b>NEC</b>									
YCE205	 6-pin Connector, Keyed	3	N/A		NECA3-90S	NECA3-90P	N/A	N/A	N/A
		Price	N/A		NECA3-90S-I	NECA3-90P-I	N/A	N/A	N/A
47502	 4-pin Connector, Keyed	3	N/A		NECB3-90S	NECB3-90P	N/A	N/A	N/A
		Price	N/A		NECB3-90S-I	NECB3-90P-I	N/A	N/A	N/A
47504	 4-pin Connector, Keyed	3	N/A		NECC3-90S	NECC3-90P	N/A	N/A	N/A
		Price	N/A		NECC3-90S-I	NECC3-90P-I	N/A	N/A	N/A
<b>Newtech</b>									
NT3A, NT3B	 12-pin Connector, Keyed	3	AA-2385		AA3-90S	AA3-90P	2385S	2385P	D-1385
		Price	C4		AA3-90S-I	AA3-90P-I	2385S-I	2385P-I	D-1385-I
		5	AA-2585		AA5-90S	AA5-90P	2585S	2585P	D-1585
		Price	C6		AA5-90S-I	AA5-90P-I	2585S-I	2585P-I	D-1585-I
<b>Nihon Kohden</b>									
BSM-7102A, BSM-8301A, BSM-8302A, BSM-8500A, BSM-8502A, BSM-8800A, Life Scope 12, Life Scope 6, Life Scope 7, Life Scope 8, Life Scope 9, MU-831RA, OEC-6102A(s/n<20156), OEC-6105A(s/n<20226), OEC-7102A, OEC-8108A, OMP-7201C, OMP-7203C, TEC-5200A(s/n<20421)	 11-pin Connector, Keyed	3	NK-2507		NKA3-90S	NKA3-90P	2307S	2307P	D-1307
		Price	C3.8		NKA3-90S-I	NKA3-90P-I	2307S-I	2307P-I	D-1307-I
		5	NK-2507		NKA5-90S	NKA5-90P	2507S	2507P	D-1507
		Price	C3.8		NKA5-90S-I	NKA5-90P-I	2507S-I	2507P-I	D-1507-I
OEC-6102A(s/n<20156), OEC-6105A(s/n<20226), OEC-6120A/J/K, TEC-7100K	 8-pin Connector, Keyed	3	NK-2508		NKA3-90S	NKA3-90P	2308S	2308P	D-1308
		Price	C3.8		NKA3-90S-I	NKA3-90P-I	2308S-I	2308P-I	D-1308-I
		5	NK-2508		NKA5-90S	NKA5-90P	2508S	2508P	D-1508
		Price	C3.8		NKA5-90S-I	NKA5-90P-I	2508S-I	2508P-I	D-1508-I
BSM-2300 Life Scope I, BSM-2301, BSM-2351A, BSM-4100 Life Scope P, BSM-4102, BSM-4102A, BSM-4114A, BSM-5100 Life Scope A, BSM-6000 series, BSM-6301K, BSM-6501K, BSM-6701K, BSM-9101, BSM-9510 Life Scope M, BSM-9800 Life Scope S, Life Scope 6700 Series, Life Scope J, Life Scope TR, PVM-2701, BSM-230K	 12-pin Connector, Keyed	3	NK-2509		NKB3-90S K910A/BR-913PA	NKB3-90P K911A/BR-903PA	2309S	2309P	D-1309
		Price	C8.1		NKB3-90S-I K910/BR-913P	NKB3-90P-I K911/BR-903P	2309S-I	2309P-I	D-1309-I
		6	NK-2509		B8	B8	C4	C4	C3.8
		Price	C8.1		NKB6-90P K915A/BR-916PA	NKB6-90P K912A/BR-906PA	2609S	2609P	N/A
			NK-2509-I K922/JC-906P	NKB6-90P-I K915/BR-916	NKB6-90P-I K912/BR-906P	2609S-I	2609P-I	N/A	
			Price	C8.1	C4	C4	C8	C8	N/A







Nihon Kohden Next Page



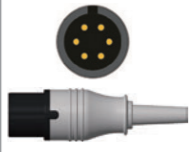

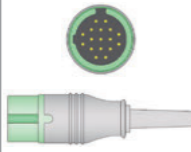





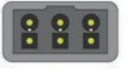

OEM & Models	Monitor Plug	Lead No.	Trunk Cable	Trunk Cable	Lead Wire	Lead Wire	Direct-Conn. Snap	Direct-Conn. Grabber	Din Trunk Cable
<b>Nihon Kohden</b>									
OEC-6102A(s/n<20156), OEC-6105A(s/n<20226), OEC-6120A, OEC-6120J, OEC-6120K, TEC-7621C, TEC-7631C, TEC-7721C, TEC-7731C, TEC-7731K, TEC-7700, Cardiolife Bifasic Defibrillator	 11-pin Connector, Keyed	3	NKB-2313		NKB3-90S	NKB3-90P	2313S	2313P	N/A
		Price	C4		NKB3-90S-I	NKB3-90P-I	2313S-I	2313P-I	N/A
		5	NKB-2513		NKB5-90S	NKB5-90P	2513S	2513P	N/A
		Price	C6.7		NKB5-90S-I	NKB5-90P-I	2513S-I	2513P-I	N/A
OPV-1500	 14-pin Connector, Keyed	3	NKB-2316 JC-1037A		NKB3-90S	NKB3-90P	2316S	2316P	D-1316
		Price	C4		NKB3-90S-I	NKB3-90P-I	2316S-I	2316P-I	D-1316-I
		5	NK-2540		NKA3-90S	NKA3-90P	2340S	2340P	D-1340
		Price	C3.8		NKA3-90S-I	NKA3-90P-I	2340S-I	2340P-I	D-1340-I
BSM-7102A, BSM-7300A, BSM-8108A, BSM-8301A, BSM-8302A, BSM-8500A, BSM-8502A, BSM-8800A, Life Scope 12, Life Scope 6, Life Scope 7, Life Scope 8, Life Scope 9, MU-831RA, OEC-6102A(s/n<20156), OEC-6105A(s/n<20226), OEC-7102A, OEC-8108A, TEC-5531E, TEC-5200A(s/n>20421), TEC-7100A, TEC-7200A, TEC-7300A	 6-pin Connector, Keyed	3	NK-2540		NKA3-90S	NKA3-90P	2340S	2340P	D-1340
		Price	C3.8		NKA3-90S-I	NKA3-90P-I	2340S-I	2340P-I	D-1340-I
		5	NK-2540		NKA5-90S	NKA5-90P	2540S	2540P	D-1540
		Price	C3.8		NKA5-90S-I	NKA5-90P-I	2540S-I	2540P-I	D-1540-I
Novamatrix	 6-pin Connector, Keyed	3	AA-2340		AA3-90S	AA3-90P	2340S	2340P	D-1340
		Price	C1.4		AA3-90S-I	AA3-90P-I	2340S-I	2340P-I	D-1340-I
		5	AA-2540		AA5-90S	AA5-90P	2540S	2540P	D-1540
		Price	C3.8		AA5-90S-I	AA5-90P-I	2540S-I	2540P-I	D-1540-I
BP-308, BP-408, CBM3000, M20, M30, MS20	 6-pin Connector, Keyed	3	AA-2340		AA3-90S	AA3-90P	2340S	2340P	D-1340
		Price	C1.4		AA3-90S-I	AA3-90P-I	2340S-I	2340P-I	D-1340-I
		5	AA-2540		AA5-90S	AA5-90P	2540S	2540P	D-1540
		Price	C3.8		AA5-90S-I	AA5-90P-I	2540S-I	2540P-I	D-1540-I
BP-S510, BP-88S, Press Mate Advantage	 6-pin Connector, Keyed	3	CL-2520		CL3-90S	CL3-90P	2320S MC039-55	2320P	D-1320
		Price	C4		CL3-90S-I	CL3-90P-I	2320S-I	2320P-I	D-1320-I
		5	CL-2520		CL5-90S	CL5-90P	2520S	2520P	N/A
		Price	C4		CL5-90S-I	CL5-90P-I	2520S-I	2520P-I	N/A
BP88, BP306	 6-pin Connector, Keyed	3	CL-2521		CL3-90S	CL3-90P	2321S	2321P	D-1321
		Price	C4		CL3-90S-I	CL3-90P-I	2321S-I	2321P-I	D-1321-I
		5	CL-2521		CL5-90S	CL5-90P	2521S	2521P	N/A
		Price	C4		CL5-90S-I	CL5-90P-I	2521S-I	2521P-I	N/A



OEM & Models	Monitor Plug	Lead No.	Trunk Cable	Trunk Cable	Lead Wire	Lead Wire	Direct-Conn. Snap	Direct-Conn. Grabber	Din Trunk Cable
<b>PaceTech</b>									
2100, 2200, 4000, 4100, MiniMax 4000CL, Minipack 300, Minipack 3000, Minipack 3000/3100, Minipack 3100, Modular/4100CL, Vitalmax 2100, Vitalmax 2200, Vitalmax 4000, Vitalmax 4000 Modular, Vitalmax 4000CL, Vitalmax 4100, Vitalmax 4100CL, Vitalmax 800 Plus		3	AA-2340		AA3-90S	AA3-90P	2340S	2340P	D-1340
		Price	AA-2340-I		AA3-90S-I	AA3-90P-I	2340S-I	2340P-I	D-1340-I
		5	AA-2540		AA5-90S	AA5-90P	2540S	2540P	D-1540
		Price	AA-2540-I		AA5-90S-I	AA5-90P-I	2540S-I	2540P-I	D-1540-I
<b>Penlon InterMed</b>									
PM-9000		3	MR-2312		MRB3-90S	MRB3-90P	2312S	2312P	D-1312
		Price	MR-2312-I		MRB3-90S-I	MRB3-90P-I	2312S-I	2312P-I	D-1312-I
		5	MR-2512		MR5-90S	MR5-90P	2512S	2512P	D-1512
		Price	MR-2512-I		MR5-90S-I	MR5-90P-I	2512S-I	2512P-I	D-1512-I
<b>Petas</b>									
165R, 260R, 300, K-250, KMA160R		3	N/A	N/A	N/A	N/A	24026S	24026P	N/A
		Price	N/A	N/A	N/A	N/A	24026S-I	24026P-I	N/A
<b>Philips</b>									
43011A, 77000AC, 77020A, 77020AC, 77020AR, 77025A, 77030A, 77035A, 77040A, 78200A, 78210A, 78220A, 78230A, 78230A Series, 78330A, 78331A, 78332A, 78333A, 78341A, 78342A, 78345A, 78346A, 78351T, 78352A, 78353A, 78353B, 78354A, 78354A Series, 78532A, 78532B, 78534A, 78534B, 78534C, 785xxA, 785xxB, 785xxC, 786xxA, 786xxB, Agilent Sonos 5500, Codemaster XL, M1722A, M1722B, M1723A, M1723B, M2400A, M2405A, M2475B, M2500B, HeartStart VLT		3	AA-23029		AAB3-90S	AAB3-90P	23029S	23029P	D-13029
		Price	AA-23029-I		AAB3-90S-I	AAB3-90P-I	23029S-I	23029P-I	D-13029-I
		5	AA-25029		AAB5-90S	AAB5-90P	25029S	25029P	D-15029
		Price	AA-25029-I		AAB5-90S-I	AAB5-90P-I	25029S-I	25029P-I	D-15029-I
43100A, 43110A, 43120A, 78352C, 78354A/C, 78354C, 78354A/B/C, 78834C, 862472, 862473, 862474, 862474 C3, 862475, 862476, 862479, 86306A, 863065, 863066, 863066, Agilent, Agilent 500M, C Series, C3, C350, Enviro, HD15, HeartStart MRx, HeartStart XL, Heartstart, IE33, IntelliVue MX800, M1001A, M1001B, M1002A, M1002B, M1165A, M1166A, M1167A, M1175A, M1177A, M1204A, M1205A, M1264A, M1275A Transport, M1276A, M1280A, M1222A, M1222B, M1273A, M1273B, M2, M2475B, M2601A, M3, M3000A, M3001A, M3002A MMS X2, M3535A, M3536A, M4, M4735A, M6102A MP2, M8105A MP5, MP 20, MP 30, MP 50, MP 60, MP 70, Merlin, SureSigns VM6, SureSigns VM8, V24, V24E, V26, Viridia, M3046A		3	AA-2385		AAB3-90S	AAB3-90P	2385S	2385P	D-1385
		Price	AA-2385-I		AAB3-90S-I	AAB3-90P-I	2385S-I	2385P-I	D-1385-I
		5	AA-2585		AAB5-90S	AAB5-90P	2585S	2585P	D-1585
		Price	AA-2585-I		AAB5-90S-I	AAB5-90P-I	2585S-I	2585P-I	D-1585-I
Multi-Measurement Modules: M3001A, M3002A, MP2: M8102A, MP5: M8105A, SureSigns Monitors: 863065, 863066, 863068, 863317 Efficia Monitors: 863300, 863301, 863302, 863303, 863304, 863320, 863321, 863322 Defibrillator: DFM 100, Efficia CM12 (863303), CM120 (863302), CM150 (863304)		3	HP-2385E		HP3-90S	HP3-90P	2385S	2385P	D-1385
		Price	HP-2385E-I		HP3-90S-I	HP3-90P-I	2385S-I	2385P-I	D-1385-I
		5	HP-2585E		HP5-90/150ES	HP5-90/150EP	N/A	N/A	N/A
		Price	HP-2585E-I		HP5-90/150ES-I	HP5-90/150EP-I	N/A	N/A	N/A
M3000A, M3001A, M8102A MP2, M1001A, M1001B, M1002A, M1002B, M3002A X2, M8105A MP5		3	PT-2685		PT3-90S	PT3-90P	2385S	2385P	D-1385
		Price	PT-2685-I		PT3-90S-I	PT3-90P-I	2385S-I	2385P-I	D-1385-I
		5	PT-2685		PT5-90S	PT5-90P	2585S	2585P	D-1585
		Price	PT-2685-I		PT5-90S-I	PT5-90P-I	2585S-I	2585P-I	D-1585-I
Multi-Measurement Modules: M3000A, M3001A Opt C12 or Opt C18, M3002A Opt C12 or Opt C18, MP5: M8105A Opt C12, MP2: M8102A Opt C12, ECG Modules: M1001B, M1002B, 860335, 860338		3	AA-2340		AA3-90S	AA3-90P	2340S	2340P	D-1340
		Price	AA-2340-I		AA3-90S-I	AA3-90P-I	2340S-I	2340P-I	D-1340-I
		5	AA-2540		AA5-90S	AA5-90P	2540S	2540P	D-1540
		Price	AA-2540-I		AA5-90S-I	AA5-90P-I	2540S-I	2540P-I	D-1540-I

OEM & Models	Monitor Plug	Lead No.	Trunk Cable	Trunk Cable	Lead Wire	Lead Wire	Direct-Conn. Snap	Direct-Conn. Grabber	Din Trunk Cable
<b>Primedic</b>									
DM 10, DM 30		4	N/A	N/A	N/A	N/A	2415S	2415P	N/A
		Price	N/A	N/A	N/A	N/A	2415S-I	2415P-I	N/A
		Price	N/A	N/A	N/A	N/A	C8.9	C8.9	N/A
<b>Schiller</b>									
ARGUS LCM, AGGUS LCM PLUS		3	SM-2354		SM3-90S	SM3-90P	2354S	2354P	N/A
		Price	SM-2354-I		SM3-90S-I	SM3-90P-I	2354S-I	2354P-I	N/A
		5	SM-2554		SM5-90S	SM5-90P	2554S	2554P	N/A
		Price	SM-2554-I		SM5-90S-I	SM5-90P-I	2554S-I	2554P-I	N/A
Defigard 5000 Defigard 4000		3	SM-23112		SM3-90S	SM3-90P	23112S	23112P	N/A
		Price	SM-23112-I		SM3-90S-I	SM3-90P-I	23112S-I	23112P-I	N/A
Defigard 5000 Defigard 4000		4	N/A	N/A	N/A	N/A	2454S	2454P	N/A
		Price	N/A	N/A	N/A	N/A	2454S-I	2454P-I	N/A
DEFIGARD Touch 7, DEFIGARD HD-7, PHYSIOGARD HD-7, ARGUS PRO LifeCare 2		4	N/A	N/A	N/A	N/A	24130S	24130P	N/A
		Price	N/A	N/A	N/A	N/A	24130S-I	24130P-I	N/A
		10	24131S/24131P		26107S	26107P	N/A	N/A	N/A
		Price	24131S-I/24131P-I		26107S-I	26107P-I	N/A	N/A	N/A
TRUSCOPE elite A8/A5/A3		3	HP-2367		HP3-90S	HP3-90P	2367S	2367P	D-1367
		Price	HP-2367-I		HP3-90S-I	HP3-90P-I	2367S-I	2367P-I	D-1367-I
		5	HP-2567		HPA5-90S	HPA5-90P	2567S	2567P	D-1567
		Price	HP-2567-I		HPA5-90S-I	HPA5-90P-I	2567S-I	2567P-I	D-1567-I
<b>Sigowill/Bistos/Lutech</b>									
Bistos: BT-740, BT-770, BT-780 Lutech: Datalys 805/807		5	MQ-25118R		MQ5-90S	MQ5-90P	25118S	25118P	N/A
		Price	MQ-25118R-I		MQ5-90S-I	MQ5-90P-I	25118S-I	25118P-I	N/A
<b>Sinohero</b>									
AcuitSign M6		3	HP-2367		HP3-90S	HP3-90P	2367S	2367P	D-1367
		Price	HP-2367-I		HP3-90S-I	HP3-90P-I	2367S-I	2367P-I	D-1367-I
		5	HP-2567		HPA5-90S	HPA5-90P	2567S	2567P	D-1567
		Price	HP-2567-I		HPA5-90S-I	HPA5-90P-I	2567S-I	2567P-I	D-1567-I
<b>Skanray &gt; Larsen &amp; Toubro</b>									
Cosmic, Galaxy, Planet, Planet 50, Star 50, Star 55, Stellar P		3	SM-2398		SM3-90S	SM3-90P	2398S	2398P	D-1398
		Price	SM-2398-I		SM3-90S-I	SM3-90P-I	2398S-I	2398P-I	D-1398-I
		5	SM-2598		SM5-90S	SM5-90P	2598S	2598P	D-1598
		Price	SM-2598-I		SM5-90S-I	SM5-90P-I	2598S-I	2598P-I	D-1598-I
<b>Smiths Medical &gt; BCI</b>									
Cosmic, Galaxy, Planet, Planet 50, Star 50, Star 55, Stellar P		3	AA-2340		AA3-90S	AA3-90P	2340S	2340P	D-1340
		Price	AA-2340-I		AA3-90S-I	AA3-90P-I	2340S-I	2340P-I	D-1340-I
		5	AA-2540		AA5-90S	AA5-90P	2540S	2540P	D-1540
		Price	AA-2540-I		AA5-90S-I	AA5-90P-I	2540S-I	2540P-I	D-1540-I

OEM & Models	Monitor Plug	Lead No.	Trunk Cable	Trunk Cable	Lead Wire	Lead Wire	Direct-Conn. Snap	Direct-Conn. Grabber	Din Trunk Cable	
<b>Spacelabs</b>										
400, 500, 600, 67112, 900, 90300, 90303, 90303B, 90308, 90400, 90408, 90425, 90428, 90431, 90432, 90470, 90600, 90603A, 90700, 90701, 90721, 90724, AriaTele, Medic 3, Medic 4, Medic 5, Medic 6, PC Bedside, PCMS, Series 500, Series 600, Series 900, TEK-208, TEK-208/408/511/512/514/521, TEK-408, TEK-413, TEK-414, TEK-511, TEK-512, TEK-514, TEK-5214045		3	SL-2340		SL3-90S	SL3-90P	2340S	2340P	D-1340	
		Price	C1.4		SL3-90S-I	SL3-90P-I	2340S-I	2340P-I	D-1340-I	
		5	SL-2540		SL5-90S	SL5-90P	2540S	2540P	D-1540	
			SL-2540-I		SL5-90S-I	SL5-90P-I	2540S-I	2540P-I	D-1540-I	
		Price	C3.8		C2	C2	C5	C5	C2	
		90309, 90367 Ultraview, 90369 Ultraview, 90496 Ultraview, 91220 mCare 300, 91369, 93300, Elance Series, Ultraview SL, 90367, 90369, 90492, 90496, 91496, Ultraview			3	HPC-2696 700-0008-55	HPC3-90S 700-0007-35	HPC3-90P 700-0006-35	2396S	2396P
HPC-2696-I	HPC3-90S-I 700-0007-41			HPC3-90P-I 700-0006-41		2396S-I	2396P-I	D-1396-I		
Price	C7			B8	B8	C5	C5	C3.8		
5	HPC-2696 700-0008-57			HPC5-90S 700-0007-37	HPC5-90P 700-0006-37	2596S	2596P	D-1596		
	HPC-2696-I			HPC5-90S-I 700-0007-43	HPC5-90P-I 700-0006-43	2596S-I	2596P-I	D-1596-I		
Price	C7			C2	C2	C8.1	C8.1	C5		
6	HPC-2696 700-0008-59			HPC6-90S 700-0007-39	HPC6-90P 700-0006-39	2696S	2696P	N/A		
	HPC-2696-I			HPC6-90S-I	HPC6-90P-I	2696S-I	2696P-I	N/A		
Price	C7			C3.8	C3.8	C8.3	C8.3	N/A		
3	SL-2396			SL3-90S	SL3-90P	2396S	2396P	D-1396		
	SL-2396-I			SL3-90S-I	SL3-90P-I	2396S-I	2396P-I	D-1396-I		
Price	C4			B7	B7	C5	C5	C2		
5	SL-2596	SL5-90S	SL5-90P	2596S	2596P	D-1596				
	SL-2596-I	SL5-90S-I	SL5-90P-I	2596S-I	2596P-I	D-1596-I				
Price	C5	C2	C2	C8.1	C8.1	C2				
Ultraview 90492/ 90496/91496/90470		10	MQ-21096	MQ5-90S MV5-90S	MQ5-90P MV5-90P	21096S	21096P	N/A		
			MQ-21096-I	MQ5-90S-I MV5-90S-I	MQ5-90P-I MV5-90P-I	21096S-I	21096P-I	N/A		
Price	D3	C3.8*2	C3.8*2	DD1.3	DD1.3	N/A				
<b>Saadat/Siare/Heyer Medical</b>										
Saadat: S1600, S1800 Siare: NEPTUNE 12 (HBOT) Heyer Medical: VIZOR		3	N/A	N/A	N/A	N/A	23114RS	23114RP	N/A	
			N/A		N/A	N/A	23114RS-I	23114RP-I	N/A	
		Price	N/A		N/A	N/A	N/A	C6.7	C6.7	N/A
		5	N/A		N/A	N/A	25114RS	25114RP	N/A	
N/A	N/A		N/A	25114RS-I	25114RP-I	N/A				
Price	N/A	N/A	N/A	C8.2	C8.2	N/A				
<b>Sonoscape</b>										
SSI-6000		5	N/A	N/A	N/A	N/A	2351S	2351P	N/A	
		N/A	N/A		N/A	2351S-I	2351P-I	N/A		
Price	N/A	N/A	N/A	C5	C5	N/A				
<b>SJM(ST. JUDE MEDICAL)</b>										
MODEL 3626		5	N/A	N/A	N/A	N/A	25128S-Z	25128P-Z	N/A	
		N/A	N/A		N/A	25128S-I-Z 10005407	25128P-I-Z	N/A		
Price	N/A	N/A	N/A	D5.1.4	D5.1.4	N/A				

OEM & Models	Monitor Plug	Lead No.	Trunk Cable	Trunk Cable	Lead Wire	Lead Wire	Direct-Conn. Snap	Direct-Conn. Grabber	Din Trunk Cable
<b>Welch Allyn</b>									
1500, Atlas, Atlas 6200 Series, PIC 30, PIC 40, PIC 50, Propaq 100 Series, Propaq 200 Series, Propaq CS, Propaq Encore, Ultra Smart		3	AA-2340R		AA3-90S	AA3-90P	2340RS	2340RP	D-1340R
		Price	C3.8		AA3-90S-I	AA3-90P-I	2340RS-I	2340RP-I	D-1340R-I
Micropaq, Propaq LT		3	N/A	N/A	N/A	N/A	2353S 008-0890-00	2353P	D-1353 008-0892-00
			N/A		N/A	2353S-I	2353P-I	D-1353-I	
		Price	N/A		N/A	N/A	C5	C5	C3.8
		5	N/A		N/A	N/A	2553S 008-0879-00	2553P	D-1553 008-0881-00
			N/A		N/A	N/A	2553S-I	2553P-I	D-1553-I
		Price	N/A		N/A	N/A	C8.1	C8.1	C5
1500		10	N/A	N/A	N/A	N/A	21079S	21079P	N/A
		Price	N/A		N/A	N/A	21079S-I	21079P-I	N/A
							DD1	DD1	N/A
<b>Zoll</b>									
D900, PD1200, PD1400, PD1600, PD1700, PD2000, R Series		3	AA-2340R		AA3-90S	AA3-90P	2340RS	2340RP	D-1340R
		Price	C3.8		AA3-90S-I	AA3-90P-I	2340RS-I	2340RP-I	D-1340R-I
E Series M Series		10	N/A	N/A	N/A	N/A	21069S	21069P	N/A
		Price	N/A		N/A	N/A	21069S-I	21069P-I	N/A
E Series M Series		4	N/A		N/A	N/A	24109S	24109P	N/A
		Price	N/A		N/A	N/A	24109S-I	24109P-I	N/A
X Series		6	N/A	N/A	N/A	N/A	26110P	26110P	N/A
		Price	N/A		N/A	N/A	26110P-I	26110P-I	N/A
X Series		10	N/A	N/A	N/A	N/A	21079S	21079P	N/A
		Price	N/A		N/A	N/A	21079S-I	21079P-I	N/A
X Series		4	N/A		N/A	N/A	2479S	2479P	N/A
		Price	N/A		N/A	N/A	2479S-I	2479P-I	N/A
		6	N/A	N/A	N/A	N/A	2679P	2679P	N/A
		Price	N/A		N/A	N/A	2679P-I	2679P-I	N/A
							C8	C8	N/A

\*One piece cables with neonate electrode end for most brands are available upon request.  
 \*For neonate application, Din style neonate leads are also the alternatives.







## 1.2 ECG Lead Wires

Types of Major ECG Lead Wires	Lead No.	REF# Snap(AHA/IEC)	OEM REF#	Price (unit)	REF# Grabber(AHA/IEC)	OEM REF#	Price (unit)
<b>Din Unshielded Individual Set Leads</b>							
	3	D3-90S		B4	D3-90P		B4
		D3-90S-I			D3-90P-I		
	5	D5-90S		B6.6	D5-90P		B6.6
		D5-90S-I			D5-90P-I		
	7	D7-90S		C1.3	D7-90P		C1.3
		D7-90S-I			D7-90P-I		
	10	D10-90S		C5	D10-90P		C5
		D10-90S-I			D10-90P-I		
<b>Din Unshielded Individual Set Leads (For Neonate, Mini Grabber)</b>							
	3				D3-90NP		B4.1
					D3-90NP-I		
	5				D5-90NP		B6.7
					D5-90NP-I		
<b>LL Sryle Individual Set Leads</b>							
	3	LL3-90S		B6.5	LL3-90P		B6.5
		LL3-90S-I			LL3-90P-I		
	5	LL5-90S		C1.4	LL5-90P		C1.4
		LL5-90S-I			LL5-90P-I		
<b>Draeger / Dräger Integrated Leads</b>							
	3	DG3-90S		C2	DG3-90P	MS16231, MP03402	C2
		DG3-90S-I			DG3-90P-I	MS16159, MP03401	
	5	DG5-90S		C4	DG5-90P	MS16546, MP03404	C4
		DG5-90S-I			DG5-90P-I	MS16158, MP03403	
	6	DG6-90S		C5	DG6-90P	MS16547, MP03406	C5
		DG6-90S-I			DG6-90P-I	MS16157, MP03405	
<b>Draeger &gt; Siemens Integrated Leads</b>							
	3	SM3-90S		B7.9	SM3-90P		B7.9
		SM3-90S-I			SM3-90P-I		
	3	SMB3-90S		C1.3	SMB3-90P	MP03412	C1.3
		SMB3-90S-I			SMB3-90P-I	MP03411	
	5	SM5-90S		C3.8	SM5-90P	MP03414	C3.8
		SM5-90S-I			SM5-90P-I	MP03413	

Types of Major ECG Lead Wires	Lead No.	REF# Snap(AHA/IEC)	OEM REF#	Price (unit)	REF# Grabber(AHA/IEC)	OEM REF#	Price (unit)	
<b>Draeger &gt; Siemens Individual Set Leads</b>								
	3	SMD3-90S		B7.9	SMD3-90P		B7.9	
		SMD3-90S-I			SMD3-90P-I			
	3	SMF3-90S		C1.3	SMF3-90P	5956433	C1.3	
		SMF3-90S-I			SMF3-90P-I	5956441		
	5	SMD5-90S		C3.8	SMD5-90P	5956466	C3.8	
		SMD5-90S-I			SMD5-90P-I	5956458		
<b>GE Datex - Ohmeda Integrated Leads (Dx300 Series)</b>								
	3	DX3-90S	545327-HEL(75cm)	B7	DX3-90P	545317-HEL(75cm), 8001958(150cm)	B7	
		DX3-90S-I			DX3-90P-I			
	5	DX5-90S	545328(75cm)	C2	DX5-90P	8001959-HEL(150cm), 545318(Mixed)	C2	
		DX5-90S-I			DX5-90P-I			
<b>GE Datex - Ohmeda Individual Set Leads (Dx300 Series)</b>								
	3	DXB3-90S		C1.4	DXB3-90P		C1.4	
		DXB3-90S-I			DXB3-90P-I			
	5	DXB5-90S		C6.7	DXB5-90P		C6.7	
		DXB5-90S-I			DXB5-90P-I			
<b>GE Marquette Integrated Leads (Multi-Link)</b>								
	3	MQ3-90S	411203-001(75cm), 411203-002(130cm)	B8.1	MQ3-90P	412682-001(74cm), 412682-002(130cm)	B8.1	
		MQ3-90S-I	411203-003(75cm), 411203-004(130cm)		MQ3-90P-I	412682-003(74cm), 412682-004(130cm)		
	5	MQ5-90S	411202-001(75cm), 411202-002(130cm)	C3.8	MQ5-90P	412681-001(75cm), 412681-002(130cm)	C3.8	
		MQ5-90S-I	411200-003(75cm), 411200-004(130cm)		MQ5-90P-I	414556-003(75cm), 414556-004(130cm)		
	5	MV5-90S		C3.8	MV5-90P		C3.8	
		MV5-90S-I			MV5-90P-I			
<b>GE Marquette Individual Set Leads (Multi-link)</b>								
	5	MQB5-90S	411200-001(75cm), 411200-002(130cm)	C3.8	MQB5-90P	414556-001(75cm), 414556-002(130cm)	C3.8	
		MQB5-90S-I	411200-003(75cm), 411200-004(130cm)		MQB5-90P-I	414556-003(75cm), 414556-004(130cm)		
	6	MQB6-90S	421932-001(75cm), 421932-002(130cm)	C4	MQB6-90P	421930-001(75cm), 421930-002(130cm)	C4	
		MQB6-90S-I			MQB6-90P-I			
	<b>GE Marquette Integrated Leads (only use with GE Carescape ONE)</b>							
		4	MQB4-90S	2066468-001(74cm), 2066468-005(130cm)	C2	MQB4-90P	2066468-003(74cm), 2066468-007(130cm)	C2
		MQB4-90S-I	2066468-002(74cm), 2066468-006(130cm)		MQB4-90P-I	2066468-004(74cm), 2066468-008(130cm)		
<b>Meditronic &gt; Physio Control Integrated Leads</b>								
	4	MDA4-120S	11110-000102, 805265-03	C1	MDA4-120P		C1	
		MDA4-120S-I			MDA4-120P-I			
	6	MDB6-90S	11110-000103, 805265-04	C5	MDB6-90P		C5	
		MDB6-90S-I			MDB6-90P-I			
<b>Mindray &gt; Datascope Integrated Leads</b>								
	3	DT3-90S	0012-00-1503-04(45cm), 0012-00-1503-05(61cm), 0012-00-1503-06(101cm)	B8.1	DT3-90P	0012-00-1514-04(45cm), 0012-00-1514-05(61cm), 0012-00-1514-06(101cm)	B8.1	
		DT3-90S-I			DT3-90P-I			
	5	DT5-90S	0012-00-1503-01(45cm), 0012-00-1503-02(61cm), 0012-00-1503-03(101cm)	C4	DT5-90P	0012-00-1514-01(45cm), 0012-00-1514-02(61cm), 0012-00-1514-03(101cm)	C4	
		DT5-90S-I			DT5-90P-I			

Types of Major ECG Lead Wires	Lead No.	REF# Snap(AHA/IEC)	OEM REF#	Price (unit)	REF# Grabber(AHA/IEC)	OEM REF#	Price (unit)
<b>Mindray Integrated Leads</b>							
	3	MRB3-90S		B7.9	MRB3-90P		B7.9
		MRB3-90S-I			MRB3-90P-I		
	3 (3-lead wires with 5 connectors)	MR3-90S	0012-00-1261-07/08/09	C1	MR3-90P	0012-00-1262-07/08/09	C1
		MR3-90S-I			MR3-90P-I		
	5	MR5-90S		C3	MR5-90P		C3
		MR5-90S-I			MR5-90P-I		
	5 (Limb) (Gray)	MRL5-90S	EL6801B,0010-30-42906	C3	MRL5-90P	EL6801A,0010-30-42902	C3
		MRL5-90S-I	EL6802B,0010-30-42907		MRL5-90P-I	EL6802A,0010-30-42903	
	3 (Chest) (C2-C6,V2-V6) (Brown)	MRP5-90S	EL6803B,0010-30-42908	C3	MRP5-90P	EL6803A,0010-30-42904	C3
		MRP5-90S-I	EL6804B,0010-30-42909		MRP5-90P-I	EL6804A,0010-30-42905	
<b>Mindray Individual Set Leads</b>							
	3	MRC3-90S		B7	MRC3-90P		B7
		MRC3-90S-I			MRC3-90P-I		
	3 (3-lead wires with 5 connectors)	MRD3-90S	EL6301B,0010-30-42734	C1	MRD3-90P	EL6303A,EL6301A,0010-30-42731,0010-30-42726	C1
		MRD3-90S-I	EL6302B,0010-30-42733		MRD3-90P-I	EL6304A,EL6302A,0010-30-42732,0010-30-42725	
	5	MRC5-90S	EL6501B,0010-30-42735	C2	MRC5-90P	EL6501A,EL6503A,0010-30-42727,0010-30-42729	C2
		MRC5-90S-I	EL6502B,0010-30-42736		MRC5-90P-I	EL6502A,EL6504A,0010-30-42728,0010-30-42730	
<b>Nihon Kohden Integrated Leads</b>							
	3	NKA3-90S	BR-019PA,K226A	B8	NKA3-90P	BR-018PA,K225A	B8
		NKA3-90S-I	BR-019P,K226		NKA3-90P-I	BR-019P,K225	
	5	NKA5-90S		C3	NKA5-90P		C3
		NKA5-90S-I			NKA5-90P-I		
	2	NKB2-90S	BR-902PA,K907B	B6.7	NKB2-90P	BR-912PA,K908B	B6.7
		NKB2-90S-I	BR-902P,K907A		NKB2-90P-I	BR-912P,K908A	
	3	NKB3-90S	BR-913PA,K910B	B8	NKB3-90P	BR903PA,K911A	B8
		NKB3-90S-I	BR-913P,K910A		NKB3-90P-I	BR903P,K911	
	6	NKB6-90S	BR-916PA, K915A	C4	NKB6-90P	BR-906PA, K912A	C4
		NKB6-90S-I	BR-916P, K915		NKB6-90P-I	BR-906P, K912	
<b>Philips Integrated Leads</b>							
	3	AA3-90S		B7	AA3-90P		B7
		AA3-90S-I			AA3-90P-I		
	5	AA5-90S		C2	AA5-90P		C2
		AA5-90S-I			AA5-90P-I		
<b>Philips Individual Set Leads</b>							
	3	AAB3-90S	M1605A, 989803104381	B6.7	AAB3-90P	M1603A, 989803104371	B6.7
		AAB3-90S-I	M1615A		AAB3-90P-I	M1613A, 989803104451	
	5	AAB5-90S	M1625A, 989803104521	C1.4	AAB5-90P	M1623A, 989803104511	C1.4
		AAB5-90S-I	M1635A		AAB5-90P-I	M1633A, 989803104571	

Types of Major ECG Lead Wires	Lead No.	REF# Snap(AHA/IEC)	OEM REF#	Price (unit)	REF# Grabber(AHA/IEC)	OEM REF#	Price (unit)
<b>Philips IntelliVue Integrated Leads(For use in operating room)</b>							
	3	HP3-90ES		C2	HP3-90EP	M1675A	C2
		HP3-90ES-I			HP3-90EP-I	M1678A	
	5	HP5-90/150ES		C4	HP5-90/150EP	M1973A	C4
		HP5-90/150ES-I			HP5-90/150EP-I	M1974A	
<b>Philips IntelliVue Integrated Leads</b>							
	3	HP3-90S	M1673A, 989803145111, 989803133831	C1.4	HP3-90P	M1671A, 989803145091, 989803133841, 453561490141	C1.4
		HP3-90S-I	M1674A, 989803145121		HP3-90P-I	M1672A, 989803145101	
	3	HPA5-90S	M1644A, 989803144991	C3.8	HPA5-90P	M1968A, 989803125841	C3.8
		HPA5-90S-I	M1645A, 989803145001		HPA5-90P-I	M1971A, 989803125851	
	5 (Chest) (C2-C6,V2-V6) (Red)	HPB5-90S	M1602A, 989803144911, 989803176171	C3.8	HPB5-90P	M1976A, 989803125881	C3.8
		HPB5-90S-I	M1604A, 989803144921		HPB5-90P-I	M1978A, 989803125891	
	6	HPA6-90/150S	M1682A, 989803145181	C4	HPA6-90/150P	M1680A, 989803145161	C4
		HPA6-90/150S-I	M1683A		HPA6-90/150P-I	M1681A, 989803145171	
<b>Spacelabs Integrated Leads</b>							
	3	SL3-90S		B7	SL3-90P		B7
		SL3-90S-I			SL3-90P-I		
	5	SL5-90S		C2	SL5-90P		C2
		SL5-90S-I			SL5-90P-I		
<b>Spacelabs Individual Set Leads</b>							
	3	SLB3-90S	700-0007-00(61cm) 700-0007-02(102cm)	B6.7	SLB3-90P	700-0006-00(61cm) 700-0006-02(102cm)	B6.7
		SLB3-90S-I	700-0007-01(61cm) 700-0007-03(102cm)		SLB3-90P-I	700-0006-01(61cm) 700-0006-03(102cm)	
	4	SLB4-90S	700-0007-04(61cm) 700-0007-06(102cm)	C1.3	SLB4-90P	700-0006-04(61cm) 700-0006-06(102cm)	C1.3
		SLB4-90S-I	700-0007-05(61cm) 700-0007-07(102cm)		SLB4-90P-I	700-0006-05(61cm) 700-0006-07(102cm)	
	5	SLB5-90S	700-0007-08(61cm) 700-0007-10(102cm)	C3.8	SLB5-90P	700-0006-08(61cm) 700-0006-10(102cm)	C3.8
		SLB5-90S-I	700-0007-09(61cm) 700-0007-11(102cm)		SLB5-90P-I	700-0006-09(61cm) 700-0006-11(102cm)	
	3	HPC3-90S	700-0007-35(74cm) 700-0010-18(130cm)	B8	HPC3-90P	700-0006-35(74cm) 700-0010-01(130cm)	B8
		HPC3-90S-I	700-0007-41(74cm)		HPC3-90P-I	700-0006-41(74cm)	
	5	HPC5-90S	700-0007-37(74cm) 700-0010-19(130cm)	C2	HPC5-90P	700-0006-37(74cm) 700-0010-01(130cm)	C2
		HPC5-90S-I	700-0007-44(74cm)		HPC5-90P-I	700-0006-43(74cm)	
	6	HPC6-90S	700-0007-39(74cm)	C3.8	HPC6-90P	700-0006-39(74cm)	C3.8
		HPC6-90S-I			HPC6-90P-I		





## 2 Telemetry ECG Cables and Holter ECG Cables

### Specification

Cable material	TPU Jacket, Light gray
Connector & Yoke	Nylon plug & Golden plated pins
Lead wire length	0.9m or longer

### Compatibility

Major brands ECG transmitter & Holter system

Compatibility: Manufacturer & Model	Photo	Lead#	Unimed REF#	OEM REF#	Price (unit)
Bi-biomed BI6603, BI6612, BI6803, BI6812, BI9000, BI9800		10	H10BI01S-A	H2111	C8.6
			H10BI01S-I		
Creative PC-80 Easy ECG Monitor 2.5mm jack plug		3	H253-90S H253-90P		B6
			H253-90S-I H253-90P-I		
DMS DMS300-3A		5	H05DM02S-A H05DM02S-I		C3.8
		7	H07DM02S-A H07DM02S-I		C6
DMS DMS300-4A		7	H07DM01S-A H07DM01S-I		C6
		10	H10DM01S-A H10DM01S-I		D3.8
Edan SE-2003, SE-2012		7	ED7-120S ED7-120S-I		C8
Fukuda Denshi LX-5120, LX-5160 LX-7120, LX-7230N		3	FKD3-90S FKD3-90P		C2
			FKD3-90S-I FKD3-90P-I		
		4	FKD4-90S FKD4-90P		C4
			FKD4-90S-I FKD4-90P-I		
		5	FKD5-90S FKD5-90P		C5
			FKD5-90S-I FKD5-90P-I		
GE Healthcare Aprepro FH		3	AP3-90S AP3-90P	394111-014 394111-013	C4
			AP3-90S-I AP3-90P-I		
		5	AP5-90S AP5-90P	394111-012, 394111-006 394111-005, 394111-011	C6
			AP5-90S-I AP5-90P-I		
		6	AP6-90S AP6-90P	394111-010 394111-009	C8.1
			AP6-90S-I AP6-90P-I		
GE Healthcare ApexPro CH		6	MQB6-90S MQB6-90P	421932-001(75cm), 421932-002(130cm) 421930-001(75cm), 421930-002(130cm)	C4
			MQB6-90S-I MQB6-90P-I		
GE Healthcare SEER Light		5	H05GE01S-A H05GE01P-A	2008594-001	D3
			H05GE01S-I H05GE01P-I	2008594-003	
		7	H07GE01S-A H07GE01P-A	2008594-002	D3.4
			H07GE01S-I H07GE01P-I	2008594-004	

Compatibility: Manufacturer & Model	Photo	Lead#	Unimed REF#	OEM REF#	Price (unit)
Meigaoyi MGY-M1 <b>Landcom</b> Visual Stethoscope		3	<b>H253-90S</b> <b>H253-90P</b>		B6
			<b>H253-90S-I</b> <b>H253-90P-I</b>		
Mindray Tel-100, TMS-6016		5	<b>TM5-90S</b> <b>TM5-90P</b>	115-004869-00/EY6502B 115-004873-00/EY6502A	C5
			<b>TM5-90S-I</b> <b>TM5-90P-I</b>	115-004870-00/EY6501B 115-004874-00/EY6501A	
☆ Mindray TD60, TM80		3	<b>MRA3-90S</b> <b>MRA3-90P</b>	009-004765-00/009-004766-00 009-004771-00/009-004772-00	C2
			<b>MRA3-90S-I</b> <b>MRA3-90P-I</b>	009-004768-00/009-004769-00 009-004774-00/009-004775-00	
		5	<b>MRA5-90S</b> <b>MRA5-90P</b>	009-004782-00/009-004783-00 009-004786-00/009-004787-00	C6
			<b>MRA5-90S-I</b> <b>MRA5-90P-I</b>	009-004784-00/009-004785-00 009-004788-00/009-004789-00	
		6	<b>MRA6-90S</b> <b>MRA6-90P</b>	009-004794-00/009-004795-00 009-004798-00/009-004799-00	C7
			<b>MRA6-90S-I</b> <b>MRA6-90P-I</b>	009-004796-00/009-004797-00 009-004800-00/009-004801-00	
Mortara H12+, X12+		10	<b>H10MT01S-A</b>	9293-017-50	D3
			<b>H10MT01S-I</b>	9293-017-51	
Mortara H3+		5	<b>H05MT02S-A</b>	9293-036-62	D5.1.1
			<b>H05MT02S-I</b>		
Philips Medical PHILIPS ST80i, 453564277261		10	<b>210106S</b> <b>210106P</b>	989803180141/989803180181 989803180121/989803180161	DD1
			<b>210106S-I</b> <b>210106P-I</b>	989803180151/989803180191 989803180131/989803180171	
Philips Medical M2600A, M2601A, M2636A Viridia M2600A		3	<b>AT3-90S</b> <b>AT3-90P</b>	M2590A M2591A	C4
			<b>AT3-90S-I</b> <b>AT3-90P-I</b>	M2594A M2595A	
		5	<b>AT5-90S</b> <b>AT5-90P</b>	M2592A M2593A	C8.1
			<b>AT5-90S-I</b> <b>AT5-90P-I</b>	M2596A M2597A	
Philips Medical MX40 (without SpO2)		3	<b>PT3-90S</b> <b>PT3-90P</b>	989803171801	C4
			<b>PT3-90S-I</b> <b>PT3-90P-I</b>	989803171901	
			<b>PT5-90S</b> <b>PT5-90P</b>	989803171821 989803171831	
		5	<b>PT5-90S-I</b> <b>PT5-90P-I</b>	989803171931	C8.1
			<b>PT6-90S</b> <b>PT6-90P</b>	989803171861	
		<b>PT6-90S-I</b> <b>PT6-90P-I</b>	989803171961		

Compatibility: Manufacturer & Model	Photo	Lead#	Unimed REF#	OEM REF#	Price (unit)
Philips Medical MX40 (with SpO2)		3	<b>PTS3-90S</b> <b>PTS3-90P</b>	989803171811	D1
			<b>PTS3-90S-I</b> <b>PTS3-90P-I</b>	989803171911	
		5	<b>PTS5-90S</b> <b>PTS5-90P</b>	989803171851	D3.4
			<b>PTS5-90S-I</b> <b>PTS5-90P-I</b>	989803171951	
		6	<b>PTS6-90S</b> <b>PTS6-90P</b>	989803171871	D3.5
			<b>PTS6-90S-I</b> <b>PTS6-90P-I</b>	989803171971	
Philips-Braemar ER920W		2	<b>H02HP03S-A</b> (Channel 1, white&red)	350-0173-09	B5
Philips Medical Zymed DigiTrak-Plus DigiTrak XT		5	<b>H05HP02S-A</b>		D3.1
		5	<b>H05HP01S-A</b> <b>H05HP01S-I</b>	989803157481 989803157491/350-0283-03 989803157501	C5
Philips Medical IntelliVue 862108, M2600B, M2601B Viridia, M4840A, M4841A		3	<b>HT3-90S</b> <b>HT3-90P</b>	989803151991 989803173141	C3
			<b>HT3-90S-I</b> <b>HT3-90P-I</b>	989803152001 989803151981	
		5	<b>HT5-90S</b> <b>HT5-90P</b>	989803173151 989803152071	C5
			<b>HT5-90S-I</b> <b>HT5-90P-I</b>	989803152081 989803152061	
Philips Medical combiner shield Telemetry lead sets (U.S. only)		3/5	<b>KW-624-10</b>	M2598A/M2599A	C8 (10pcs/package)
Philips Medical Shower Shield		3	<b>Y05-T119-10</b>	989803153031	C5 (10pcs/package)
		5	<b>Y05-T087-10</b>	989803153041	C6 (10pcs/package)
Philips Medical Alignment Guide		1	<b>Y05-T088-10</b>	989803140401	A3 (10pcs/package)
		2	<b>Y05-T089-10</b>	98980314042	A5 (10pcs/package)



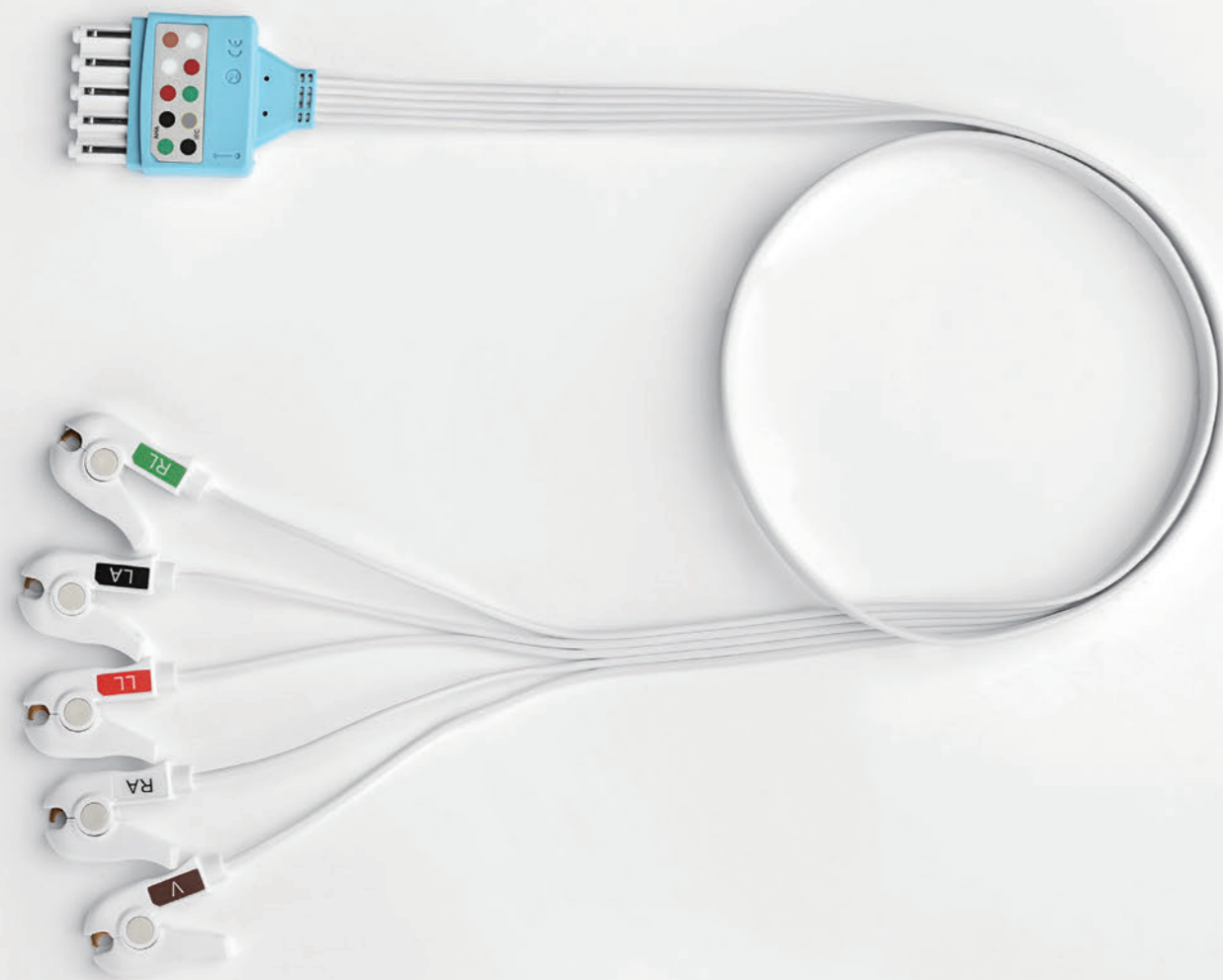

- Full compatibility of the Lead Wires enable to be used with original ECG trunk cables or devices, no extra adapter required.
- Built-in ribbon cable for patient comfort and ease of use
- Easy to read labeling
- Simple connection and lead placement
- Unique light blue color indicated the single use

### 3.1 Disposable ECG Lead Wires

Descriptions	Probe Connector	Lead #	REF# Snap(AHA/IEC)	REF# Grabber(AHA/IEC)	Price (unit)	Package
<b>Din unshielded Individual Set Leads</b>						
Disposable 3-lead no-shielded cable, 90cm		3	D3-90DS D3-90DS-I	D3-90DP D3-90DP-I	B2	10pcs/bag
Disposable 5-lead no-shielded cable, 90cm		5	D5-90DS D5-90DS-I	D5-90DP D5-90DP-I	B5	10pcs/bag
Disposable 3-lead no-shielded cable, with adhesive electrode (white foam), 60cm		3	D3-60D D3-60D-I	N/A N/A	A8	10pcs/bag
Disposable 5-lead no-shielded cable, with adhesive electrode (white foam), 60cm		5	D5-60D D5-60D-I	N/A N/A	B4	10pcs/bag
Disposable 3-lead no-shielded radiotranslucent cable with adhesive electrode, 90cm		3	D3-RT90D D3-RT90D-I	N/A N/A	B3	10pcs/bag
Disposable 5-lead no-shielded radiotranslucent cable with adhesive electrode, 90cm		5	D5-RT90D D5-RT90D-I	N/A N/A	B6	10pcs/bag
<b>Draeger/Dräger &gt; Siemens</b>						
Disposable 3-lead shielded ribbon cable, 90cm		3	DG3-90DS DG3-90DS-I	DG3-90DP DG3-90DP-I	B4	10pcs/bag
Disposable 5-lead shielded ribbon cable, 90cm		5	DG5-90DS DG5-90DS-I	DG5-90DP DG5-90DP-I	B5.3	10pcs/bag
Disposable 6-lead shielded ribbon cable, 90cm		6	DG6-90DS DG6-90DS-I	DG6-90DP DG6-90DP-I	B6.5	10pcs/bag
Disposable 3-lead shielded ribbon cable, 90cm		3	SM3-90DS SM3-90DS-I	SM3-90DP SM3-90DP-I	B4	10pcs/bag
Disposable 3-lead shielded ribbon cable, 90cm		3	SMB3-90DS SMB3-90DS-I	SMB3-90DP SMB3-90DP-I	B3	10pcs/bag
Disposable 5-lead shielded ribbon cable, 90cm		5	SM5-90DS SM5-90DS-I	SM5-90DP SM5-90DP-I	B5.3	10pcs/bag

## 3 Disposable ECG Monitoring Lead Wires



Patient Safety



Patient Comfort





Electrical Performance



Ease of Use

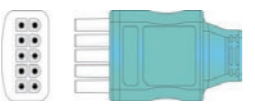



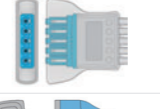
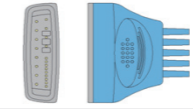

Single patient use (disposable) from patient to monitor, Reduces the risk of cross contamination from reusable cables and lead wires, improving patient care and cost control.

Descriptions	Probe Connector	Lead #	REF# Snap(AHA/IEC)	REF# Grabber(AHA/IEC)	Price (unit)	Package
<b>GE Healthcare</b>						
Disposable 3-lead shielded ribbon cable, 90cm		3	AP3-90DS	AP3-90DP	B7	10pcs/bag
			AP3-90DS-I	AP3-90DP-I		
Disposable 3-lead shielded ribbon cable, 90cm		3	MQ3-90DS	MQ3-90DP	B4	10pcs/bag
			MQ3-90DS-I	MQ3-90DP-I		
Disposable 5-lead shielded ribbon cable, 90cm		5	MQ5-90DS	MQ5-90DP	B5.3	10pcs/bag
			MQ5-90DS-I	MQ5-90DP-I		
Disposable 5-lead shielded ribbon cable, V or C lead ,90cm		5	MV5-90DS	MV5-90DP	B5.3	10pcs/bag
			MV5-90DS-I	MV5-90DP-I		
Disposable 6-lead shielded ribbon cable for Apex, 90cm		6	MQB6-90DS	MQB6-90DP	B6.7	10pcs/bag
			MQB6-90DS-I	MQB6-90DP-I		
<b>Mindray &gt; Datascope</b>						
Disposable 3-lead shielded ribbon cable, 90cm		3	DT3-90DS	DT3-90DP	B4	10pcs/bag
			DT3-90DS-I	DT3-90DP-I		
Disposable 5-lead shielded ribbon cable, 90cm		5	DT5-90DS	DT5-90DP	B5.3	10pcs/bag
			DT5-90DS-I	DT5-90DP-I		
Disposable 3-lead shielded ribbon cable, 90cm		3	MR3-90DS	MR3-90DP	B3	10pcs/bag
			MR3-90DS-I	MR3-90DP-I		
Disposable 5-lead shielded ribbon cable, 90cm		5	MR5-90DS	MR5-90DP	B5	10pcs/bag
			MR5-90DS-I	MR5-90DP-I		
<b>Nihon Kohden</b>						
Disposable 3-lead shielded ribbon cable, 90cm		3	NKB3-90DS	NKB3-90DP	B4	10pcs/bag
			NKB3-90DS-I	NKB3-90DP-I		
Disposable 6-lead shielded ribbon cable, 90cm		6	NKB6-90DS	NKB6-90DP	B6	10pcs/bag
			NKB6-90DS-I	NKB6-90DP-I		
<b>Philips IntelliVue</b>						
Disposable 3-lead shielded ribbon cable, 90cm		3	HP3-90DS	HP3-90DP	B4	10pcs/bag
			HP3-90DS-I	HP3-90DP-I		
Disposable 5-lead shielded ribbon cable, 90cm		5	HPA5-90DS	HPA5-90DP	B5.3	10pcs/bag
			HPA5-90DS-I	HPA5-90DP-I		
Disposable 5-lead shielded ribbon cable, V or C lead ,90cm		5	HPB5-90DS	HPB5-90DP	B5.3	10pcs/bag
			HPB5-90DS-I	HPB5-90DP-I		

Philips IntelliVue Next Page

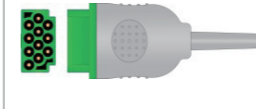
Descriptions	Probe Connector	Lead #	REF# Snap(AHA/IEC)	REF# Grabber(AHA/IEC)	Price (unit)	Package
<b>Philips IntelliVue</b>						
Disposable 3-lead shielded ribbon cable, 90cm		3	HT3-90DS	HT3-90DP	B5	10pcs/bag
			HT3-90DS-I	HT3-90DP-I		
Disposable 5-lead shielded ribbon cable, 90cm		5	HT5-90DS	HT5-90DP	B6.5	10pcs/bag
			HT5-90DS-I	HT5-90DP-I		
Disposable 5-lead shielded ribbon cable, 90cm		5	PT5-90DS	PT5-90DP	C3	10pcs/bag
			PT5-90DS-I	PT5-90DP-I		

### 3.2 Disposable One Piece ECG Lead Wires

OEM & Models	ECG Machine Plug	Lead #	REF# Snap(AHA/IEC)	REF# Grabber(AHA/IEC)	Price (unit)	Package
<b>AAMI</b>						
		3	2340DS	2340DP	B6	10pcs/box
			2340DS-I	2340DP-I		
		5	2540DS	2540DP	B7	10pcs/box
	2540DS-I	2540DP-I				
<b>Philips</b>						
Merlin 78352C/78354C/ 78834CM1001A/		3	2385DS	2385DP	B8.1	10pcs/box
			2385DS-I	2385DP-I		
		5	2585DS	2585DP	C3	10pcs/box
	2585DS-I	2585DP-I				
<b>GE Multi-link</b>						
Eagle,Solar,Dash monitor MAC-Lab Cath Lab Datex-Ohmeda M-Prestn & "E" modules		3	2386DS	2386DP	B6	10pcs/box
			2386DS-I	2386DP-I		
		5	2586DS	2586DP	B8	10pcs/box
	2586DS-I	2586DP-I				
<b>Nihon Kohden</b>						
BSM-2300 lifescopel I BSM-4100 ifescopel P BSM-5100		3	2309DS	2309DP	B6.5	10pcs/box
				2309DS-I		
<b>Mindray / Datascope</b>						
PM5000 PM6000		3	2312DS	2312DP	B6	10pcs/box
				2312DS-I		
Datascope-Mindray V12, V21		3	2326DS	2326DP	B8.1	10pcs/box
				2326DS-I		
		5	2526DS	2526DP	C3	10pcs/box
	2526DS-I	2526DP-I				
<b>Spacelabs</b>						
Ultraview 90492, 91220, 90496, 91496		3	2396DS	2396DP	B8.1	10pcs/box
				2396DS-I		
		5	2596DS	2596DP	C3	10pcs/box
	2596DS-I	2596DP-I				





## 4 ECG Radiolucent Lead Wires

Safety, high performance, accurate measurement

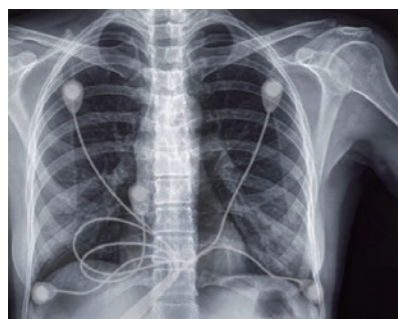

Traditional leadwires



Radiolucent leadwires

Reusable or disposable. Shielded or unshielded. More than 60 radiolucent configurations all from a single source. Radiolucency eliminates the need to replace or reposition ECG leads during fluoroscopy, saving procedure time. Our high-quality solutions enhance productivity, enable standardization, and support outstanding, cost-effective patient care.

### 4.1 Disposable ECG Radiolucent Lead Wires

Descriptions	Photo	Lead #	REF# AHA (Grabber)	REF# IEC (Grabber)	Package	Price (unit)
<b>AAMI DinStyle Radiolucent Lead Wires</b>						
Disposable Radiolucent Lead Wires, Din Type/0.9m	 Figure: D5-90XDP	3	D3-90XDP	D3-90XDP-I	1 set	B1
		5	D5-90XDP	D5-90XDP-I	1set	B4.1
		10	D10-90XDP	D10-90XDP-I	1 set	B7.9
<b>GE Radiolucent Lead Wires</b>						
Disposable Radiolucent Lead Wires,Vs Type/0.9m	 Figure: MQB5-90XDP-I	3	MQB3-90XDP	MQB3-90XDP-I	1 set	B2
		5	MQB5-90XDP	MQB5-90XDP-I	1set	B4.1
		10	MQB10-90XDP	MQB10-90XDP-I	1 set	C1
<b>Philips Radiolucent Lead Wires</b>						
Disposable Radiolucent Lead Wires,AA Type/0.9m	 *To be updated Figure: AAC5-90XDP	3	AAC3-90XDP	AAC3-90XDP-I	1 set	B4
		5	AAC5-90XDP	AAC5-90XDP-I	1set	B6.5
		10	AAC10-90XDP	AAC10-90XDP-I	1 set	C4
<b>Spacelabs Radiolucent Lead Wires</b>						
Disposable Radiolucent Lead Wires,SL Type/0.9m	 Figure: SLB5-90XDP	3	SLB3-90XDP	SLB3-90XDP-I	1 set	B6
		5	SLB5-90XDP	SLB5-90XDP-I	1set	B8.1
		10	SLB10-90XDP	SLB10-90XDP-I	1 set	C4
Disposable Radiolucent Lead Wires,LL Type/0.9m	 Figure: LL5-90XDP-I	3	LL3-90XDP	LL3-90XDP-I	1 set	B3
		5	LL5-90XDP	LL5-90XDP-I	1set	B5
		10	LL10-90XDP	LL10-90XDP-I	1 set	C1
<b>Siemens/Draeger Radiolucent Lead Wires</b>						
Disposable Radiolucent Lead Wires,SM Type/0.9m	 Figure: SME5-90XDP	3	SME3-90XDP	SME3-90XDP-I	1 set	B4
		5	SME5-90XDP	SME5-90XDP-I	1set	B6
		10	SME10-90XDP	SME10-90XDP-I	1 set	C4
Disposable Radiolucent Lead Wires,DG Type/0.9m	 Figure: SMCTA-90XDP-I	5-Limb	SMCTA-90XDP	SMCTA-90XDP-I	1 set	B8.1
		5-Chest	SMCTB-90XDP	SMCTB-90XDP-I	1 set	B8.1

## 4.2 Reusable ECG Radiolucent Lead Wires

Descriptions	Probe Connector	Lead #	REF# AHA (Grabber)	REF# IEC (Grabber)	Package	Price (unit)
<b>GE Radiolucent Lead Wires</b>						
Reusable Radiolucent Lead Wires,VS Type/0.9m	<b>*To be updated</b>  Figure: MQB5-90XP	5	MQ5-90XP	MQ5-90XP-I	1 set	To be updated
		5	MQB5-90XP	MQB5-90XP-I	1set	<b>B7.9</b>
		10	MQB10-90XP	MQB10-90XP-I	1 set	<b>C6.7</b>
<b>AAMI Din Style Radiolucent Lead Wires</b>						
Reusable Radiolucent Lead Wires,Din Type/0.9m	<b>*To be updated</b>  Figure: D5-90XDP	3	D3-90XP	D3-90XP-I	1 set	<b>B4.1</b>
		5	D5-90XP	D5-90XP-I	1set	<b>B6.7</b>
		10	D10-90XP	D10-90XP-I	1 set	<b>C5</b>
<b>IVY Radiolucent Lead Wires</b>						
Reusable Radiolucent Lead Wires,AGT Type/1.2m	<b>*To be updated</b>  Figure: HPD3-90XP	3	HPD3-90XP	HPD3-90XP-I	1 set	<b>C1.3</b>
		4	HPD4-90XP	HPD4-90XP-I	1set	<b>C4</b>
		10	HPD10-90XP	HPD10-90XP-I	1 set	<b>DD1.5</b>
<b>Philips Radiolucent Lead Wires</b>						
Disposable Radiolucent Lead Wires,Din Type/0.9m	<b>*To be updated</b>  Figure: AAC3-90XP	3	AAC3-90XP	AAC3-90XP-I	1 set	<b>B6</b>
		4	AAC4-90XP	AAC4-90XP-I	1 set	<b>B6.7</b>
<b>AAMI Banana Style Radiolucent Lead Wires</b>						
Reusable Radiolucent Lead Wires,Banana Type/0.9m	<b>*To be updated</b>  Figure: B10-90XP	10	B10-90XP	B10-90XP-I	1 set	<b>C8.3</b>



## 5 ECG Lead Adapter and Interface Cable

The unique design of the ECG Lead Wire adapters enable the hospitals to use the one type lead wires to fit major brands patient monitoring system running in one hospital by attaching the proper ECG adapter to the trunk cable. No confusion on Lead Wires any more !

### Specification

<b>Cable material</b>	ABS Jacket, Light gray housing
<b>Connector &amp; Yoke</b>	Nylon plug & Golden plated pins
<b>Link Tie</b>	12cm length with trunk cable clip

### Compatibility

Major brands ECG monitoring leads system



## 5.1 ECG Lead Adapter

OEM Manufacturer	3-Lead REF#	Trunk Cable End	Lead Wire End	Price	5-Lead REF#	Trunk Cable End	Lead Wire End	Price
<b>Convert To Din style Lead Wires</b>								
Colin	AD-CL3-D3			B5	AD-CL5-D5			B6.5
GE Marquette	AD-MQ3-D3			B6	AD-MQ5-D5			B6.7
GE Datex-Ohmeda	AD-DX3-D3			B5	AD-DX5-D5			B6.5
Nihon Kohden	AD-NKA3-D3			B5	AD-NKA5-D5			B6.5
Nihon Kohden	AD-NKB3-D3			B5	N/A	N/A	N/A	N/A
Philips medical	AD-AA3-D3			B5	N/A	N/A	N/A	N/A
Philips medical	AD-HP3-D3			B5	N/A	N/A	N/A	N/A
Siemens/Draeger	AD-SM3-D3			B5	AD-SM5-D5			B6.7
Spacelabs	AD-SL3-D3			B5	AD-SL5-D5			B6.5
<b>Convert To Siemens Lead Wires</b>								
Colin	AD-CL3-SM3			B5	AD-CL5-SM5			B6.5
GE Marquette	AD-MQ3-SM3			B6	AD-MQ5-SM5			B6.7
GE Datex-Ohmeda	AD-DX3-SM3			B5	AD-DX5-SM5			B6.5
Nihon Kohden	AD-NKA3-SM3			B5	AD-NKA5-SM5			B6.5
Nihon Kohden	AD-NKB3-SM3			B5	N/A	N/A	N/A	N/A
Philips medical	AD-AA3-SM3			B5	N/A	N/A	N/A	N/A
Philips medical	AD-HP3-SM3			B5	AD-HP5-SM5			B6.7
Spacelabs	AD-SL3-SM3			B5	AD-SL5-SM5			B6.5
NEC	AD-NECA3-SM3			B5	N/A	N/A	N/A	N/A
NEC	AD-NECB3-SM3			B5	N/A	N/A	N/A	N/A
NEC	AD-NECC3-SM3			B5	N/A	N/A	N/A	N/A

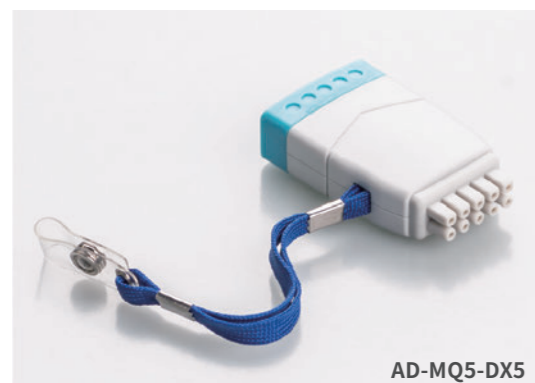

AD-MQ5-DX5

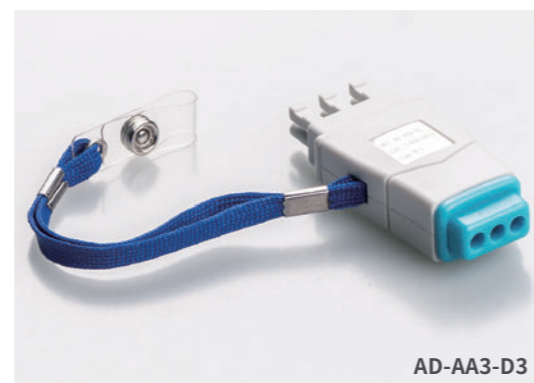

AD-AA3-D3

OEM Manufacturer	3-Lead REF#	Trunk Cable End	Lead Wire End	Price	5-Lead REF#	Trunk Cable End	Lead Wire End	Price
<b>Convert To Philips style Lead Wires</b>								
Colin	AD-CL3-HP3			B5.3	AD-CL5-HP5			B6.6
GE Marquette	AD-MQ3-HP3			B5.3	AD-MQ5-HP5			B6.6
GE Datex-Ohmeda	AD-DX3-HP3			B5	AD-DX5-HP5			B6.5
Nihon Kohden	AD-NKA3-HP3			B5.3	AD-NKA5-HP5			B6.6
Nihon Kohden	AD-NKB3-HP3			B5.3	N/A	N/A	N/A	N/A
Philips medical	AD-AA3-HP3			B5	N/A	N/A	N/A	N/A
Siemens/Draeger	AD-SM3-HP3			B5	AD-SM5-HP5			B6.7
Spacelabs	AD-SL3-HP3			B5	AD-SL5-HP5			B6.5
NEC	AD-NECA3-HP3			B5	N/A	N/A	N/A	N/A
NEC	AD-NECB3-HP3			B5	N/A	N/A	N/A	N/A
NEC	AD-NECC3-HP3			B5	N/A	N/A	N/A	N/A
<b>Convert To GE Multi-link Lead Wires</b>								
Colin	N/A	N/A	N/A	N/A	AD-CL5-MQ5			B6.5
GE Datex-Ohmeda	N/A	N/A	N/A	N/A	AD-DX5-MQ5			B6.5
Nihon Kohden	N/A	N/A	N/A	N/A	AD-NKA5-MQ5			B6.5
Siemens/Draeger	N/A	N/A	N/A	N/A	AD-SM5-MQ5			B6.7
Spacelabs	N/A	N/A	N/A	N/A	AD-SL5-MQ5			B6.5
Philips medical	N/A	N/A	N/A	N/A	AD-HP5-MQ5			B6.6
<b>Convert To Datex Lead Wires</b>								
Colin	AD-CL3-DX3			B5	AD-CL5-DX5			B6.5
GE Marquette	AD-MQ3-DX3			B6	AD-MQ5-DX5			B6.7
Nihon Kohden	AD-NKA3-DX3			B5	AD-NKA5-DX5			B6.5
Nihon Kohden	AD-NKB3-DX3			B5	N/A	N/A	N/A	N/A
Philips medical	AD-AA3-DX3			B5	N/A	N/A	N/A	N/A
Philips medical	AD-HP3-DX3			B5	AD-HP5-DX5			B6.6
Siemens/Draeger	AD-SM3-DX3			B5	AD-SM5-DX5			B6.7
Spacelabs	AD-SL3-DX3			B5	AD-SL5-DX5			B6.5



OEM Manufacturer	3-lead REF#	Trunk Cable End	Lead wire End	Price	5-lead REF#	Trunk Cable End	Lead wire End	Price
Convert to Spacelabs Style Lead Wires								
Colin	AD-CL3-SL3			B5	AD-CL5-SL5			B6.5
GE Marquette	AD-MQ3-SL3			B5	AD-MQ5-SL5			B6.5
GE Datex-Ohmeda	AD-DX3-SL3			B5	AD-DX5-SL5			B6.5
Nihon Kohden	AD-NKA3-SL3			B5	AD-NKA5-SL5			B6.5
Nihon Kohden	AD-NKB3-SL3			B5	N/A	N/A	N/A	N/A
Philips medical	AD-AA3-SL3			B5	N/A	N/A	N/A	N/A
Philips medical	AD-HP3-SL3			B5	N/A	N/A	N/A	N/A
Siemens/Draeger	AD-SM3-SL3			B5	AD-SM5-SL5			B6.7

## 5.2 ECG Lead Interface Cable

OEM Manufacturer	REF#	Trunk Cable End	Lead Wire End	Price	REF#	Trunk Cable End	Lead wire End	Price
Draeger Interface Cable(Convert To Draeger Single-pin lead wires )								
Draeger	AD-DG6M-DG6F (MS16256)			C3	AD-DG5M-SM5F			C3
Draeger	AD-DG6M-D3F (MS25951)			C2				
Siemens Interface Cable(Convert To Siemens dual-pin lead wires)								
Siemens	AD-SM5M-DG5F			C4	AD-SM5M-SM5F (MS16492)			C4



## ⑥ Diagnosis EKG Cables & Accessories

### Specification

Cable material	TPU Jacket, Light gray
Connector & Yoke	Nylon plug & Golden plated pins
Trunk cable length	2.2m
Lead wires length	1.2m(limb lead), 0.8m(Chest lead)

### Compatibility

Major brands EKG diagnosis system

☆ The upgrade type of Direct-connect EKG Cable is available for choice(see the photo show as above), the model no. named as original model plus " Z". eg. the original model is E10-HP-B, the upgraded model no.is E10-HP-B-Z.



# Application Diagram

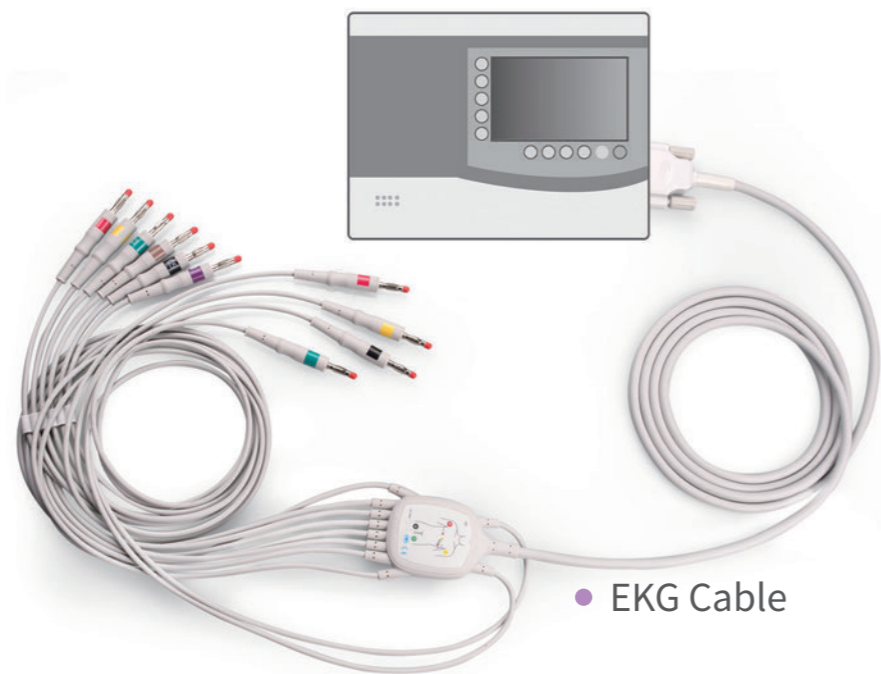

● EKG Cable

Product Name	Photo	REF# Example	Reference to REF# Descriptions
One Piece Fixed Cable		E10R-HP-B/I	E: EKG diagnostic cable or lead wire 10: 10-lead(12=12-lead) R: Built in resistors for protection(default: no resistors) HP: Philips model code B: banana end(N= needle, P=grabber, S=snap) I: IEC code (default is AHA code)
Trunk Cable		E10R-MQ-I	E: EKG diagnostic cable or lead wire 10: 10-lead(12=12 lead) R: Built in resistors for protection(default: no resistors) MQ: GE marquette model code I: IEC code (default is AHA code)
Lead Wire		MQ10-LB-I	MQ: Marquette, factory/model code 10: 10-lead(12=12 lead) L: Lead wires B: Banana end(N= needle, P=grabber, S=snap) I: IEC code (default is AHA code)
One Piece Fixed Cable		E10-HP-B-Z	E: EKG diagnostic cable or lead wire 10: 10-lead(12=12-lead) R: built in resistors for protection(default: no resistors) HP: Philips model code B: banana end(N= needle, P=grabber, S=snap) I: IEC code (Default is AHA code) Z: Molding yoke type

All one piece cable or lead wires are available with banana end, needle end, grabber end and snap end

Code	AHA(A)	Standard IEC(I)	Alternate IEC(IH)
4mm Banana end (B)			
3mm Needle end (N)			
Grabber End (P)			
Snap End (S)			

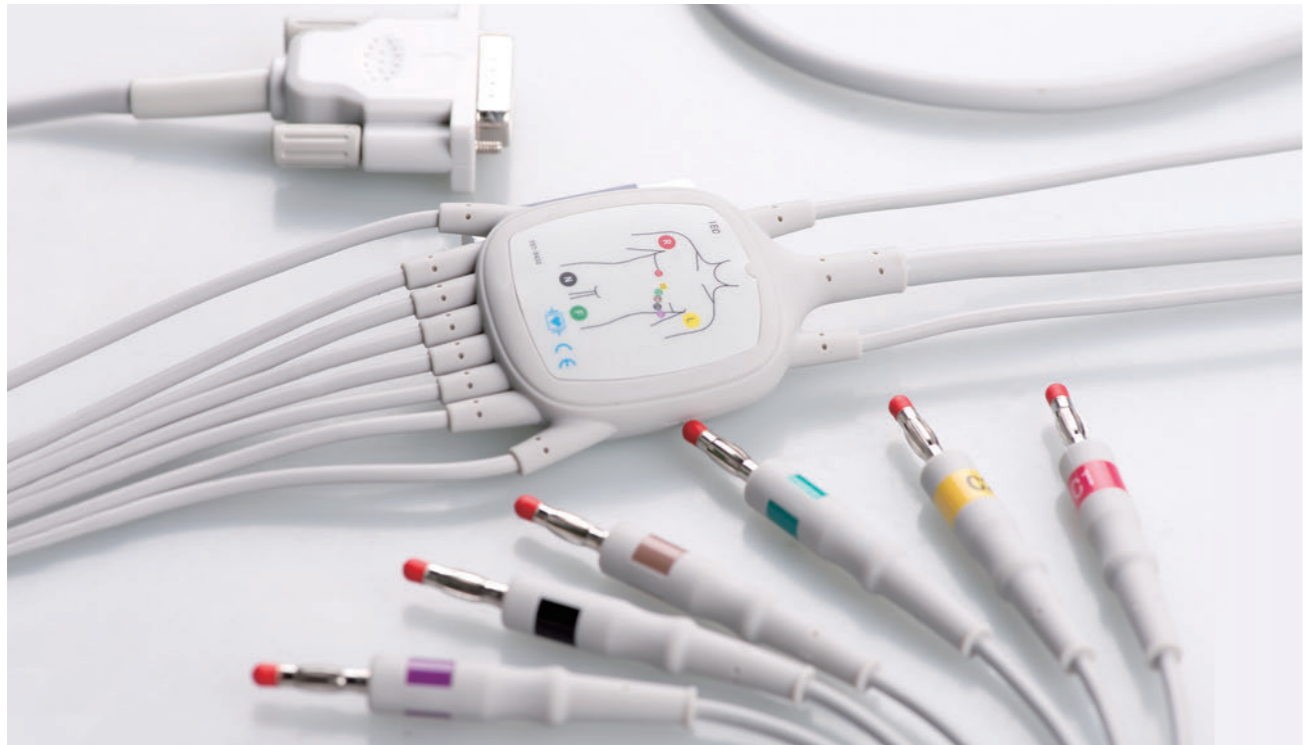

# 6.1 One Piece EKG Fixed Cable



OEM & Models	EKG Machine Plug	Lead#	with 4mm Banana	with 3mm Needle	with Grabber End	with Snap End	Price (set)
<b>Carewell</b>							
1101, 1103, 1103B, AR 1200ADV, ECG-1103LW, 1101G, T12		10	E10-CW-B	E10-CW-N	E10-CW-P	E10-CW-S	DD1
		10	E10-CW-B/I	E10-CW-N/I	E10-CW-P/I	E10-CW-S/I	
<b>Edan</b>							
SE-1010PC, SE-12, SE-12 Express, SE-1200, SE-3, SE-601A, SE-601B, SE-601C, ST-1212		10	E10-ED-B	E10-ED-N	E10-ED-P	E10-ED-S	D3
		10	E10R-ED-B	E10R-ED-N	E10R-ED-P	E10R-ED-S	DD1
<b>Fukuda Denshi</b>							
CardiMax FX-7202, CardiMax FX-7402, CardiMax FX-7101, CardiMax FX-7102, FCP 2155, FCP 2201, FCP 4101, FCP 4101A, FX-101, FX-102F, FX-3010, FX-328UY		10	E10-FD1-B	E10-FD1-N	E10-FD1-P	E10-FD1-S	D3
		10	E10R-FD1-B	E10R-FD1-N	E10R-FD1-P	E10R-FD1-S	DD1
<b>Fukuda ME</b>							
Cardisunny, KP-500, KP-500D		10	E10-FD2-B	E10-FD2-N	E10-FD2-P	E10-FD2-S	D3
		10	E10R-FD2-B	E10R-FD2-N	E10R-FD2-P	E10R-FD2-S	DD1
<b>GE Healthcare &gt; Marquette</b>							
MAC 1000, MAC 1100, MAC 1200, MAC 1600, MAC 2000, MAC 3500, MAC 400, MAC 500, MAC 600, MAC 800, Microsmart M		10	E10-MQ-B	E10-MQ-N	E10-MQ-P	E10-MQ-S	D3
		10	E10R-MQ-B	E10R-MQ-N	E10R-MQ-P	E10R-MQ-S	DD1



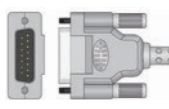
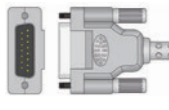

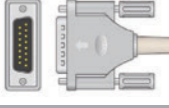



OEM & Models	EKG Machine Plug	Lead#	with 4mm Banana	with 3mm Needle	with Grabber End	with Snap End	Price (set)
<b>Hellige / Siemens Hörmann / Bosch</b>							
Hellige: Cardiosys, EK36, EK403, EK41, EK413, EK43, EK52, EK53 Siemens Hörmann: Cardiotat 1 / 3 T / 703 / 710, Cardina C, Cardivex 31/4/6/7/62, Cathcor, Megacard Elmarc/RS/RE Bosch: Bioset 3500/3600/3700/5000/8000		10	E10-HL-B	E10-HL-N	E10-HL-P	E10-HL-S	D3
		10	E10R-HL-B	E10R-HL-N	E10R-HL-P	E10R-HL-S	DD1
<b>Kenz</b>							
103, 106, 107, 1201, 302, 303		10	E10-KZ1-B	E10-KZ1-N	E10-KZ1-P	E10-KZ1-S	D3
		10	E10R-KZ1-B	E10R-KZ1-N	E10R-KZ1-P	E10R-KZ1-S	DD1
108, 109, 110, 1210, 1211, 601, Cardico 302		10	E10R-KZ2-B	E10R-KZ-N	E10R-KZ2-P	E10-RKZ2-S	DD1
		10	E10R-KZ2-B/I	E10R-KZ2-N/I	E10R-KZ2-P/I	E10R-KZ2-S/I	
<b>Mortara &gt; Burdick</b>							
E350, E350I, E550, E560, EK10, Eclipse LE, Elite, Elite II		10	E10-BK1-B	E10-BK1-N	E10-BK1-P	E10-BK1-S	D3
		10	E10R-BK1-B	E10R-BK1-N	E10R-BK1-P	E10R-BK1-S	DD1
1600, 300, 3100, 400, 6100, 800, 8300, 850, 8500, Atria 3000, Eclipse LE II, Eclipse 4, Plus, Premier, Eclipse Plus		10	E10-BK2-B	E10-BK2-N	E10-BK2-P	E10-BK2-S	D3
		10	E10R-BK2-B	E10R-BK2-N	E10R-BK2-P	E10R-BK2-S	DD1
ELI 10, ELI 100, ELI 200, ELI 50, Landscape, Portrait, Xscribe DOS		10	E10-MT-B	E10-MT-N	E10-MT-P	E10-MT-S	D3
		10	E10R-MT-B	E10R-MT-N	E10R-MT-P	E10R-MT-S	DD1
<b>Mortara&gt;Quinton</b>							
Q-Stress		10	E10R-BK3-B	E10R-BK3-N	E10R-BK3-P	E10R-BK3-S	DD1
Q-4000, Q-4500, Q750		10	E10-QT-B	E10-QT-N	E10-QT-P	E10-QT-S	D4.4
<b>Nihon Kohden</b>							
5151A, 5403A, 5503A, 5504A, 6151, 6151A, 6151B, 6306A, 6353, 6353A, 6543A, 6851, 8110, 8330, 8330A, Cardiocap, Escape 12		10	E10-NK1-B	E10-NK1-N	E10-NK1-P	E10-NK1-S	D3
		10	E10R-NK1-B	E10R-NK1-N	E10R-NK1-P	E10R-NK1-S	DD1
Cardiocap C, Cardiocap GEM 9020K, Cardiocap M, Cardiocap Q, Cardiocap S, ECG-1150, ECG-1250, ECG-1250A, ECG-1250K, ECG-1360, ECG-1250A, ECG-1350K, ECG-2150, ECG-2250, ECG-2350, ECG-9010, ECG-9010K, ECG-9020, ECG-9020K, ECG-9022, ECG-9110, ECG-9110K, ECG-9130, ECG-9130K, ECG-9132, ECG-9620, ECG-9620L		10	E10-NK2-B	E10-NK2-N	E10-NK2-P	E10-NK2-S	D3
		10	E10R-NK2-B	E10R-NK2-N	E10R-NK2-P	E10R-NK2-S	DD1
<b>Philips</b>							
200, 200i, Agilent 300Pi, Agilent 300i, M1770A, M1771A, M1772A, Pagewriter 100, Pagewriter 200, Pagewriter 300pi		10	E10-HP-B	E10-HP-N	E10-HP-P	E10-HP-S	D3
		10	E10R-HP-B	E10R-HP-N	E10R-HP-P	E10R-HP-S	DD1
Pagewrite TC10		10	E10R-HPT1-B	E10R-HPT1-N	E10R-HPT1-P	E10R-HPT1-S	DD1
Pagewrite TC20		10	E10R-HPT2-B	E10R-HPT2-N	E10R-HPT2-P	E10R-HPT2-S	DD1

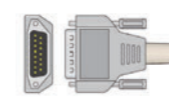
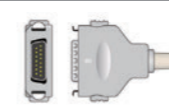
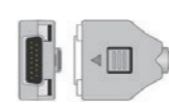

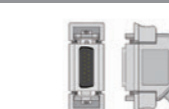
OEM & Models	EKG Machine Plug	Lead#	with 4mm Banana	with 3mm Needle	with Grabber End	with Snap End	Price (set)
<b>Schiller</b>							
AT1, AT2, AT2 Light, AT2 Plus, AT4, AT10, AT10 Plus, AT101, AT102, AT102-Plus, AT104, AT110, AT3, AT5, AT6, AT60, C6, CS6		10	E10-SH1-B E10-SH1-B/I	E10-SH1-N E10-SH1-N/I	E10-SH1-P E10-SH1-P/I	E10-SH1-S E10-SH1-S/I	D3
		10	E10R-SH1-B E10R-SH1-B/I	E10R-SH1-N E10R-SH1-N/I	E10R-SH1-P E10R-SH1-P/I	E10R-SH1-S E10R-SH1-S/I	DD1
AT10, AT10 Plus, AT101, AT102, AT102-Plus, AT104, AT110, AT3, AT5, AT6, AT60, C6, CS6, MS2010, MS2015		10	E10-SH2-B E10-SH2-B/I	E10-SH2-N E10-SH2-N/I	E10-SH2-P E10-SH2-P/I	E10-SH2-S E10-SH2-S/I	D3
		10	E10R-SH2-B E10R-SH2-B/I	E10R-SH2-N E10R-SH2-N/I	E10R-SH2-P E10R-SH2-P/I	E10R-SH2-S E10R-SH2-S/I	DD1
<b>Welch Allyn</b>							
SE-PRO-600		10	E10R/055-WA-B <small>(RE-PC-AHA-BAN)</small>	E10R/055-WA-N	E10R/055-WA-P	E10R/055-WA-S	D4.4
		10	E10R/055-WA-B/I <small>(RE-PC-IEC-BAN)</small>	E10R/055-WA-N/I	E10R/055-WA-P/I	E10R/055-WA-S/I	
CP 10, CP 150, CP 20, CP 250, CP 50		10	E10-HP-B E10-HP-B/I	E10-HP-N E10-HP-N/I	E10-HP-P E10-HP-P/I	E10-HP-S E10-HP-S/I	D3
		10	E10R-HP-B E10R-HP-B/I	E10R-HP-N E10R-HP-N/I	E10R-HP-P E10R-HP-P/I	E10R-HP-S E10R-HP-S/I	DD1

## 6.2 EKG Trunk Cable



OEM & Models	EKG Machine Plug	Lead#	REF#	Used with lead wire set/GE Multi-link set	Price (set)
<b>Edan</b>					
SE-1010PC, SE-12, SE-12 Express, SE-1200, SE-3, SE-601A, SE-601B, SE-601C, ST-1212		10	<b>E10-ED</b> <b>E10-ED-I</b>	10-lead, chest /0.9m;Limb/1.2m MQ10-LB, MQ10-LN, MQ10-LP, MQ10-LS or MQB10-LB,...	C6
		10	<b>E10R-ED</b> <b>E10R-ED-I</b>	10-lead, chest /0.9m;Limb/1.2m MQ10-LB-I, MQ10-LN-I, MQ10-LP-I, MQ10-LS-I or MQB10-LB-I, ... <small>(See the next page of 10-lead wire sets for detail)</small>	D1
<b>Fukuda Denshi</b>					
CardiMax FX-7202, CardiMax FX-7402, CardiMax FX-7101, CardiMax FX-7102, FCP 2155, FCP 2201, FCP 4101, FCP 4101A, FX-101, FX-102F, FX-3010, FX-328UY		10	<b>E10-FD1</b> <b>E10-FD1-I</b>	Same as above	C6
		10	<b>E10R-FD1</b> <b>E10R-FD1-I</b>	Same as above	D1
<b>Fukuda ME</b>					
Cardisuny, KP-500, KP-500D		10	<b>E10-FD2</b> <b>E10-FD2-I</b>	Same as above	C6
		10	<b>E10R-FD2</b> <b>E10R-FD2-I</b>	Same as above	D1
<b>GE Healthcare &gt; Marquette</b>					
MAC 1000, MAC 1100, MAC 1200, MAC 1600, MAC 2000, MAC 3500, MAC 400, MAC 500, MAC 600, MAC 800, Microsmart M		10	<b>E10-MQ</b> <b>E10-MQ-I</b>	Same as above	C6
		10	<b>E10R-MQ</b> <b>E10R-MQ-I</b>	Same as above	D1
<b>Hellige / Siemens Hormann / Bosch</b>					
Hellige: Cardiosys, EK36, EK403, EK41, EK413, EK43, EK512, EK53 Siemens Hormann: Cardiosat L 3 / 7 / 703 / 710, Cardina C, Cardinea 3TH, 6T/162, Cathcor, Megacard/ElemA/B/R/E Bosch: Bioset 3500/3600/3700/5000/8000		10	<b>E10-HL</b> <b>E10R-HL</b>	Same as above	C6
		10	<b>E10R-HL</b> <b>E10R-HL-I</b>	Same as above	D1
<b>Kenz</b>					
103, 106, 107, 1201, 302, 303		10	<b>E10-KZ1</b> <b>E10-KZ1-I</b>	Same as above	C6
		10	<b>E10R-KZ1</b> <b>E10R-KZ1-I</b>	Same as above	D1
108, 109, 110, 1210, 1211, 601,		10	<b>E10R-KZ2</b> <b>E10R-KZ2-I</b>	Same as above	D1
<b>Miortara &gt; Burdick</b>					
E350, E350I, E550, E560, EK10, Eclipse LE, Elite, Elite II		10	<b>E10-BK1</b> <b>E10-BK1-I</b>	Same as above	C6
		10	<b>E10R-BK1</b> <b>E10R-BK1-I</b>	Same as above	D1
1600, 300, 3100, 400, 6100, 800, 8300, 850, 8500, Atria 3000, Eclipse LE II, Eclipse 4, Plus, Premier, Eclipse Plus		10	<b>E10-BK2</b> <b>E10-BK2-I</b>	Same as above	C6
		10	<b>E10R-BK2</b> <b>E10R-BK2-I</b>	Same as above	D1
ELI 10, ELI 100, ELI 200, ELI 50, Landscape, Portrait, XScribe DOS		10	<b>E10-MT</b> <b>E10-MT-I</b>	Same as above	C6
		10	<b>E10R-MT</b> <b>E10R-MT-I</b>	Same as above	D1
<b>Nihon Kohden</b>					
5151A, 5403A, 5503A, 5504A, 6151, 6151A, 6151B, 6306A, 6353, 6353A, 6543A, 6851, 8110, 8330, 8330A, Cardiocap, Escape 12		10	<b>E10-NK1</b> <b>E10-NK1-I</b>	Same as above	C6
		10	<b>E10R-NK1</b> <b>E10R-NK1-I</b>	Same as above	D1

OEM& Models	EKG Machine Plug	Lead#	REF#	Used with lead wire set/GE Multi-link set	Price (set)
<b>Nihon Kohden</b>					
Cardiacap C, Cardiacap GEM 9020K, Cardiacap M, Cardiacap Q, Cardiacap S, ECG-1150, ECG-1250, ECG-1250A, ECG-1250B, ECG-1350, ECG-1350A, ECG-1350B, ECG-2150, ECG-2250, ECG-2350, ECG-9010, ECG-9010K, ECG-9020, ECG-9020K, ECG-9022, ECG-9110, ECG-9110K, ECG-9130, ECG-9130K, ECG-9132, ECG-9620, ECG-9620L		10	<b>E10-NK2</b> <b>E10-NK2-I</b>	Same as above	C6
		10	<b>E10R-NK2</b> <b>E10R-NK2-I</b>	Same as above	D1
<b>Philips</b>					
200, 200i, Agilent 300PI, Agilent 300i, M1770A, M1771A, M1772A, Pagewriter 100, Pagewriter 200, Pagewriter 300pi		10	<b>E10-HP</b> <b>E10-HP-I</b>	Same as above	C6
		10	<b>E10R-HP</b> <b>E10R-HP-I</b>	Same as above	D1
<b>Schiller</b>					
AT1, AT2, AT2 Light, AT2 Plus, AT4, AT10, AT10 Plus, AT101, AT102, AT102-Plus, AT104, AT110, AT3, AT5, AT6, AT60, C6, CS6		10	<b>E10-SH1</b> <b>E10-SH1-I</b>	Same as above	C6
		10	<b>E10R-SH1</b> <b>E10R-SH1-I</b>	Same as above	D1
<b>GE Healthcare-Resting sys.</b>					
CAM 14, CASE, MAC 5000, MAC 5500		/	<b>ECAM-GE14</b> (2016560-002/2016560-003) 4.5m+0.65m	Used with CAM 14 patient lead wires on next page.	D5.3
			<b>ECAM-GE14-S</b> (2016560-001) 1.4m+0.3m		D5.2
CASE 12, CASE 15, MAC PC, MAC 6, MAC 12, MAC 15, CENTRA Systems with AM4 or AM5 Acquisition Module		/	<b>EAM-GE4</b> (700044-202) 4.6m+0.25m	Used with CAM 4 patient lead wires on next page.	D5.3
			<b>EAM-GE4-S</b> (700044-203) 1.3m+0.25m		D5.2
AM4, AM5, MAX-1, MAX-4, MAX-6		/	<b>EMAX1-GE4</b> (700044-201) 4.6m+0.25m	Used with CAM 14 patient lead wires on next page.	D6
AM4, AM5, CASE 16, MAC VU, MAX-Personal		/	<b>EAM-EAM-GE4</b> (700044-204) 4.6m	Used with CAM 4 patient lead wires on next page.	D6.4
			<b>EAM-EAM-GE4-S</b> (700044-205) 1.3m		D5.3
<b>Philips PageWriter</b>					
TC30/TC50/TC70 (with a Class B PIM)		/	<b>OT-040</b> (989803164281) 2.0m	Used with PageWriter lead wires on next page.	D4
TC70 (with a Class A PIM)		/	<b>OT-055</b> (989803158481) 2.0m	Used with PageWriter lead wires on next page.	D4













Figure: EAM-GE4



Figure: OT-040

### 6.3 EKG Lead Wire

Pictures	OEM & Models	Electrode end	REF# (AHA)	REF# (IEC)	Lead	Price (set)
<b>GE Multi-Link 10-lead-integrated Leads</b>						
	MAC 1000, MAC 1100, MAC 1200, MAC 1600, MAC 2000, MAC 3500, MAC 400, MAC 500, MAC 600, MAC 800, Microsmart M	4mm banana	<b>MQ10-LB</b> (900112-001/38401818)	<b>MQ10-LB-I</b> (900112-002/38401817)	10	D1
		3mm needle	<b>MQ10-LN</b>	<b>MQ10-LN-I</b>	10	D1
		Grabber	<b>MQ10-LP</b>	<b>MQ10-LP-I</b>	10	D1
		Snap	<b>MQ10-LS</b>	<b>MQ10-LS-I</b>	10	D1
<b>GE CAM 14 Patient Lead Wires</b>						
	CAM 14, CASE 8000, CASE P2, MAC 1000, MAC 1100, MAC 1200, MAC 1600, MAC 2000, MAC 3500, MAC 400, MAC 500, MAC 5000, MAC 5000ST, MAC 5500, MAC 600, MAC 800, Microsmart M	4mm banana	<b>MQB10-LB</b>	<b>MQB10-LB-I</b>	10	D1
		3mm needle	<b>MQB10-LN</b>	<b>MQB10-LN-I</b>	10	D1
		Grabber	<b>MQB10-LP</b>	<b>MQB10-LP-I</b>	10	D1
		Snap	<b>MQB10-LS</b>	<b>MQB10-LS-I</b>	10	D1
	420101-002(10-Lead) 420101-001(14-Lead) Used with Unimed Adapter as electrodes end (see below)	CAM/Universal	<b>MQB10-AD</b>	<b>MQB10-AD-I</b>	10	D3.2
		CAM/Universal	<b>MQB14-AD</b>	<b>MQB14-AD-I</b>	14	D4.4
	2001925-001(51cm) 2001925-002(74cm) 2001925-006(90cm)	CAM/Universal	<b>X-MQB-90DF-10</b> (90cm, no color coded)		10	D3.5
	2001925-003(102cm) 2001925-004(130cm)	CAM/Universal	<b>X-MQB-120DF-10</b> (120cm, no color coded)		10	DD1
<b>GE AM4/AM5 Patient Lead Wires</b>						
	AM4, AM5, CASE 12, CASE 15, CASE 16, CENTRA, MAC 12, MAC 15, MAC 6, MAC 8, MAC PC, MAC VU, MAX-1, MAX-Personal	4mm banana	<b>MQD10-LB</b>	<b>MQD10-LB-I</b>	10	D2
		3mm needle	<b>MQD10-LN</b>	<b>MQD10-LN-I</b>	10	D2
		Grabber	<b>MQD10-LP</b>	<b>MQD10-LP-I</b>	10	D2
		Snap	<b>MQD10-LS</b>	<b>MQD10-LS-I</b>	10	D2
	900177-001(12-Lead) Used with Unimed Adapter as electrodes end (see below)	CAM/Universal	<b>MQD12-AD</b>	<b>MQD12-AD-I</b>	12	D4
	406581-001(46cm) 406581-002(60cm) 406581-003(66cm) 406581-004(90cm)	CAM/Universal	<b>X-MQD-90DF-10</b> (90cm, no color coded)		10	D3.5
	406581-005(107cm) 406581-006(132cm)	CAM/Universal	<b>X-MQD-120DF-10</b> (120cm, no color coded)		10	DD1
<b>GE CAM14/AM4/AM5 Electrode Adapter</b>						
	Change CAM 14 and AM4/AM5 universal leadwires to use with variety of electrodes	4mm banana, 10 pcs/set	<b>AD10-DB</b> (900178-001)	<b>AD10-DB-I</b> (900178-101)	10	B7.9
		4mm banana, 12 pcs/set	<b>AD12-DB</b>	<b>AD12-DB-I</b>	12	C1.3
		4mm banana, 14 pcs/set	<b>AD14-DB</b> (900179-201)	<b>AD14-DB-I</b> (900178-201)	14	C3
	Change CAM 14 and AM4/AM5 universal leadwires to use with variety of electrodes	Grabber, 10 pcs/set	<b>AD10-DP</b> (900178-003)	<b>AD10-DP-I</b> (900178-103)	10	C6
		Grabber, 12 pcs/set	<b>AD12-DP</b>	<b>AD12-DP-I</b>	12	C7
		Grabber, 14 pcs/set	<b>AD14-DP</b> (900179-203)	<b>AD14-DP-I</b> (900178-203)	14	C8.3
	Change CAM 14 and AM4/AM5 universal leadwires to use with variety of electrodes	Snap, 10 pcs/set	<b>AD10-DS</b>	<b>AD10-DS-I</b>	10	C6
		Snap, 12 pcs/set	<b>AD12-DS</b>	<b>AD12-DS-I</b>	12	C7
		Snap, 14 pcs/set	<b>AD14-DS</b>	<b>AD14-DS-I</b>	14	C8.3



Pictures	OEM & Models	Electrode end	REF# (AHA)	REF# (IEC)	Pieces/Set	Price (set)
<b>GE CAM14/AM4/AM5 Electrode Adapter</b>						
	Change CAM 14 and AM4/AM5 universal leadwires to use with variety of electrodes	Wide mouth, 10 pcs/set	<b>AD10-DW</b>	<b>AD10-DW-I</b>	10	C4
		Wide mouth, 12 pcs/set	<b>AD12-DW</b>	<b>AD12-DW-I</b>	12	C6
		Wide mouth, 14 pcs/set	<b>AD14-DW</b>	<b>AD14-DW-I</b>	14	C8.1
	Change CAM 14 and AM4/AM5 universal leadwires to use with variety of electrodes	Alligator clip, 10 pcs/set	<b>AD10-DA</b> <small>(900178-002)</small>	<b>AD10-DA-I</b> <small>(900178-102)</small>	10	C6.7
		Alligator clip, 12 pcs/set	<b>AD12-DA</b>	<b>AD12-DA-I</b>	12	C8.3
		Alligator clip, 14 pcs/set	<b>AD14-DA</b> <small>(900179-202)</small>	<b>AD14-DA-I</b> <small>(900178-202)</small>	14	D1
<b>Philips Lead Wires</b>						
	PageWriter Touch: 860284, PageWriter Trim Cardiographs, 860286, 860288, 860290	4mm banana	<b>PW10-LB</b> <small>(989803129161)</small>	<b>PW10-LB-I</b> <small>(989803129191)</small>	10	D3
		3mm needle	<b>PW10-LN</b>	<b>PW10-LN-I</b>	10	D3
		Grabber	<b>PW10-LP</b>	<b>PW10-LP-I</b>	10	D3
		Snap	<b>PW10-LS</b>	<b>PW10-LS-I</b>	10	D3
	PageWriter TC70: 860315; PageWriter TC30: 860306; PageWriter TC50: 860310	4mm banana	<b>PWC10-LB</b> <small>(989803151631)</small>	<b>PWC10-LB-I</b> <small>(989803151641)</small>	10	D1
		3mm needle	<b>PWC10-LN</b>	<b>PWC10-LN-I</b>	10	D1
		Grabber	<b>PWC10-LP</b>	<b>PWC10-LP-I</b>	10	D1
		Snap	<b>PWC10-LS</b>	<b>PWC10-LS-I</b>	10	D1
<b>QUINTON Lead Wires</b>						
	Q-710 Stress Test System	4mm banana	<b>QT10-LB</b>	<b>QT10-LB-I</b>	10	D3.4
		3mm needle	<b>QT10-LN</b>	<b>QT10-LN-I</b>	10	D3.4
		Grabber	<b>QT10-LP</b> <small>(031257-002)</small>	<b>QT10-LP-I</b>	10	D3.4
		Snap	<b>QT10-LS</b>	<b>QT10-LS-I</b>	10	D3.4
<b>Midmark Lead wire</b>						
	IQ, IQecg	4mm banana	<b>MI10-LB</b> <small>(3-100-0203)</small>	<b>MI10-LB-I</b>	10	D3.2
		3mm needle	<b>MI10-LN</b>	<b>MI10-LN-I</b>	10	D3.2
		Grabber	<b>MI10-LP</b>	<b>MI10-LP-I</b>	10	D3.2
		Snap	<b>MI10-LS</b>	<b>MI10-LS-I</b>	10	D3.2
<b>Mortara Lead Wires</b>						
	ELI 150C, ELI 230, ELI 250C, ELI 280, ELI 350 (defibrillation-proof)	4mm banana	<b>MT10-LB</b> <small>(9293-046-60)</small>	<b>MT10-LB-I</b>	10	D2
		3mm needle	<b>MT10-LN</b>	<b>MT10-LN-I</b>	10	D2
		Grabber	<b>MT10-LP</b>	<b>MT10-LP-I</b>	10	D2
		Snap	<b>MT10-LS</b>	<b>MT10-LS-I</b>	10	D2
<b>Norav (AA style) Lead Wires</b>						
		4mm banana	<b>AA10-LB</b>	<b>AA10-LB-I</b>	10	D1
		3mm needle	<b>AA10-LN</b>	<b>AA10-LN-I</b>	10	D1
		Grabber	<b>AA10-LP</b>	<b>AA10-LP-I</b>	10	D1
		Snap	<b>AA10-LS</b>	<b>AA10-LS-I</b>	10	D1
<b>Welch Allyn Lead Wires</b>						
	CP100/CP200	4mm banana	<b>WA10-LB</b> <small>(401129)</small>	<b>WA10-LB-I</b> <small>(401122)</small>	10	D1
		3mm needle	<b>WA10-LN</b>	<b>WA10-LN-I</b>	10	D1
		Grabber	<b>WA10-LP</b> <small>(401123)</small>	<b>WA10-LP-I</b> <small>(401124)</small>	10	D1
		Snap	<b>WA10-LS</b>	<b>WA10-LS-I</b>	10	D1

## 6.4 EKG Accessories



ECG Electrodes	REF#	Package	Price (box)	REF to Figures
Adult limb clamps/IEC, universal	<b>UU-LC-A</b>	4 pcs/box	<b>B6.6</b>	A
Adult limb clamps/AHA, all clamps in green	<b>UU-LC-AA</b>	4 pcs/box	<b>B6.5</b>	E
Pediatric limb clamps/IEC, universal	<b>UU-LC-P</b>	4 pcs/box	<b>B6.5</b>	B
Pediatric limb clamps/AHA, all clamps in green	<b>UU-LC-PA</b>	4 pcs/box	<b>B6.5</b>	E
Adult limb clamps, for snap electrode, 3-lead	<b>UU-DLC-A</b>	2 pcs/box	B6	F
Adult suction electrodes, universal	<b>UU-SE-A</b>	6 pcs/box	B7.9	C
Pediatric suction electrodes, universal	<b>UU-SE-P</b>	6 pcs/box	C1	D
Adult blue bulb	<b>Y05-F027-06</b>	6 pcs/box	A8	G
Pediatric green bulb	<b>Y05-F022-06</b>	6 pcs/box	B1	H

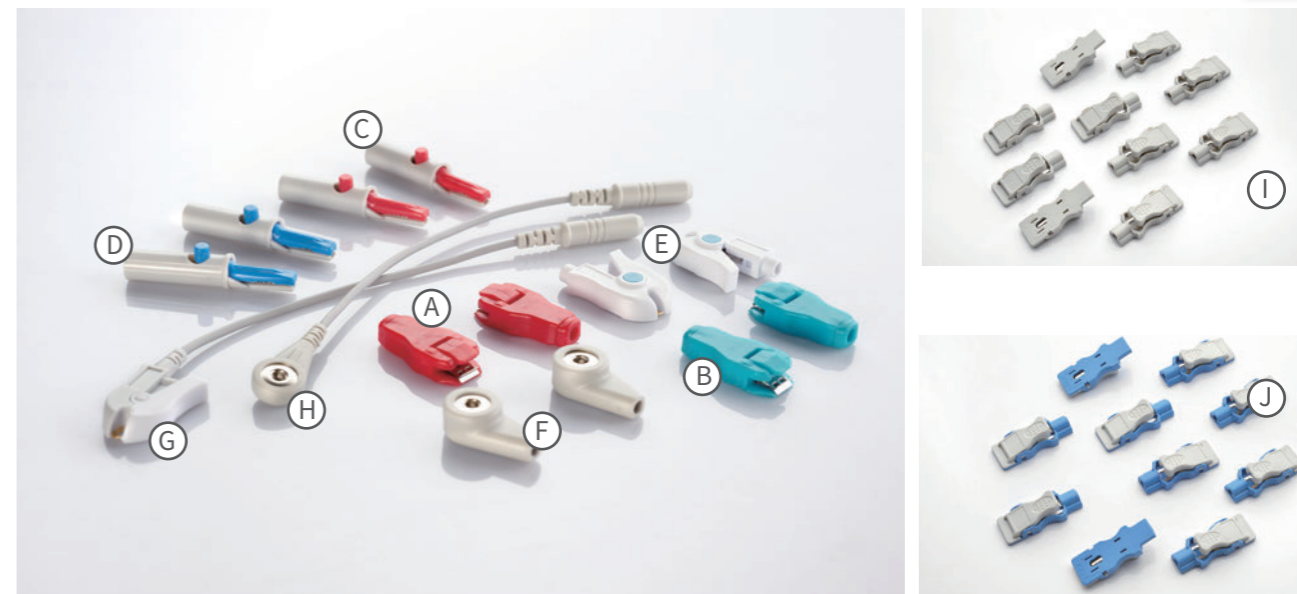

ECG Electrodes	REF#	Package	Price (box)	REF to Figures
Adult Limb Clamps/IEC (snap, grabber, 3mm needle, 4mm banana)	<b>UU-LC-A-01</b>	4 pcs/box	B4.1	A
Adult limb clamps/IEC(3mm needle, 4mm banana)	<b>UU-LC-A-02</b>	4 pcs/box	B4.1	B
Adult limb clamps/IEC/smooth surface (3mm needle, 4mm banana)	<b>UU-LC-A-03</b>	4 pcs/box	B4	C
Adult limb clamps/IEC/Agcl plating (multifunctional)	<b>UU-LC-A-04</b>	4 pcs/box	B6.7	D
Adult limb clamps/IEC/Nickel plating (multifunctional)	<b>UU-LC-A-05</b>	4 pcs/box	<b>B5.3</b>	E
Adult limb clamps/blue (Grabber, snap, 3mm needle, 4mm banana)	<b>UU-LC-A-06</b>	4 pcs/box	B4.1	F
Adult suction electrodes/gray (universal)	<b>UU-SE-A-01</b>	6 pcs/box	B5	G
Pediatric limb clamps/IEC/Agcl plating (Snap, grabber, 3mm needle and 4mm banana)	<b>UU-LC-P-01</b>	4 pcs/box	B6.5	H

ECG Electrodes	REF#	Package	Price (box)	REF to Figures
* Flat clip/red adapter/w 4mm banana	<b>AD-BF-10</b>	10 pcs/bag	B7	A
* Flat clip/blue adapter/ w 3mm needle	<b>AD-NF-10</b>	10 pcs/bag	B7	B
Alligator clip/red adapter/w 4mm banana	<b>AD-BA-10</b>	10 pcs/bag	B7	C
Alligator clip/blue adapter/w 3mm needle	<b>AD-NA-10</b>	10 pcs/bag	B7	D
Adapter/4mm with grabber end	<b>AD-BP-10</b>	10 pcs/bag	B7	E
Adapter/3mm needle with grabber end	<b>AD-NP-10</b>	10 pcs/bag	B8	E
Adapter/4mm with snap end	<b>AD-BS-10</b>	10 pcs/bag	B7	F
Adapter/3mm needle with snap end	<b>AD-NS-10</b>	10 pcs/bag	B8	F
Wide mouth multi-function adapter/4mm with banana end	<b>AD-BW-10</b>	10 pcs/bag	B7	I
Wide mouth multi-function adapter/3mm with needle end	<b>AD-NW-10</b>	10 pcs/bag	B8	J
Adapter wire/4mm with grabber end, 0.17m	<b>AD-B-P</b>	10 pcs/bag	C1.4	G
Adapter wire/3mm with grabber end, 0.17m	<b>AD-N-P</b>	10 pcs/bag	C1.4	G
Adapter wire/4mm with snap end, 0.17m	<b>AD-B-S</b>	10 pcs/bag	C1.4	H
Adapter wire/3mm with snap end, 0.17m	<b>AD-N-S</b>	10 pcs/bag	C1.4	H

Items indicated “\* ” are not sold in the USA.





# SpO<sub>2</sub> Sensor & Interface Cable

- 1. Reusable SpO<sub>2</sub> Sensor ..... 059
- 2. Disposable SpO<sub>2</sub> Sensor ..... 155
- 3. SpO<sub>2</sub> Interface Cable ..... 165
- 4. Accessories ..... 187
- 5. SpO<sub>2</sub> Adapter ..... 188
- 6. New Style SpO<sub>2</sub> Sensor(Adult Finger Clip) ..... 191

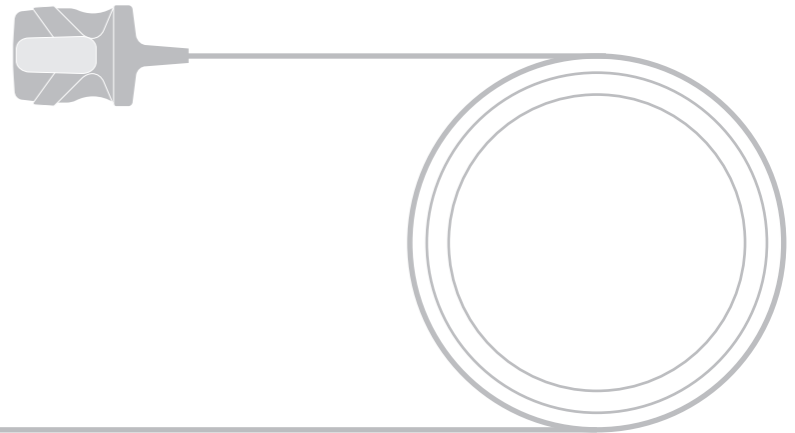

**Certification**



**Compliance with**

ISO 15223-1:2021	IEC 60601-1:2005
ISO 10993-1:2018	IEC 60601-1-2:2014
ISO 10993-5:2009	IEC 60601-1-6:2010
ISO 10993-10:2021	IEC 62366-1:2015
ISO 10993-23:2021	ISO 80601-2-61:2017
ISO 14971:2019	ISO 13485:2016

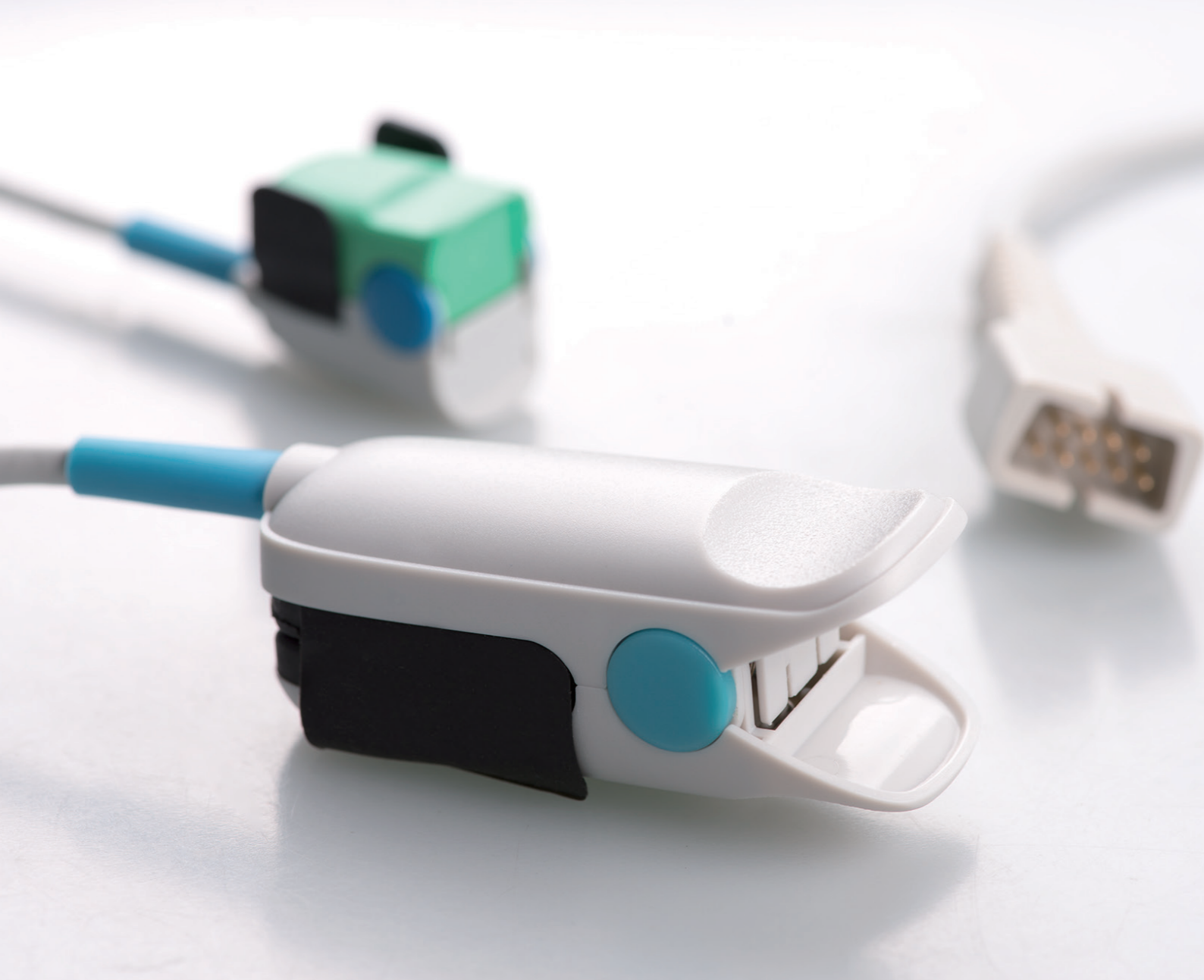

### Compatible with Major Patient Monitor Brands

Ohmeda  
Philips  
Marquette  
Spacelabs  
Novamatrix

Criticare  
BCI  
Datascopie  
Datex  
Nihon Kohden  
Palco  
.....

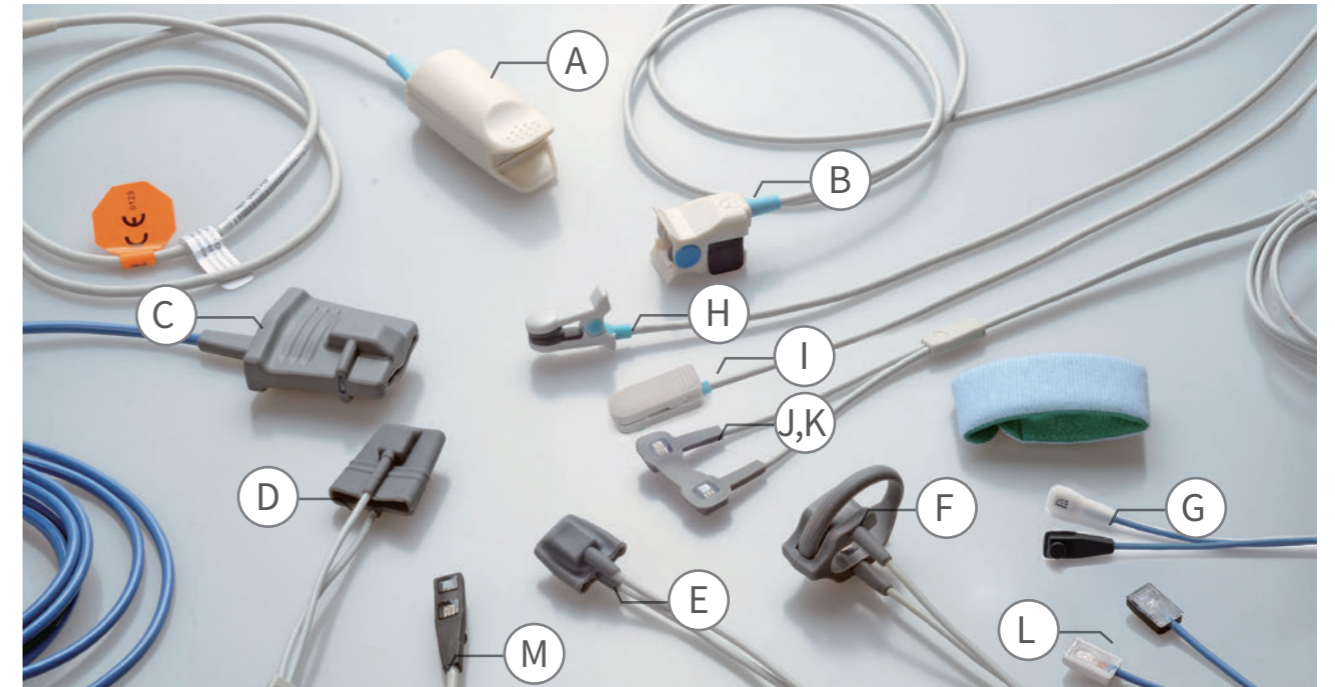

## 1 Reusable SpO<sub>2</sub> Sensor

### Specification

Sensor connector	OEM compatible, Nylon adapter with gold plated pins
Cable material & color	TPU jacket; light gray or blue
Cable length & diameter	1.1m/1.5m/3.0m; $\phi$ 3.20mm/4.00mm or 5.00x2.50mm two line cable
Sensor house	ABS shell(finger clip); Silicon rubber boots( soft tip and multi-site)

Series	U400	U100	U400S	U100S	U200S	U300	
REF to Fig	A	B	C	D	E	F	
Name	Adult Finger Clip	Pediatric Finger Clip	Adult Soft Tip	Pediatric Soft Tip	Infant Soft Tip	Neonate Wrap	
Patient size	+40kg	15-40kg	+40kg	15-40kg	3-15kg	1-3kg	
Cable color	Gray cable	Gray cable	Blue cable	Gray two line	Gray two line	Gray two line	
Series	U800	U900	U900N	U600	U600B	U800E	U800V
REF to Fig	G	H	I	J	K	L	M
Name	Multi-site	Adult ear clip	Adult/Neo. Wrap	Pedia/Inf. Wrap	Multi-site	Forehead/Rectal	
Patient size	All patients	+40kg	+40kg or -3kg	15-40kg	All patients	Adult	
Cable color	Gray two line	Gray cable	Gray two line	Gray two line	Sensormate used with DPT tapes	Gray cable	





### Search by OEM Manufacturers

3F Medical ..... 063	GE Healthcare > Hellige ..... 104	Newtech ..... 131
Adecon ..... 063	General Meditech ..... 104	Nihon Kohden ..... 132
Advanced Instrumentations ..... 063	Generra ..... 105	Nonin ..... 134
Anke ..... 064	Guoteng ..... 105	Northern Meditec ..... 135
ARI Medical ..... 065	Heal Force ..... 106	Novamatrix ..... 135
Armstrong ..... 065	Healthdyne ..... 106	Omron > Colin ..... 136
Artema/S&W ..... 066	HwaTime ..... 107	Oridion ..... 137
Baxter ..... 066	Huntleigh ..... 107	Osen ..... 137
BCI/Smiths Medical ..... 067	Infinium ..... 107	PaceTech ..... 138
Biocare ..... 067	Innocare ..... 108	Palco ..... 138
Biolight ..... 069	Invivo ..... 109	Philips ..... 139
Bionet ..... 072	Ivy Biomedical ..... 109	Philips > Goldway ..... 140
Biosys ..... 073	IBIO R&DT ..... 110	RGB Medical ..... 143
Brainer ..... 073	Jeteem ..... 110	Risingmed ..... 143
Bruker ..... 074	Jumbor ..... 111	Schiller ..... 143
CareFusion > Alaris ..... 074	Kernel ..... 111	Senmind ..... 146
Carewell ..... 074	Kontron ..... 111	Simed ..... 146
CAS Medical ..... 075	Konica Minolta ..... 112	Sinohero ..... 146
Charmcare ..... 076	Konsung Medical ..... 112	Solaris ..... 147
ChoiceMMed(Beijing Choice) ..... 077	LG Medical Design ..... 113	Spacelabs ..... 147
Comen ..... 078	Lohmeier ..... 113	Takaoka ..... 149
Contec ..... 081	Lumeon ..... 113	TianRong ..... 149
Corpuls ..... 082	Lutech ..... 113	Triton ..... 149
Creative ..... 082	M-Tech ..... 114	Unicare ..... 150
Criticare/CSI* ..... 083	MDE ..... 115	Uray ..... 151
Digicare ..... 084	MedChoice ..... 116	Utech ..... 151
Digital-Tech ..... 085	Medec ..... 116	UTAS ..... 152
Dima ..... 085	Medexcel ..... 117	Votem ..... 152
Dixon ..... 086	Mediaid ..... 117	Welch Allyn ..... 153
Dixtal ..... 087	Mediana ..... 117	Zoll ..... 153
Dolphin ..... 088	Mediblu ..... 118	Zondan ..... 154
Draeger/Dräger > Siemens ..... 088	Medica D ..... 118	
DRE ..... 091	Medtronic > Physio Control ..... 119	
DST ..... 093	Medlab ..... 120	
Edan ..... 093	MEK ..... 120	
Fukuda Denshi ..... 095	Mennen ..... 122	
FJBF ..... 095	Midmark > Cardell ..... 123	
GE Healthcare > Marquette ..... 095	Mindray > Datascope ..... 123	
GE TruSignal/OxyTip+ ..... 097	M&B/Mbelec ..... 129	
GE Healthcare > Corometrics ..... 098	NCC ..... (SPO: ADAPTER CABLE) 180	
GE Healthcare > Critikon > Dinamap ..... 099	NE-Tech ..... 129	
GE Healthcare > Datex Ohmeda ..... 100	Neusoft ..... 130	







### How to Identify the REF# of Unimed SpO<sub>2</sub> Sensors

#### Reference Number Rule Description

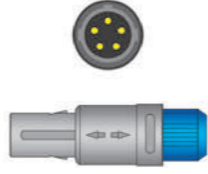
U403S-01PE	
U	Unimed brand
4	Adult sensor (1: pediatric; 2: infant; 3: neonate; 5: disposable; 6: wrap; 7: ext-cable; 8: multi-site; 9: ear clip)
03	1.1m cable length (03: 1.1m; 05: 1.5m; 08: 2.2m; 10: 3.0m)
S	Soft tip sensor (b: U style shell; default: shell sensor or neonate wrap, alternative wrap, multi-site)
01	Ne tech code (02: ohmeda; 03: novamatrix; 04: spacelabs; 05: criticare; 06: bci...)
P	Oximax technology (m: m technology, d: digital technology; default: standard Models ending in x can be used with models ending in xp & p)
E	Sensormate sensor (default: non-sensormate sensor)









Cross Reference

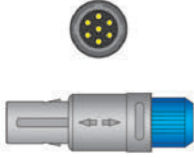
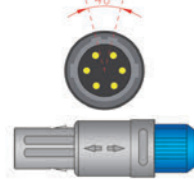



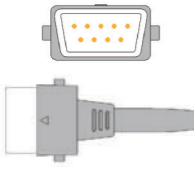



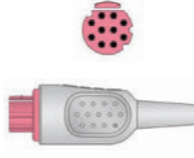

OEM Manufacturer & Models	Sensor Connector	REF# OEM	REF# UNIMED	Sensor Descriptions	Price (unit)	Ext - Cable	Monitor End Conn.	Sensor End Conn.
<b>3F Medical</b>								
IRIS 300,IRIS 400 PhoebePro PMS8300 PhoebePro PWS8310 PhoebePro PMS8110A			<b>U110-189</b>	Pediatric finger clip, 3.0m	C8	Direct		
			<b>U110S-189</b>	Pediatric soft tip, 3.0m	C8			
			<b>U210S-189</b>	Infant soft tip, 3.0m	C8			
			<b>U310-189</b>	Neonate wrap, 3.0m	C8			
			<b>U410-189</b>	Adult finger clip, 3.0m	C7			
			<b>U410S-189</b>	Adult soft tip, 3.0m	C8			
			<b>U610-189</b>	Adult/Neonate wrap, 3.0m	C7			
			<b>U610B-189</b>	Pediatric/Infant wrap, 3.0m	C7			
			<b>U810-189</b>	Multi-site, 3.0m	C7			
			<b>U910-189</b>	Adult ear clip, 3.0m	C8			
				See NE-Tech (OxiSmart) U*03-01 Series Sensor	1.1m			
<b>Adecon</b>								
MCF-21L, DK-8000D,DK-8000L			<b>U110-120</b>	Pediatric finger clip, 3.0m	C8	Direct		
			<b>U110S-120</b>	Pediatric soft tip, 3.0m	C8			
			<b>U210S-120</b>	Infant soft tip, 3.0m	C8			
			<b>U310-120</b>	Neonate wrap, 3.0m	C8			
			<b>U410-120</b>	Adult finger clip, 3.0m	C7			
			<b>U410S-120</b>	Adult soft tip, 3.0m	C8			
			<b>U610-120</b>	Adult/Neonate wrap, 3.0m	C7			
			<b>U610B-120</b>	Pediatric/Infant wrap, 3.0m	C7			
			<b>U810-120</b>	Multi-site, 3.0m	C7			
			<b>U910-120</b>	Adult ear clip, 3.0m	C8			
				See NE-Tech (OxiSmart) U*03-01 Series Sensor	1.1m			
<b>Advanced Instrumentations</b>								
PM-2000A Pro, PM1000F			<b>U110-29</b>	Pediatric finger clip, 3.0m	C7	Direct		
			<b>U110S-29</b>	Pediatric soft tip, 3.0m	C7			
			<b>U210S-29</b>	Infant soft tip, 3.0m	C7			
			<b>U310-29</b>	Neonate wrap, 3.0m	C7			
			<b>U410-29</b>	Adult finger clip, 3.0m	C5			
			<b>U410S-29</b>	Adult soft tip, 3.0m	C7			
			<b>U610-29</b>	Adult/Neonate wrap, 3.0m	C5			
			<b>U610B-29</b>	Pediatric/Infant wrap, 3.0m	C5			
			<b>U810-29</b>	Multi-site, 3.0m	C5			
			<b>U910-29</b>	Adult ear clip, 3.0m	C7			
				See NE-Tech (OxiSmart) U*03-01 Series Sensor	1.1m			

OEM Manufacturer & Models	Sensor Connector	REF# OEM	REF# UNIMED	Sensor Descriptions	Price (unit)	Ext - Cable	Monitor End Conn.	Sensor End Conn.
<b>Anke</b>								
ASC-553			<b>U110-37</b>	Pediatric finger clip, 3.0m	C8	Direct		
			<b>U110S-37</b>	Pediatric soft tip, 3.0m	C8			
			<b>U210S-37</b>	Infant soft tip, 3.0m	C8			
			<b>U310-37</b>	Neonate wrap, 3.0m	C8			
			<b>U410-37</b>	Adult finger clip, 3.0m	C7			
			<b>U410S-37</b>	Adult soft tip, 3.0m	C8			
			<b>U610-37</b>	Adult/Neonate wrap, 3.0m	C7			
			<b>U610B-37</b>	Pediatric/Infant wrap, 3.0m	C7			
			<b>U810-37</b>	Multi-site, 3.0m	C7			
			<b>U910-37</b>	Adult ear clip, 3.0m	C8			
				See NE-Tech (OxiSmart) U*03-01 Series Sensor	1.1m			
ASC-553 (*NE-Tech OxiMax)			<b>U110-78P</b>	Pediatric finger clip, 3.0m	D1	Direct		
			<b>U110S-78P</b>	Pediatric soft tip, 3.0m	D1			
			<b>U210S-78P</b>	Infant soft tip, 3.0m	D1			
			<b>U310-78P</b>	Neonate wrap, 3.0m	D1			
			<b>U410-78P</b>	Adult finger clip, 3.0m	C8			
			<b>U410S-78P</b>	Adult soft tip, 3.0m	D1			
			<b>U610-78P</b>	Adult/Neonate wrap, 3.0m	C8			
			<b>U610B-78P</b>	Pediatric/Infant wrap, 3.0m	C8			
			<b>U810-78P</b>	Multi-site, 3.0m	C8			
			<b>U910-78P</b>	Adult ear clip, 3.0m	D1			
				See NE-Tech (OxiMax) U*03-01P Series Sensor	1.1m			
ASC-553A			<b>U110-82</b>	Pediatric finger clip, 3.0m	C8	Direct		
			<b>U110S-82</b>	Pediatric soft tip, 3.0m	C8			
			<b>U210S-82</b>	Infant soft tip, 3.0m	C8			
			<b>U310-82</b>	Neonate wrap, 3.0m	C8			
			<b>U410-82</b>	Adult finger clip, 3.0m	C7			
			<b>U410S-82</b>	Adult soft tip, 3.0m	C8			
			<b>U610-82</b>	Adult/Neonate wrap, 3.0m	C7			
			<b>U610B-82</b>	Pediatric/Infant wrap, 3.0m	C7			
			<b>U810-82</b>	Multi-site, 3.0m	C7			
			<b>U910-82</b>	Adult ear clip, 3.0m	C8			
				See NE-Tech (OxiSmart) U*03-01 Series Sensor	1.1m			

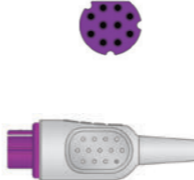



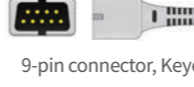





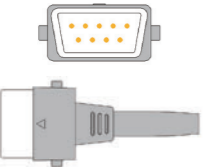

Anke Next Page

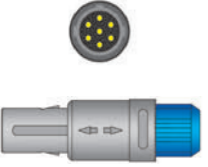



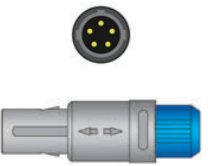

OEM Manufacturer & Models	Sensor Connector	REF# OEM	REF# UNIMED	Sensor Descriptions	Price (unit)	Ext - Cable	Monitor End Conn.	Sensor End Conn.
<b>Anke</b>								
ASC-553A			<b>U110-107</b>	Pediatric finger clip, 3.0m	C8	Direct		
			<b>U110S-107</b>	Pediatric soft tip, 3.0m	C8			
			<b>U210S-107</b>	Infant soft tip, 3.0m	C8			
			<b>U310-107</b>	Neonate wrap, 3.0m	C8			
			<b>U410-107</b>	Adult finger clip, 3.0m	C7			
			<b>U410S-107</b>	Adult soft tip, 3.0m	C8			
			<b>U610-107</b>	Adult/Neonate wrap, 3.0m	C7			
			<b>U610B-107</b>	Pediatric/Infant wrap, 3.0m	C7			
			<b>U810-107</b>	Multi-site, 3.0m	C7			
			<b>U910-107</b>	Adult ear clip, 3.0m	C8			
<b>ARI Medical</b>								
ARI-800C			<b>U110-29</b>	Pediatric finger clip, 3.0m	C7	Direct		
			<b>U110S-29</b>	Pediatric soft tip, 3.0m	C7			
			<b>U210S-29</b>	Infant soft tip, 3.0m	C7			
			<b>U310-29</b>	Neonate wrap, 3.0m	C7			
			<b>U410-29</b>	Adult finger clip, 3.0m	C5			
			<b>U410S-29</b>	Adult soft tip, 3.0m	C7			
			<b>U610-29</b>	Adult/Neonate wrap, 3.0m	C5			
			<b>U610B-29</b>	Pediatric/Infant wrap, 3.0m	C5			
			<b>U810-29</b>	Multi-site, 3.0m	C5			
			<b>U910-29</b>	Adult ear clip, 3.0m	C7			
		See NE-Tech (OxiSmart) U*03-01 Series Sensor	2.2m		U708-29			
<b>Armstrong</b>								
AD-1000, AD-2000, AD-3000, AD-4000, AD-900 (*BCI Tech)			<b>U110-06</b>	Pediatric finger clip, 3.0m	C7	Direct		
			<b>U110S-06</b>	Pediatric soft tip, 3.0m	C7			
			<b>U210S-06</b>	Infant soft tip, 3.0m	C7			
			<b>U310-06</b>	Neonate wrap, 3.0m	C7			
			<b>U410-06</b>	Adult finger clip, 3.0m	C5			
			<b>U410S-06</b>	Adult soft tip, 3.0m	C7			
			<b>U610-06</b>	Adult/Neonate wrap, 3.0m	C5			
			<b>U610B-06</b>	Pediatric/Infant wrap, 3.0m	C5			
			<b>U810-06</b>	Multi-site, 3.0m	C5			
			<b>U910-06</b>	Adult ear clip, 3.0m	C7			
		See BCI U*03-06 Series Sensor	2.2m		U708-06			

OEM Manufacturer & Models	Sensor Connector	REF# OEM	REF# UNIMED	Sensor Descriptions	Price (unit)	Ext - Cable	Monitor End Conn.	Sensor End Conn.
<b>Artema/S&amp;W</b>								
Diascope 8000,Athena Diascope 1,Diascope 2, Diascope 3,Diascope G2			<b>U110-80</b>	Pediatric finger clip, 3.0m	D1	Direct		
			<b>U110S-80</b>	Pediatric soft tip, 3.0m	D1			
			<b>U210S-80</b>	Infant soft tip, 3.0m	D1			
			<b>U310-80</b>	Neonate wrap, 3.0m	D1			
			<b>U410-80</b>	Adult finger clip, 3.0m	C8			
			<b>U410S-80</b>	Adult soft tip, 3.0m	D1			
			<b>U610-80</b>	Adult/Neonate wrap, 3.0m	C8			
			<b>U610B-80</b>	Pediatric/Infant wrap, 3.0m	C8			
			<b>U810-80</b>	Multi-site, 3.0m	C8			
			<b>U910-80</b>	Adult ear clip, 3.0m	D1			
		See NE-Tech (OxiSmart) U*03-01 Series Sensor	2.2m		U708-80			
Diascope P9301A			<b>U110-19</b>	Pediatric finger clip, 3.0m	D1	Direct		
			<b>U110S-19</b>	Pediatric soft tip, 3.0m	D1			
			<b>U210S-19</b>	Infant soft tip, 3.0m	D1			
			<b>U310-19</b>	Neonate wrap, 3.0m	D1			
			<b>U410-19</b>	Adult finger clip, 3.0m	C8			
			<b>U410S-19</b>	Adult soft tip, 3.0m	D1			
			<b>U610-19</b>	Adult/Neonate wrap, 3.0m	C8			
			<b>U610B-19</b>	Pediatric/Infant wrap, 3.0m	C8			
			<b>U810-19</b>	Multi-site, 3.0m	C8			
			<b>U910-19</b>	Adult ear clip, 3.0m	D1			
		See NE-Tech (OxiSmart) U*03-01 Series Sensor	2.2m		U708-19			
<b>Baxter</b>								
ASAT			<b>U110-12</b>	Pediatric finger clip, 3.0m	C8	Direct		
			<b>U110S-12</b>	Pediatric soft tip, 3.0m	C8			
			<b>U210S-12</b>	Infant soft tip, 3.0m	C8			
			<b>U310-12</b>	Neonate wrap, 3.0m	C8			
			<b>U410-12</b>	Adult finger clip, 3.0m	C7			
			<b>U410S-12</b>	Adult soft tip, 3.0m	C8			
			<b>U610-12</b>	Adult/Neonate wrap, 3.0m	C7			
			<b>U610B-12</b>	Pediatric/Infant wrap, 3.0m	C7			
			<b>U810-12</b>	Multi-site, 3.0m	C7			
			<b>U910-12</b>	Adult ear clip, 3.0m	C8			
		See NE-Tech (OxiSmart) U*03-01 Series Sensor	2.2m		U708-12			

Baxter Next Page



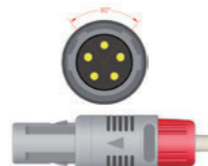





OEM Manufacturer & Models	Sensor Connector	REF# OEM	REF# UNIMED	Sensor Descriptions	Price (unit)	Ext - Cable	Monitor End Conn.	Sensor End Conn.
<b>Baxter</b>								
Explorer, Monarch (*NE-Tech OxiMax)	 9-pin connector, Keyed	See NE-Tech (OxiMax) U*03-01P Series Sensor		2.2m		U708-71	 	
<b>BCI/Smiths Medical</b>								
1300, 1301, 1302, 1303, 3100, 3101, 3180, 3300, 3301, 3302, 3303, 3304, 3400, 3401, 3403, 3404, 3444, 4700, 6100, 9100, 9200, Advisor, Autocorr, Capnocheck 9004, Mini Torr, Mini Torr Plus, Spectro 10, Spectro 20, Spectro2 10, Spectro2 20, Spectro2 30, SurgiVet, Vet/Ox Plus 4600 (*BCI Tech) (U*03-06 Series)	 9-pin connector	3178	<b>U103-06</b>	Pediatric finger clip, 1.1m	C5	U708-06	 	
			<b>U103S-06</b>	Pediatric soft tip, 1.1m	C5			
			<b>U203S-06</b>	Infant soft tip, 1.1m	C5			
			<b>U303-06</b>	Neonate wrap, 1.1m	C5			
		3044/3444	<b>U403-06</b>	Adult finger clip, 1.1m	C3.8			
			<b>U403S-06</b>	Adult soft tip, 1.1m	C5			
		3025	<b>U603-06</b>	Adult/Neonate wrap, 1.1m	C3.8			
1300, 1301, 3180, 3300, 3404, 3444, 4700, 6100, 9100, Advisor, Autocorr, Mini Torr, Mini Torr Plus, Vet/Ox Plus 4600 (*BCI Tech)	 7-pin lemo connector, 1 notch		<b>U110-76</b>	Pediatric finger clip, 3.0m	C8	Direct		
			<b>U110S-76</b>	Pediatric soft tip, 3.0m	C8			
			<b>U210S-76</b>	Infant soft tip, 3.0m	C8			
			<b>U310-76</b>	Neonate wrap, 3.0m	C8			
			<b>U410-76</b>	Adult finger clip, 3.0m	C7			
			<b>U410S-76</b>	Adult soft tip, 3.0m	C8			
			<b>U610-76</b>	Adult/Neonate wrap, 3.0m	C7			
			<b>U610B-76</b>	Pediatric/Infant wrap, 3.0m	C7			
			<b>U810-76</b>	Multi-site, 3.0m	C7			
			<b>U910-76</b>	Adult ear clip, 3.0m	C8			
	 9-pin connector	See BCI U*03-06 Series Sensor		2.2m		U708-76	 	
<b>Biocare</b>								
BM-9000, BM-9000S FM-801, FM-801V (*Digital Tech)	 5-pin lemo connector, 1 notch		<b>U110-62D</b>	Pediatric finger clip, 3.0m	D1	Direct		
			<b>U110S-62D</b>	Pediatric soft tip, 3.0m	D1			
			<b>U210S-62D</b>	Infant soft tip, 3.0m	D1			
			<b>U310-62D</b>	Neonate wrap, 3.0m	D1			
			<b>U410-62D</b>	Adult finger clip, 3.0m	C8			
			<b>U410S-62D</b>	Adult soft tip, 3.0m	D1			
			<b>U610-62D</b>	Adult/Neonate wrap, 3.0m	C8			
			<b>U610B-62D</b>	Pediatric/Infant wrap, 3.0m	C8			
			<b>U810-62D</b>	Multi-site, 3.0m	C8			
			<b>U910-62D</b>	Adult ear clip, 3.0m	D1			
	 9-pin connector	See Biolight Digital U*03-62D Series Sensor		2.2m		U708-62	 	

Biocare Next Page

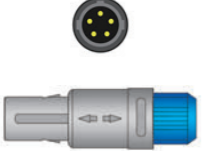









OEM Manufacturer & Models	Sensor Connector	REF# OEM	REF# UNIMED	Sensor Descriptions	Price (unit)	Ext - Cable	Monitor End Conn.	Sensor End Conn.
<b>Biocare</b>								
PM-900	 6-pin lemo connector, 1 notch		<b>U110-143</b>	Pediatric finger clip, 3.0m	C8	Direct		
			<b>U110S-143</b>	Pediatric soft tip, 3.0m	C8			
			<b>U210S-143</b>	Infant soft tip, 3.0m	C8			
			<b>U310-143</b>	Neonate wrap, 3.0m	C8			
			<b>U410-143</b>	Adult finger clip, 3.0m	C7			
			<b>U410S-143</b>	Adult soft tip, 3.0m	C8			
			<b>U610-143</b>	Adult/Neonate wrap, 3.0m	C7			
			<b>U610B-143</b>	Pediatric/Infant wrap, 3.0m	C7			
			<b>U810-143</b>	Multi-site, 3.0m	C7			
			<b>U910-143</b>	Adult ear clip, 3.0m	C8			
	 9-pin connector, Keyed	See NE-Tech (OxiSmart) U*03-01 Series Sensor		2.2m		U708-143	 	
BM-9000	 6-pin lemo connector, 1 notch		<b>U110-29</b>	Pediatric finger clip, 3.0m	C7	Direct		
			<b>U110S-29</b>	Pediatric soft tip, 3.0m	C7			
			<b>U210S-29</b>	Infant soft tip, 3.0m	C7			
			<b>U310-29</b>	Neonate wrap, 3.0m	C7			
			<b>U410-29</b>	Adult finger clip, 3.0m	C5			
			<b>U410S-29</b>	Adult soft tip, 3.0m	C7			
			<b>U610-29</b>	Adult/Neonate wrap, 3.0m	C5			
			<b>U610B-29</b>	Pediatric/Infant wrap, 3.0m	C5			
			<b>U810-29</b>	Multi-site, 3.0m	C5			
			<b>U910-29</b>	Adult ear clip, 3.0m	C7			
	 9-pin connector, Keyed	See NE-Tech (OxiSmart) U*03-01 Series Sensor		2.2m		U708-29	 	
BP-12B, BP-12C (*Digital Tech)	 5-pin lemo connector, 2 notches, 80° keyed		<b>U110-61D</b>	Pediatric finger clip, 3.0m	C8	Direct		
			<b>U110S-61D</b>	Pediatric soft tip, 3.0m	C8			
			<b>U210S-61D</b>	Infant soft tip, 3.0m	C8			
			<b>U310-61D</b>	Neonate wrap, 3.0m	C8			
			<b>U410-61D</b>	Adult finger clip, 3.0m	C7			
			<b>U410S-61D</b>	Adult soft tip, 3.0m	C8			
			<b>U610-61D</b>	Adult/Neonate wrap, 3.0m	C7			
			<b>U610B-61D</b>	Pediatric/Infant wrap, 3.0m	C7			
			<b>U810-61D</b>	Multi-site, 3.0m	C7			
			<b>U910-61D</b>	Adult ear clip, 3.0m	C8			
	 9-pin connector, Keyed	See Digital Tech U*03-42D Series Sensor		2.2m		U708-61	 	

Biocare Next Page

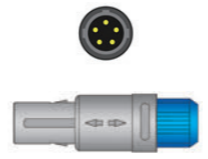



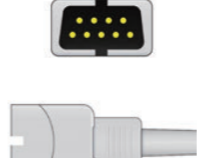











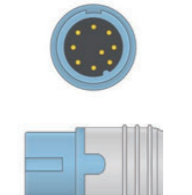





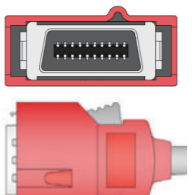







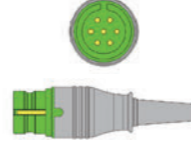

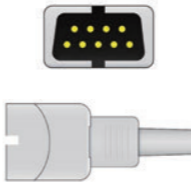
OEM Manufacturer & Models	Sensor Connector	REF# OEM	REF# UNIMED	Sensor Descriptions	Price (unit)	Ext - Cable	Monitor End Conn.	Sensor End Conn.
Biocare								
iM15			<b>U110-223</b>	Pediatric finger clip, 3.0m	C8	Direct		
			<b>U110S-223</b>	Pediatric soft tip, 3.0m	C8			
			<b>U210S-223</b>	Infant soft tip, 3.0m	C8			
			<b>U310-223</b>	Neonate wrap, 3.0m	C8			
			<b>U410-223</b>	Adult finger clip, 3.0m	C7			
			<b>U410S-223</b>	Adult soft tip, 3.0m	C8			
			<b>U610-223</b>	Adult/Neonate wrap, 3.0m	C7			
			<b>U610B-223</b>	Pediatric/Infant wrap, 3.0m	C7			
			<b>U810-223</b>	Multi-site, 3.0m	C7			
			<b>U910-223</b>	Adult ear clip, 3.0m	C8			
		See NE-Tech (OxiSmart) U*03-01 Series Sensor	2.2m		U708-223			
Biolight								
M6, M12, M66, M69, M9000			<b>U110-47</b>	Pediatric finger clip, 3.0m	C7	Direct		
			<b>U110S-47</b>	Pediatric soft tip, 3.0m	C7			
			<b>U210S-47</b>	Infant soft tip, 3.0m	C7			
			<b>U310-47</b>	Neonate wrap, 3.0m	C7			
			<b>U410-47</b>	Adult finger clip, 3.0m	C5			
			<b>U410S-47</b>	Adult soft tip, 3.0m	C7			
			<b>U610-47</b>	Adult/Neonate wrap, 3.0m	C5			
			<b>U610B-47</b>	Pediatric/Infant wrap, 3.0m	C5			
			<b>U810-47</b>	Multi-site, 3.0m	C5			
			<b>U910-47</b>	Adult ear clip, 3.0m	C7			
		See NE-Tech (OxiSmart) U*03-01 Series Sensor	2.2m		U708-47			
M66, M69 (Old)			<b>U110-57</b>	Pediatric finger clip, 3.0m	C8	Direct		
			<b>U110S-57</b>	Pediatric soft tip, 3.0m	C8			
			<b>U210S-57</b>	Infant soft tip, 3.0m	C8			
			<b>U310-57</b>	Neonate wrap, 3.0m	C8			
			<b>U410-57</b>	Adult finger clip, 3.0m	C7			
			<b>U410S-57</b>	Adult soft tip, 3.0m	C8			
			<b>U610-57</b>	Adult/Neonate wrap, 3.0m	C7			
			<b>U610B-57</b>	Pediatric/Infant wrap, 3.0m	C7			
			<b>U810-57</b>	Multi-site, 3.0m	C7			
			<b>U910-57</b>	Adult ear clip, 3.0m	C8			

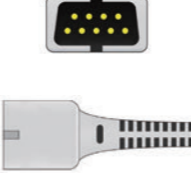
Biolight Next Page

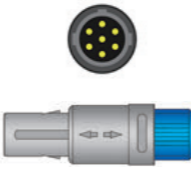



OEM Manufacturer & Models	Sensor Connector	REF# OEM	REF# UNIMED	Sensor Descriptions	Price (unit)	Ext - Cable	Monitor End Conn.	Sensor End Conn.
Biolight								
BLT M8500 (*NE-Tech OxiMax)			<b>U110-51P</b>	Pediatric finger clip, 3.0m	D1	Direct		
			<b>U110S-51P</b>	Pediatric soft tip, 3.0m	D1			
			<b>U210S-51P</b>	Infant soft tip, 3.0m	D1			
			<b>U310-51P</b>	Neonate wrap, 3.0m	D1			
			<b>U410-51P</b>	Adult finger clip, 3.0m	C8			
			<b>U410S-51P</b>	Adult soft tip, 3.0m	D1			
			<b>U610-51P</b>	Adult/Neonate wrap, 3.0m	C8			
			<b>U610B-51P</b>	Pediatric/Infant wrap, 3.0m	C8			
			<b>U810-51P</b>	Multi-site, 3.0m	C8			
			<b>U910-51P</b>	Adult ear clip, 3.0m	D1			
		See NE-Tech (OxiMax) U*03-01P Series Sensor	3.0m		U710X-51 (15-100-0016)			
M12, M6, M66, M69, M8000, M8000A, M8500, M9000, M9000A, MTD-352A (*Digital Tech)			<b>U110-62D</b>	Pediatric finger clip, 3.0m	D1	Direct		
			<b>U110S-62D</b>	Pediatric soft tip, 3.0m	D1			
			<b>U210S-62D</b>	Infant soft tip, 3.0m	D1			
			<b>U310-62D</b>	Neonate wrap, 3.0m	D1			
			<b>U410-62D</b>	Adult finger clip, 3.0m	C8			
			<b>U410S-62D</b>	Adult soft tip, 3.0m	D1			
			<b>U610-62D</b>	Adult/Neonate wrap, 3.0m	C8			
			<b>U610B-62D</b>	Pediatric/Infant wrap, 3.0m	C8			
			<b>U810-62D</b>	Multi-site, 3.0m	C8			
			<b>U910-62D</b>	Adult ear clip, 3.0m	D1			
		See Biolight Digital U*03-62D Series Sensor	2.2m		U708-62			
M700, M800, M900A Hand-Held vet (*Digital Tech) (U*03-62D)			<b>U103-62D</b>	Pediatric finger clip, 1.1m	<b>C8.7</b>	Direct		
			<b>U103S-62D</b>	Pediatric soft tip, 1.1m	<b>C8.7</b>			
			<b>U203S-62D</b>	Infant soft tip, 1.1m	<b>C8.7</b>			
			<b>U303-62D</b>	Neonate wrap, 1.1m	<b>C8.7</b>			
			<b>U403-62D</b>	Adult finger clip, 1.1m	<b>C8.1</b>			
			<b>U403S-62D</b>	Adult soft tip, 1.1m	<b>C8.7</b>			
			<b>U603-62D</b>	Adult/Neonate wrap, 1.1m	<b>C8.1</b>			
			<b>U603B-62D</b>	Pediatric/Infant wrap, 1.1m	<b>C8.1</b>			
			<b>U803-62D</b>	Multi-site, 1.1m	<b>C8.1</b>			
			<b>U903-62D</b>	Adult ear clip, 1.1m	<b>C8.7</b>			







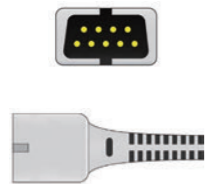
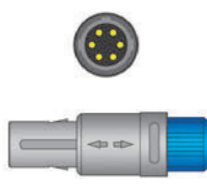

Biolight Next Page

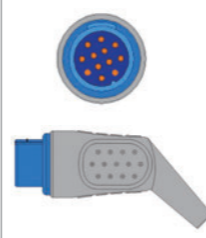
OEM Manufacturer & Models	Sensor Connector	REF# OEM	REF# UNIMED	Sensor Descriptions	Price (unit)	Ext - Cable	Monitor End Conn.	Sensor End Conn.
<b>Biolight</b>								
M900,M7000,M8500,M9500 (*Digital Tech)	 12-pin connector, keyed		<b>U110-68D</b>	Pediatric finger clip, 3.0m	D1	Direct		
			<b>U110S-68D</b>	Pediatric soft tip, 3.0m	D1			
			<b>U210S-68D</b>	Infant soft tip, 3.0m	D1			
			<b>U310-68D</b>	Neonate wrap, 3.0m	D1			
			<b>U410-68D</b>	Adult finger clip, 3.0m	C8			
			<b>U410S-68D</b>	Adult soft tip, 3.0m	D1			
			<b>U610-68D</b>	Adult/Neonate wrap, 3.0m	C8			
			<b>U610B-68D</b>	Pediatric/Infant wrap, 3.0m	C8			
			<b>U810-68D</b>	Multi-site, 3.0m	C8			
			<b>U910-68D</b>	Adult ear clip, 3.0m	D1			
	 9-pin connector, Keyed	See Biolight Digital U*03-62D Series Sensor		2.2m		U708-68		
Anyview A2E/A3/A5/A6/A8 BLT A3,BLT A4,BLT A5,BLT A6,BLT V6,BLT A7 BLT Q3-Q4-Q5-Q6-Q7 (*Digital Tech)	 9-pin connector, keyed		<b>U110-205D</b>	Pediatric finger clip, 3.0m	<b>D1</b>	Direct		
			<b>U110S-205D</b>	Pediatric soft tip, 3.0m	<b>D1</b>			
			<b>U210S-205D</b>	Infant soft tip, 3.0m	<b>D1</b>			
			<b>U310-205D</b>	Neonate wrap, 3.0m	<b>D1</b>			
			<b>U410-205D</b>	Adult finger clip, 3.0m	<b>C8</b>			
			<b>U410S-205D</b>	Adult soft tip, 3.0m	<b>D1</b>			
			<b>U610-205D</b>	Adult/Neonate wrap, 3.0m	<b>C8</b>			
			<b>U610B-205D</b>	Pediatric/Infant wrap, 3.0m	<b>C8</b>			
			<b>U810-205D</b>	Multi-site, 3.0m	<b>C8</b>			
			<b>U910-205D</b>	Adult ear clip, 3.0m	<b>D1</b>			
	 9-pin connector, Keyed	See Biolight Digital U*03-62D Series Sensor		2.2m		U708-261		
AnyView A3 (*M-Tech)	 20-pin connector, keyed		<b>U110-87</b>	Pediatric finger clip, 3.0m	D3	Direct		
			<b>U110S-87</b>	Pediatric soft tip, 3.0m	D3			
			<b>U210S-87</b>	Infant soft tip, 3.0m	D3			
			<b>U310-87</b>	Neonate wrap, 3.0m	D3			
			<b>U410-87</b>	Adult finger clip, 3.0m	D2			
			<b>U410S-87</b>	Adult soft tip, 3.0m	D3			
			<b>U610-87</b>	Adult/Neonate wrap, 3.0m	D2			
			<b>U610B-87</b>	Pediatric/Infant wrap, 3.0m	D2			
			<b>U810-87</b>	Multi-site, 3.0m	D2			
			<b>U910-87</b>	Adult ear clip, 3.0m	D3			
	 9-pin connector, Keyed	See M-Tech U*03-49R Series Sensor		2.2m		U708M-87		

OEM Manufacturer & Models	Sensor Connector	REF# OEM	REF# UNIMED	Sensor Descriptions	Price (unit)	Ext - Cable	Monitor End Conn.	Sensor End Conn.	
<b>Bionet</b>									
BM1,BM3,BM5,BM7	 7-pin connector, keyed		<b>U110-108</b>	Pediatric finger clip, 3.0m	C8	Direct			
			<b>U110S-108</b>	Pediatric soft tip, 3.0m	C8				
			<b>U210S-108</b>	Infant soft tip, 3.0m	C8				
			<b>U310-108</b>	Neonate wrap, 3.0m	C8				
			<b>U410-108</b>	Adult finger clip, 3.0m	C7				
			<b>U410S-108</b>	Adult soft tip, 3.0m	C8				
			<b>U610-108</b>	Adult/Neonate wrap, 3.0m	C7				
			<b>U610B-108</b>	Pediatric/Infant wrap, 3.0m	C7				
			<b>U810-108</b>	Multi-site, 3.0m	C7				
			<b>U910-108</b>	Adult ear clip, 3.0m	C8				
	 9-pin connector, keyed		<b>U103-108</b>	Pediatric finger clip, 1.1m	C5	U708-108			
			<b>U103S-108</b>	Pediatric soft tip, 1.1m	C5				
			<b>U203S-108</b>	Infant soft tip, 1.1m	C5				
			<b>U303-108</b>	Neonate wrap, 1.1m	C5				
			<b>U403-108</b>	Adult finger clip, 1.1m	C3.8				
			<b>U403S-108</b>	Adult soft tip, 1.1m	C5				
			<b>U603-108</b>	Adult/Neonate wrap, 1.1m	C3.8				
			<b>U603B-108</b>	Pediatric/Infant wrap, 1.1m	C3.8				
			<b>U803-108</b>	Multi-site, 1.1m	C3.8				
		<b>U903-108</b>	Adult ear clip, 1.1m	C5					
 9-pin connector, keyed		<b>U103-01</b>	Pediatric finger clip, 1.1m	C5	U708-114 152600-004002				
		<b>U103S-01</b>	Pediatric soft tip, 1.1m	C5					
		<b>U203S-01</b>	Infant soft tip, 1.1m	C5					
		<b>U303-01</b>	Neonate wrap, 1.1m	C5					
		<b>U403-01</b>	Adult finger clip, 1.1m	C3.8					
		<b>U403S-01</b>	Adult soft tip, 1.1m	C5					
		<b>U603-01</b>	Adult/Neonate wrap, 1.1m	C3.8					
		<b>U603B-01</b>	Pediatric/Infant wrap, 1.1m	C3.8					
		<b>U803-01</b>	Multi-site, 1.1m	C3.8					
		<b>U903-01</b>	Adult ear clip, 1.1m	C5					
BM3Plus,BM3Wide	 7-pin lemo connector, 1 notch		<b>U110-58</b>	Pediatric finger clip, 3.0m	C8	Direct			
			<b>U110S-58</b>	Pediatric soft tip, 3.0m	C8				
			<b>U210S-58</b>	Infant soft tip, 3.0m	C8				
			<b>U310-58</b>	Neonate wrap, 3.0m	C8				
			<b>U410-58</b>	Adult finger clip, 3.0m	C7				
			<b>U410S-58</b>	Adult soft tip, 3.0m	C8				
			<b>U610-58</b>	Adult/Neonate wrap, 3.0m	C7				
			<b>U610B-58</b>	Pediatric/Infant wrap, 3.0m	C7				
			<b>U810-58</b>	Multi-site, 3.0m	C7				
			<b>U910-58</b>	Adult ear clip, 3.0m	C8				
	 9-pin connector, Keyed	See NE-Tech (OxiSmart) U*03-01 Series Sensor		2.2m			U708-58		

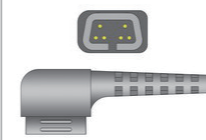
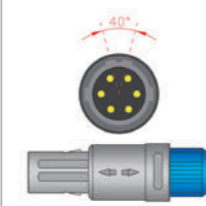







OEM Manufacturer & Models	Sensor Connector	REF# OEM	REF# UNIMED	Sensor Descriptions	Price (unit)	Ext - Cable	Monitor End Conn.	Sensor End Conn.
<b>Biosys</b>								
BPM-300			<b>U110-27</b>	Pediatric finger clip, 3.0m	D1	Direct		
			<b>U110S-27</b>	Pediatric soft tip, 3.0m	D1			
			<b>U210S-27</b>	Infant soft tip, 3.0m	D1			
			<b>U310-27</b>	Neonate wrap, 3.0m	D1			
			<b>U410-27</b>	Adult finger clip, 3.0m	C8			
			<b>U410S-27</b>	Adult soft tip, 3.0m	D1			
			<b>U610-27</b>	Adult/Neonate wrap, 3.0m	C8			
			<b>U610B-27</b>	Pediatric/Infant wrap, 3.0m	C8			
			<b>U810-27</b>	Multi-site, 3.0m	C8			
			<b>U910-27</b>	Adult ear clip, 3.0m	D1			
		See NE-Tech (OxiSmart) U*03-01 Series Sensor	2.2m		U708-27			
BPM-200, B-PM-700, Guardian, SENTRY (*NE Tech OxiSmart)			<b>U110-01</b>	Pediatric finger clip, 3.0m	C7	Direct		
			<b>U110S-01</b>	Pediatric soft tip, 3.0m	C7			
			<b>U210S-01</b>	Infant soft tip, 3.0m	C7			
			<b>U310-01</b>	Neonate wrap, 3.0m	C7			
			<b>U410-01</b>	Adult finger clip, 3.0m	C5			
			<b>U410S-01</b>	Adult soft tip, 3.0m	C7			
			<b>U610-01</b>	Adult/Neonate wrap, 3.0m	C5			
			<b>U610B-01</b>	Pediatric/Infant wrap, 3.0m	C5			
			<b>U810-01</b>	Multi-site, 3.0m	C5			
	<b>U910-01</b>	Adult ear clip, 3.0m	C7					
<b>Brainer</b>								
DS-100			<b>U110-188</b>	Pediatric finger clip, 3.0m	C8	Direct		
			<b>U110S-188</b>	Pediatric soft tip, 3.0m	C8			
			<b>U210S-188</b>	Infant soft tip, 3.0m	C8			
			<b>U310-188</b>	Neonate wrap, 3.0m	C8			
			<b>U410-188</b>	Adult finger clip, 3.0m	C7			
			<b>U410S-188</b>	Adult soft tip, 3.0m	C8			
			<b>U610-188</b>	Adult/Neonate wrap, 3.0m	C7			
			<b>U610B-188</b>	Pediatric/Infant wrap, 3.0m	C7			
			<b>U810-188</b>	Multi-site, 3.0m	C7			
	<b>U910-188</b>	Adult ear clip, 3.0m	C8					

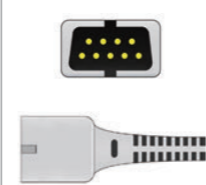
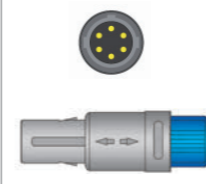

OEM Manufacturer & Models	Sensor Connector	REF# OEM	REF# UNIMED	Sensor Descriptions	Price (unit)	Ext - Cable	Monitor End Conn.	Sensor End Conn.
<b>Bruker</b>								
DC-3002, IH, M3			<b>U110-63</b>	Pediatric finger clip, 3.0m	C8	Direct		
			<b>U110S-63</b>	Pediatric soft tip, 3.0m	C8			
			<b>U210S-63</b>	Infant soft tip, 3.0m	C8			
			<b>U310-63</b>	Neonate wrap, 3.0m	C8			
			<b>U410-63</b>	Adult finger clip, 3.0m	C7			
			<b>U410S-63</b>	Adult soft tip, 3.0m	C8			
			<b>U610-63</b>	Adult/Neonate wrap, 3.0m	C7			
			<b>U610B-63</b>	Pediatric/Infant wrap, 3.0m	C7			
			<b>U810-63</b>	Multi-site, 3.0m	C7			
			<b>U910-63</b>	Adult ear clip, 3.0m	C8			
		See NE-Tech (OxiSmart) U*03-01 Series Sensor	2.2m		U708-63			
<b>CareFusion &gt; Alaris</b>								
VitalCheck 4400, VitalCheck 4410 (*CSI Tech)			<b>U110-75</b>	Pediatric finger clip, 3.0m	C8	Direct		
			<b>U110S-75</b>	Pediatric soft tip, 3.0m	C8			
			<b>U210S-75</b>	Infant soft tip, 3.0m	C8			
			<b>U310-75</b>	Neonate wrap, 3.0m	C8			
			<b>U410-75</b>	Adult finger clip, 3.0m	C7			
			<b>U410S-75</b>	Adult soft tip, 3.0m	C8			
			<b>U610-75</b>	Adult/Neonate wrap, 3.0m	C7			
			<b>U610B-75</b>	Pediatric/Infant wrap, 3.0m	C7			
			<b>U810-75</b>	Multi-site, 3.0m	C7			
	<b>U910-75</b>	Adult ear clip, 3.0m	C8					
<b>Carewell</b>								
CPM-9000T			<b>U110-29</b>	Pediatric finger clip, 3.0m	C7	Direct		
			<b>U110S-29</b>	Pediatric soft tip, 3.0m	C7			
			<b>U210S-29</b>	Infant soft tip, 3.0m	C7			
			<b>U310-29</b>	Neonate wrap, 3.0m	C7			
			<b>U410-29</b>	Adult finger clip, 3.0m	C5			
			<b>U410S-29</b>	Adult soft tip, 3.0m	C7			
			<b>U610-29</b>	Adult/Neonate wrap, 3.0m	C5			
			<b>U610B-29</b>	Pediatric/Infant wrap, 3.0m	C5			
			<b>U810-29</b>	Multi-site, 3.0m	C5			
			<b>U910-29</b>	Adult ear clip, 3.0m	C7			
		See NE-Tech (OxiSmart) U*03-01 Series Sensor	2.2m		U708-29			

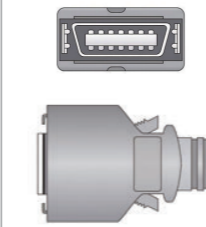
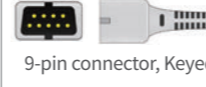
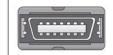



Carewell Next Page

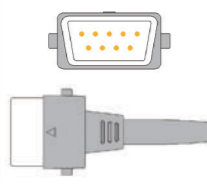
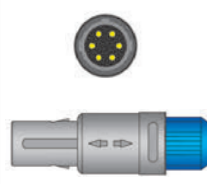
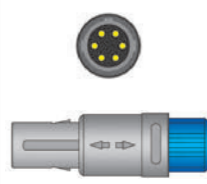
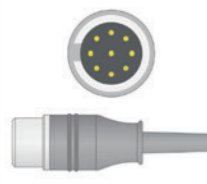



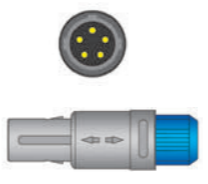





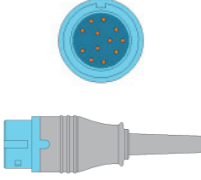

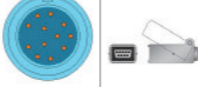

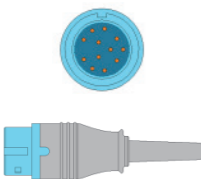
OEM Manufacturer & Models	Sensor Connector	REF# OEM	REF# UNIMED	Sensor Descriptions	Price (unit)	Ext - Cable	Monitor End Conn.	Sensor End Conn.
<b>Carewell</b>								
CPM-9000W (*Digital Tech)	 6-pin lemo connector, 1 notch		<b>U110-66D</b>	Pediatric finger clip, 3.0m	D1	Direct		
			<b>U110S-66D</b>	Pediatric soft tip, 3.0m	D1			
			<b>U210S-66D</b>	Infant soft tip, 3.0m	D1			
			<b>U310-66D</b>	Neonate wrap, 3.0m	D1			
			<b>U410-66D</b>	Adult finger clip, 3.0m	C8			
			<b>U410S-66D</b>	Adult soft tip, 3.0m	D1			
			<b>U610-66D</b>	Adult/Neonate wrap, 3.0m	C8			
			<b>U610B-66D</b>	Pediatric/Infant wrap, 3.0m	C8			
			<b>U810-66D</b>	Multi-site, 3.0m	C8			
			<b>U910-66D</b>	Adult ear clip, 3.0m	D1			
	 9-pin connector, Keyed	See Digital Tech U*03-42D Series Sensor	2.2m		U708-45			
<b>CAS Medical</b>								
740(M), 750(M) (*M-Tech)	 14-pin connector		<b>U110-15R</b>	Pediatric finger clip, 3.0m	D1	Direct		
			<b>U110S-15R</b>	Pediatric soft tip, 3.0m	D1			
			<b>U210S-15R</b>	Infant soft tip, 3.0m	D1			
			<b>U310-15R</b>	Neonate wrap, 3.0m	D1			
			<b>U410-15R</b>	Adult finger clip, 3.0m	C8			
			<b>U410S-15R</b>	Adult soft tip, 3.0m	D1			
			<b>U610-15R</b>	Adult/Neonate wrap, 3.0m	C8			
			<b>U610B-15R</b>	Pediatric/Infant wrap, 3.0m	C8			
			<b>U810-15R</b>	Multi-site, 3.0m	C8			
			<b>U910-15R</b>	Adult ear clip, 3.0m	D1			
	 9-pin connector, Keyed	See M-Tech U*03-49R Series Sensor	2.2m		U708M-15R			
Oscillomate 9002/9303/9302S (*Nonin Tech)	 9-pin connector, keyed		<b>U103-08</b>	Pediatric finger clip , 1.1m	C5	U708-08L		
			<b>U103S-08</b>	Pediatric soft tip , 1.1m	C5			
			<b>U203S-08</b>	Infant soft tip , 1.1m	C5			
			<b>U303-08</b>	Neonate wrap , 1.1m	C5			
			<b>U403-08</b>	Adult finger clip , 1.1m	C3.8			
			<b>U403S-08</b>	Adult soft tip , 1.1m	C5			
			<b>U603-08</b>	Adult/Neonate wrap , 1.1m	C3.8			
			<b>U603B-08</b>	Pediatric/Infant wrap , 1.1m	C3.8			
			<b>U803-08</b>	Multi-site , 1.1m	C3.8			
			<b>U903-08</b>	Adult ear clip , 1.1m	C5			

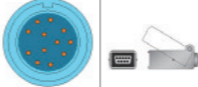
OEM Manufacturer & Models	Sensor Connector	REF# OEM	REF# UNIMED	Sensor Descriptions	Price (unit)	Ext - Cable	Monitor End Conn.	Sensor End Conn.
<b>Charmcare</b>								
CX100, ACCURO (*NE Tech OxiSmart)	 9-pin connector, keyed		<b>U110-01</b>	Pediatric finger clip, 3.0m	C7	Direct		
			<b>U110S-01</b>	Pediatric soft tip, 3.0m	C7			
			<b>U210S-01</b>	Infant soft tip, 3.0m	C7			
			<b>U310-01</b>	Neonate wrap, 3.0m	C7			
			<b>U410-01</b>	Adult finger clip, 3.0m	C5			
			<b>U410S-01</b>	Adult soft tip, 3.0m	C7			
			<b>U610-01</b>	Adult/Neonate wrap, 3.0m	C5			
			<b>U610B-01</b>	Pediatric/Infant wrap, 3.0m	C5			
			<b>U810-01</b>	Multi-site, 3.0m	C5			
			<b>U910-01</b>	Adult ear clip, 3.0m	C7			
PRIZM 3	 6-pin lemo connector, 1 notch		<b>U110-153</b>	Pediatric finger clip, 3.0m	C8	Direct		
			<b>U110S-153</b>	Pediatric soft tip, 3.0m	C8			
			<b>U210S-153</b>	Infant soft tip, 3.0m	C8			
			<b>U310-153</b>	Neonate wrap, 3.0m	C8			
			<b>U410-153</b>	Adult finger clip, 3.0m	C7			
			<b>U410S-153</b>	Adult soft tip, 3.0m	C8			
			<b>U610-153</b>	Adult/Neonate wrap, 3.0m	C7			
			<b>U610B-153</b>	Pediatric/Infant wrap, 3.0m	C7			
			<b>U810-153</b>	Multi-site, 3.0m	C7			
			<b>U910-153</b>	Adult ear clip, 3.0m	C8			
	 9-pin connector, Keyed	See NE-Tech (OxiSmart) U*03-01 Series Sensor	2.2m		U708-153			
ACCURO II RAPIDO II	 14-pin connector		<b>U110-246</b>	Pediatric finger clip, 3.0m	<b>C8.7</b>	Direct		
			<b>U110S-246</b>	Pediatric soft tip, 3.0m	<b>C8.7</b>			
			<b>U210S-246</b>	Infant soft tip, 3.0m	<b>C8.7</b>			
			<b>U310-246</b>	Neonate wrap, 3.0m	<b>C8.7</b>			
			<b>U410-246</b>	Adult finger clip, 3.0m	<b>C8.2</b>			
			<b>U410S-246</b>	Adult soft tip, 3.0m	<b>C8.7</b>			
			<b>U610-246</b>	Adult/Neonate wrap, 3.0m	<b>C8.2</b>			
			<b>U610B-246</b>	Pediatric/Infant wrap, 3.0m	<b>C8.2</b>			
			<b>U810-246</b>	Multi-site, 3.0m	<b>C8.2</b>			
			<b>U910-246</b>	Adult ear clip, 3.0m	<b>C8.7</b>			
	 9-pin connector, Keyed	See NE-Tech (OxiSmart) U*03-01 Series Sensor	2.2m		U708-246			

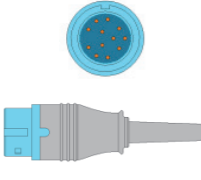

OEM Manufacturer & Models	Sensor Connector	REF# OEM	REF# UNIMED	Sensor Descriptions	Price (unit)	Ext - Cable	Monitor End Conn.	Sensor End Conn.		
ChoiceMMed(Beijing Choice)										
MMED3001,MD300K MA300K2,MD300M, MMED6000DP-M3 (*BCI Tech)			<b>U103-06</b>	Pediatric finger clip , 1.1m	C5	Direct				
			<b>U103S-06</b>	Pediatric soft tip , 1.1m	C5					
			<b>U203S-06</b>	Infant soft tip , 1.1m	C5					
			<b>U303-06</b>	Neonate wrap , 1.1m	C5					
			<b>U403-06</b>	Adult finger clip , 1.1m	C3.8					
			<b>U403S-06</b>	Adult soft tip , 1.1m	C5					
			<b>U603-06</b>	Adult/Neonate wrap , 1.1m	C3.8					
			<b>U603B-06</b>	Pediatric/Infant wrap , 1.1m	C3.8					
			<b>U803-06</b>	Multi-site , 1.1m	C3.8					
	<b>U903-06</b>	Adult ear clip , 1.1m	C5							
MMED100H,MMED300A, MMED6000DP (*Digital Tech)			<b>U110-84D</b>	Pediatric finger clip, 3.0m	D1	Direct				
			<b>U110S-84D</b>	Pediatric soft tip, 3.0m	D1					
			<b>U210S-84D</b>	Infant soft tip, 3.0m	D1					
			<b>U310-84D</b>	Neonate wrap, 3.0m	D1					
			<b>U410-84D</b>	Adult finger clip, 3.0m	C8					
			<b>U410S-84D</b>	Adult soft tip, 3.0m	D1					
			<b>U610-84D</b>	Adult/Neonate wrap, 3.0m	C8					
			<b>U610B-84D</b>	Pediatric/Infant wrap, 3.0m	C8					
			<b>U810-84D</b>	Multi-site, 3.0m	C8					
	<b>U910-84D</b>	Adult ear clip, 3.0m	D1							
MMED6000DP-M12 MMED6000DP-S6 MMED6000DP-P61 (*BCI Tech)			<b>U110-96</b>	Pediatric finger clip, 3.0m	C8	Direct				
			<b>U110S-96</b>	Pediatric soft tip, 3.0m	C8					
			<b>U210S-96</b>	Infant soft tip, 3.0m	C8					
			<b>U310-96</b>	Neonate wrap, 3.0m	C8					
			<b>U410-96</b>	Adult finger clip, 3.0m	C7					
			<b>U410S-96</b>	Adult soft tip, 3.0m	C8					
			<b>U610-96</b>	Adult/Neonate wrap, 3.0m	C7					
			<b>U610B-96</b>	Pediatric/Infant wrap, 3.0m	C7					
			<b>U810-96</b>	Multi-site, 3.0m	C7					
			<b>U910-96</b>	Adult ear clip, 3.0m	C8					
			See BCI U*03-06 Series Sensor		2.2m					U708-96
	MD200B			<b>U110-229</b>	Pediatric finger clip, 3.0m				To be updated	Direct
			<b>U110S-229</b>	Pediatric soft tip, 3.0m	To be updated					
			<b>U210S-229</b>	Infant soft tip, 3.0m	To be updated					
			<b>U310-229</b>	Neonate wrap, 3.0m	To be updated					
			<b>U410-229</b>	Adult finger clip, 3.0m	To be updated					
			<b>U410S-229</b>	Adult soft tip, 3.0m	To be updated					
			<b>U610-229</b>	Adult/Neonate wrap, 3.0m	To be updated					
			<b>U610B-229</b>	Pediatric/Infant wrap, 3.0m	To be updated					
			<b>U810-229</b>	Multi-site, 3.0m	To be updated					
			<b>U910-229</b>	Adult ear clip, 3.0m	To be updated					
		See NE-Tech (OxiSmart) U*03-01 Series Sensor		2.2m		U708-229				

OEM Manufacturer & Models	Sensor Connector	REF# OEM	REF# UNIMED	Sensor Descriptions	Price (unit)	Ext - Cable	Monitor End Conn.	Sensor End Conn.			
ChoiceMMed(Beijing Choice)											
MMED6000DP-SF			<b>U110-37</b>	Pediatric finger clip, 3.0m	C8	Direct					
			<b>U110S-37</b>	Pediatric soft tip, 3.0m	C8						
			<b>U210S-37</b>	Infant soft tip, 3.0m	C8						
			<b>U310-37</b>	Neonate wrap, 3.0m	C8						
			<b>U410-37</b>	Adult finger clip, 3.0m	C7						
			<b>U410S-37</b>	Adult soft tip, 3.0m	C8						
			<b>U610-37</b>	Adult/Neonate wrap, 3.0m	C7						
			<b>U610B-37</b>	Pediatric/Infant wrap, 3.0m	C7						
			<b>U810-37</b>	Multi-site, 3.0m	C7						
			<b>U910-37</b>	Adult ear clip, 3.0m	C8						
	9-pin connector, Keyed	See NE-Tech (OxiSmart) U*03-01 Series Sensor		2.2m		U708-37					
Comen											
C60 (old version) (*M-Tech)			<b>U110-202M</b>	Pediatric finger clip, 3.0m	D3	Direct					
			<b>U110S-202M</b>	Pediatric soft tip, 3.0m	D3						
			<b>U210S-202M</b>	Infant soft tip, 3.0m	D3						
			<b>U310-202M</b>	Neonate wrap, 3.0m	D3						
			<b>U410-202M</b>	Adult finger clip, 3.0m	D2						
			<b>U410S-202M</b>	Adult soft tip, 3.0m	D3						
			<b>U610-202M</b>	Adult/Neonate wrap, 3.0m	D2						
			<b>U610B-202M</b>	Pediatric/Infant wrap, 3.0m	D2						
			<b>U810-202M</b>	Multi-site, 3.0m	D2						
			<b>U910-202M</b>	Adult ear clip, 3.0m	D3						
			9-pin connector, Keyed	See M-Tech U*03-49R Series Sensor					2.2m		U708M-202
	C20,C60,C80,C90			<b>U110-208</b>	Pediatric finger clip, 3.0m				C7	Direct	
			<b>U110S-208</b>	Pediatric soft tip, 3.0m	C7						
			<b>U210S-208</b>	Infant soft tip, 3.0m	C7						
			<b>U310-208</b>	Neonate wrap, 3.0m	C7						
			<b>U410-208</b>	Adult finger clip, 3.0m	C5						
			<b>U410S-208</b>	Adult soft tip, 3.0m	C7						
			<b>U610-208</b>	Adult/Neonate wrap, 3.0m	C5						
			<b>U610B-208</b>	Pediatric/Infant wrap, 3.0m	C5						
			<b>U810-208</b>	Multi-site, 3.0m	C5						
		<b>U910-208</b>	Adult ear clip, 3.0m	C7							
	9-pin connector, Keyed	See NE-Tech (OxiSmart) U*03-01 Series Sensor		2.2m		U708-208					











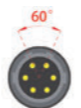

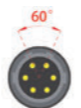

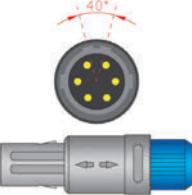
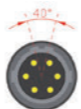
OEM Manufacturer & Models	Sensor Connector	REF# OEM	REF# UNIMED	Sensor Descriptions	Price (unit)	Ext - Cable	Monitor End Conn.	Sensor End Conn.
Comen								
C21,C30,C50,C70,C80,C100, C100A,NC3,NC5,NC8,NC12, NC19 (*Digital Tech)			<b>U110-208D</b>	Pediatric finger clip, 3.0m	C7	Direct		
			<b>U110S-208D</b>	Pediatric soft tip, 3.0m	C7			
			<b>U210S-208D</b>	Infant soft tip, 3.0m	C7			
			<b>U310-208D</b>	Neonate wrap, 3.0m	C7			
			<b>U410-208D</b>	Adult finger clip, 3.0m	C5			
			<b>U410S-208D</b>	Adult soft tip, 3.0m	C7			
			<b>U610-208D</b>	Adult/Neonate wrap, 3.0m	C5			
			<b>U610B-208D</b>	Pediatric/Infant wrap, 3.0m	C5			
			<b>U810-208D</b>	Multi-site, 3.0m	C5			
			<b>U910-208D</b>	Adult ear clip, 3.0m	C7			
		See Digital Tech U*03-42D Series Sensor	2.2m		U708-208D			
C20,C60,C80,C90 (*M-Tech Rainbow)			<b>U110-208MR</b>	Pediatric finger clip, 3.0m	D1.3	Direct		
			<b>U110S-208MR</b>	Pediatric soft tip, 3.0m	D1.3			
			<b>U210S-208MR</b>	Infant soft tip, 3.0m	D1.3			
			<b>U310-208MR</b>	Neonate wrap, 3.0m	D1.3			
			<b>U410-208MR</b>	Adult finger clip, 3.0m	C8.7			
			<b>U410S-208MR</b>	Adult soft tip, 3.0m	D1.3			
			<b>U610-208MR</b>	Adult/Neonate wrap, 3.0m	C8.7			
			<b>U610B-208MR</b>	Pediatric/Infant wrap, 3.0m	C8.7			
			<b>U810-208MR</b>	Multi-site, 3.0m	C8.7			
			<b>U910-208MR</b>	Adult ear clip, 3.0m	D1.3			
		See M-Tech U*03-49R Series Sensor	2.2m		U708M-208R			
		See M-Tech U*03-203 Series Sensor	2.2m		U708MR-208			
C20,C60,C80,C90 (*NE-Tech OxiMax)			<b>U110-208P</b>	Pediatric finger clip, 3.0m	D1.3	Direct		
			<b>U110S-208P</b>	Pediatric soft tip, 3.0m	D1.3			
			<b>U210S-208P</b>	Infant soft tip, 3.0m	D1.3			
			<b>U310-208P</b>	Neonate wrap, 3.0m	D1.3			
			<b>U410-208P</b>	Adult finger clip, 3.0m	C8.7			
			<b>U410S-208P</b>	Adult soft tip, 3.0m	D1.3			
			<b>U610-208P</b>	Adult/Neonate wrap, 3.0m	C8.7			
			<b>U610B-208P</b>	Pediatric/Infant wrap, 3.0m	C8.7			
			<b>U810-208P</b>	Multi-site, 3.0m	C8.7			
			<b>U910-208P</b>	Adult ear clip, 3.0m	D1.3			
		See NE-Tech (OxiMax) U*03-01P Series Sensor	2.2m		U708X-208			

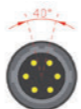
Comen Next Page

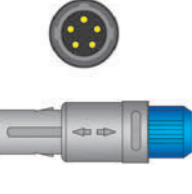









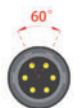

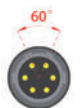
OEM Manufacturer & Models	Sensor Connector	REF# OEM	REF# UNIMED	Sensor Descriptions	Price (unit)	Ext - Cable	Monitor End Conn.	Sensor End Conn.
Comen								
C60, C80 (*NE-Tech OxiMax)			<b>U110-187P</b>	Pediatric finger clip, 3.0m	D1.3	Direct		
			<b>U110S-187P</b>	Pediatric soft tip, 3.0m	D1.3			
			<b>U210S-187P</b>	Infant soft tip, 3.0m	D1.3			
			<b>U310-187P</b>	Neonate wrap, 3.0m	D1.3			
			<b>U410-187P</b>	Adult finger clip, 3.0m	C8.7			
			<b>U410S-187P</b>	Adult soft tip, 3.0m	D1.3			
			<b>U610-187P</b>	Adult/Neonate wrap, 3.0m	C8.7			
			<b>U610B-187P</b>	Pediatric/Infant wrap, 3.0m	C8.7			
			<b>U810-187P</b>	Multi-site, 3.0m	C8.7			
			<b>U910-187P</b>	Adult ear clip, 3.0m	D1.3			
		See NE-Tech (OxiMax) U*03-01P Series Sensor	2.2m		U710X-187			
C60, C80 (*M-Tech)			<b>U110-187M</b>	Pediatric finger clip, 3.0m	D1.3	Direct		
			<b>U110S-187M</b>	Pediatric soft tip, 3.0m	D1.3			
			<b>U210S-187M</b>	Infant soft tip, 3.0m	D1.3			
			<b>U310-187M</b>	Neonate wrap, 3.0m	D1.3			
			<b>U410-187M</b>	Adult finger clip, 3.0m	C8.7			
			<b>U410S-187M</b>	Adult soft tip, 3.0m	D1.3			
			<b>U610-187M</b>	Adult/Neonate wrap, 3.0m	C8.7			
			<b>U610B-187M</b>	Pediatric/Infant wrap, 3.0m	C8.7			
			<b>U810-187M</b>	Multi-site, 3.0m	C8.7			
			<b>U910-187M</b>	Adult ear clip, 3.0m	D1.3			
		See M-Tech U*03-49R Series Sensor	2.2m		U708M-187			
Start-8000A,Start-8000B Start-8000C,Star-8000D Start-8000H,Star-5000B Start-5000C (*Digital Tech)			<b>U110-66D</b>	Pediatric finger clip, 3.0m	D1	Direct		
			<b>U110S-66D</b>	Pediatric soft tip, 3.0m	D1			
			<b>U210S-66D</b>	Infant soft tip, 3.0m	D1			
			<b>U310-66D</b>	Neonate wrap, 3.0m	D1			
			<b>U410-66D</b>	Adult finger clip, 3.0m	C8			
			<b>U410S-66D</b>	Adult soft tip, 3.0m	D1			
			<b>U610-66D</b>	Adult/Neonate wrap, 3.0m	C8			
			<b>U610B-66D</b>	Pediatric/Infant wrap, 3.0m	C8			
			<b>U810-66D</b>	Multi-site, 3.0m	C8			
			<b>U910-66D</b>	Adult ear clip, 3.0m	D1			
		See Digital Tech U*03-42D Series Sensor	2.2m		U708-45			

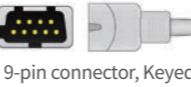
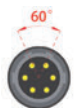
Comen Next Page

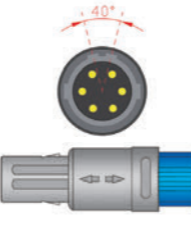

OEM Manufacturer & Models	Sensor Connector	REF# OEM	REF# UNIMED	Sensor Descriptions	Price (unit)	Ext - Cable	Monitor end Conn.	Sensor end Conn.
<b>Comen</b>								
Start-8000E	 6-pin lemo connector, 2 notches, 60° Keyed		<b>U110-183</b>	Pediatric finger clip, 3.0m	C7	Direct		
			<b>U110S-183</b>	Pediatric soft tip, 3.0m	C7			
			<b>U210S-183</b>	Infant soft tip, 3.0m	C7			
			<b>U310-183</b>	Neonate wrap, 3.0m	C7			
			<b>U410-183</b>	Adult finger clip, 3.0m	C5			
			<b>U410S-183</b>	Adult soft tip, 3.0m	C7			
			<b>U610-183</b>	Adult/Neonate wrap, 3.0m	C5			
			<b>U610B-183</b>	Pediatric/Infant wrap, 3.0m	C5			
			<b>U810-183</b>	Multi-site, 3.0m	C5			
			<b>U910-183</b>	Adult ear clip, 3.0m	C7			
	 9-pin connector, Keyed	See NE-Tech (OxiSmart) U*03-01 Series Sensor		2.2m		U708-183		
<b>Contec</b>								
HMS6500	 6-pin lemo connector, 2 notches, 40° keyed		<b>U110-29</b>	Pediatric finger clip, 3.0m	C7	Direct		
			<b>U110S-29</b>	Pediatric soft tip, 3.0m	C7			
			<b>U210S-29</b>	Infant soft tip, 3.0m	C7			
			<b>U310-29</b>	Neonate wrap, 3.0m	C7			
			<b>U410-29</b>	Adult finger clip, 3.0m	C5			
			<b>U410S-29</b>	Adult soft tip, 3.0m	C7			
			<b>U610-29</b>	Adult/Neonate wrap, 3.0m	C5			
			<b>U610B-29</b>	Pediatric/Infant wrap, 3.0m	C5			
			<b>U810-29</b>	Multi-site, 3.0m	C5			
			<b>U910-29</b>	Adult ear clip, 3.0m	C7			
	 9-pin connector, Keyed	See NE-Tech (OxiSmart) U*03-01 Series Sensor		2.2m		U708-29		
CMS60C/CW/D/DW, CMS60,PM50,PM60D CSM5000,CMS5000C, CMS5100,CMS6000, CMS7000/8000/9000, CMS5000-VET/6000-VET CMS8000-VET/60D-VET (*Digital Tech)	 5-pin lemo connector, 1 notch		<b>U110-46D</b>	Pediatric finger clip, 3.0m	C7	Direct		
			<b>U110S-46D</b>	Pediatric soft tip, 3.0m	C7			
			<b>U210S-46D</b>	Infant soft tip, 3.0m	C7			
			<b>U310-46D</b>	Neonate wrap, 3.0m	C7			
			<b>U410-46D</b>	Adult finger clip, 3.0m	C5			
			<b>U410S-46D</b>	Adult soft tip, 3.0m	C7			
			<b>U610-46D</b>	Adult/Neonate wrap, 3.0m	C5			
			<b>U610B-46D</b>	Pediatric/Infant wrap, 3.0m	C5			
			<b>U810-46D</b>	Multi-site, 3.0m	C5			
			<b>U910-46D</b>	Adult ear clip, 3.0m	C7			
	 9-pin connector, Keyed	See Digital Tech U*03-42D Series Sensor		2.2m		U708-47		











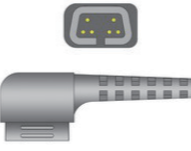

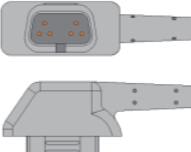

Contec Next Page

OEM Manufacturer & Models	Sensor Connector	REF# OEM	REF# UNIMED	Sensor Descriptions	Price (unit)	Ext - Cable	Monitor end Conn.	Sensor end Conn.
<b>Contec</b>								
CMS50F, CMS50FW	 5-pin lemo connector		<b>U110-149</b>	Pediatric finger clip, 3.0m	C8	Direct		
			<b>U110S-149</b>	Pediatric soft tip, 3.0m	C8			
			<b>U210S-149</b>	Infant soft tip, 3.0m	C8			
			<b>U310-149</b>	Neonate wrap, 3.0m	C8			
			<b>U410-149</b>	Adult finger clip, 3.0m	C7			
			<b>U410S-149</b>	Adult soft tip, 3.0m	C8			
			<b>U610-149</b>	Adult/Neonate wrap, 3.0m	C7			
			<b>U610B-149</b>	Pediatric/Infant wrap, 3.0m	C7			
			<b>U810-149</b>	Multi-site, 3.0m	C7			
			<b>U910-149</b>	Adult ear clip, 3.0m	C8			
<b>Corpuls</b>								
08, 16 M-Tech	 11-pin lemo connector, 1 notch, keyed		<b>U110-152M</b>	Pediatric finger clip, 3.0m	D1	Direct		
			<b>U110S-152M</b>	Pediatric soft tip, 3.0m	D1			
			<b>U210S-152M</b>	Infant soft tip, 3.0m	D1			
			<b>U310-152M</b>	Neonate wrap, 3.0m	D1			
			<b>U410-152M</b>	Adult finger clip, 3.0m	C8			
			<b>U410S-152M</b>	Adult soft tip, 3.0m	D1			
			<b>U610-152M</b>	Adult/Neonate wrap, 3.0m	C8			
			<b>U610B-152M</b>	Pediatric/Infant wrap, 3.0m	C8			
			<b>U810-152M</b>	Multi-site, 3.0m	C8			
			<b>U910-152M</b>	Adult ear clip, 3.0m	D1			
	 9-pin connector, Keyed	See M-Tech U*03-49R Series Sensor		2.2m		U708M-152		
<b>Creative</b>								
PC9000, UP-6000	 6-pin lemo connector, 2 notches, 40° keyed		<b>U110-29</b>	Pediatric finger clip, 3.0m	C7	Direct		
			<b>U110S-29</b>	Pediatric soft tip, 3.0m	C7			
			<b>U210S-29</b>	Infant soft tip, 3.0m	C7			
			<b>U310-29</b>	Neonate wrap, 3.0m	C7			
			<b>U410-29</b>	Adult finger clip, 3.0m	C5			
			<b>U410S-29</b>	Adult soft tip, 3.0m	C7			
			<b>U610-29</b>	Adult/Neonate wrap, 3.0m	C5			
			<b>U610B-29</b>	Pediatric/Infant wrap, 3.0m	C5			
			<b>U810-29</b>	Multi-site, 3.0m	C5			
			<b>U910-29</b>	Adult ear clip, 3.0m	C7			
	 9-pin connector, Keyed	See NE-Tech (OxiSmart) U*03-01 Series Sensor		2.2m		U708-29		

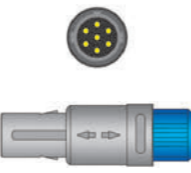
Creative Next Page



OEM Manufacturer & Models	Sensor Connector	REF# OEM	REF# UNIMED	Sensor Descriptions	Price (unit)	Ext - Cable	Monitor end Conn.	Sensor end Conn.
<b>Creative</b>								
UP-7000,UP-9000,PC-66V PC-900,PC-900A,PC-900S, PC-900SN,PC-3000,PC-66 B PC-5000A,PC-5000B,PC-9 000B,PC-66A (*Digital Tech)	 5-pin lemo connector, 2 notches, 80° keyed	15040021	U110-61D	Pediatric finger clip, 3.0m	C8	Direct		
			U110S-61D	Pediatric soft tip, 3.0m	C8			
			U210S-61D	Infant soft tip, 3.0m	C8			
			U310-61D	Neonate wrap, 3.0m	C8			
			U410-61D	Adult finger clip, 3.0m	C7			
			U410S-61D	Adult soft tip, 3.0m	C8			
			U610-61D	Adult/Neonate wrap, 3.0m	C7			
			U610B-61D	Pediatric/Infant wrap, 3.0m	C7			
			U810-61D	Multi-site, 3.0m	C7			
			U910-61D	Adult ear clip, 3.0m	C8			
	 9-pin connector, Keyed	See Digital Tech U*03-42D Series Sensor		2.2m		U708-61		
PC-900 (*NE-Tech OxiMax)	 7-pin lemo connector, 1 notch		U110-195P	Pediatric finger clip, 3.0m	D1.3	Direct		
			U110S-195P	Pediatric soft tip, 3.0m	D1.3			
			U210S-195P	Infant soft tip, 3.0m	D1.3			
			U310-195P	Neonate wrap, 3.0m	D1.3			
			U410-195P	Adult finger clip, 3.0m	C8.7			
			U410S-195P	Adult soft tip, 3.0m	D1.3			
			U610-195P	Adult/Neonate wrap, 3.0m	C8.7			
			U610B-195P	Pediatric/Infant wrap, 3.0m	C8.7			
			U810-195P	Multi-site, 3.0m	C8.7			
			U910-195P	Adult ear clip, 3.0m	D1.3			
	 9-pin connector, Keyed	See NE-Tech (OxiMax) U*03-01P Series Sensor		3.0m		U710X-195		
<b>Criticare/CSI*</b>								
1100, 2200, 500, 500A, 501, 502 series, 503, 504, 504/P, 504O/P, 504US/P, 507, 507/S, 507O/P, 507E/P/R, 507SD, 508, 509, 581, Poet (602-3A), Poni Scholar (*CSI Tech)	 5-pin metal lemo connector, 1 notch	1563-10L	U110-05	Pediatric finger clip, 3.0m	D1	Direct		
		975PD-10L	U110S-05	Pediatric soft tip, 3.0m	D1			
			U210S-05	Infant soft tip, 3.0m	D1			
			U310-05	Neonate wrap, 3.0m	D1			
		934-10LN, 511-10L	U410-05	Adult finger clip, 3.0m	C8			
		975AD-10L	U410S-05	Adult soft tip, 3.0m	D1			
			U610-05	Adult/Neonate wrap, 3.0m	C8			
			U610B-05	Pediatric/Infant wrap, 3.0m	C8			
		940-10L	U810-05	Multi-site, 3.0m	C8			
			U910-05	Adult ear clip, 3.0m	D1			
	 9-pin connector, keyed		U103-05	Pediatric finger clip, 1.1m	C4	U708-05		
			U103S-05	Pediatric soft tip, 1.1m	C4			
			U203S-05	Infant soft tip, 1.1m	C4			
			U303-05	Neonate wrap, 1.1m	C4			
			U403-05	Adult finger clip, 1.1m	C3			
			U403S-05	Adult soft tip, 1.1m	C4			
			U603-05	Adult/Neonate wrap, 1.1m	C3			
			U603B-05	Pediatric/Infant wrap, 1.1m	C3			
	U803-05	Multi-site, 1.1m	C3					
	U903-05	Adult ear clip, 1.1m	C4					





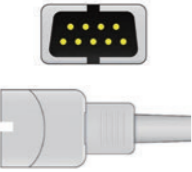

Criticare/CSI\* Next Page

OEM Manufacturer & Models	Sensor Connector	REF# OEM	REF# UNIMED	Sensor Descriptions	Price (unit)	Ext - Cable	Monitor end Conn.	Sensor end Conn.
<b>Criticare/CSI*</b>								
503 Spot, 503DX, 503DX-W, 503S, 504DX, 504DX/P, 504DXN, 506DN3, 506DNP3, 506DNT3, 506DNP3, 506DNV3, 506DNP3, 506LNP3, 506LNT3, 506LNP3, 506LNV3, 506LNP3, 506N3, 506NP3, 506NT3, 506NTP3, 506NV3, 506NVP3, 507ELC2, 8000 series, 8100 series, 8100E, 8100EP, Poet (602-3A), Poet Plus, Poet R Plus, Scholar, Scholar III, nCompass, nGenuity (*CSI Tech)	 6-pin connector, keyed		U110-75	Pediatric finger clip, 3.0m	C8	Direct		
			U110S-75	Pediatric soft tip, 3.0m	C8			
			U210S-75	Infant soft tip, 3.0m	C8			
			U310-75	Neonate wrap, 3.0m	C8			
			U410-75	Adult finger clip, 3.0m	C7			
			U410S-75	Adult soft tip, 3.0m	C8			
			U610-75	Adult/Neonate wrap, 3.0m	C7			
			U610B-75	Pediatric/Infant wrap, 3.0m	C7			
			U810-75	Multi-site, 3.0m	C7			
			U910-75	Adult ear clip, 3.0m	C8			
	 9-pin connector, Keyed	See CSI U*03-05 Series Sensor		2.2m		U708-75		
1563-10D, CAT1563-10D 934-10DN, CAT934-10DN 975AD-10, CAT975AD-10 1567-10D	 6-pin connector, keyed		U110-75N	Pediatric finger clip, 3.0m	C8	Direct		
			U110S-75N	Pediatric soft tip, 3.0m	C8			
			U210S-75N	Infant soft tip, 3.0m	C8			
			U310-75N	Neonate wrap, 3.0m	C8			
			U410-75N	Adult finger clip, 3.0m	C7			
			U410S-75N	Adult soft tip, 3.0m	C8			
			U610-75N	Adult/Neonate wrap, 3.0m	C7			
			U610B-75N	Pediatric/Infant wrap, 3.0m	C7			
			U810-75N	Multi-site, 3.0m	C7			
			U910-75N	Adult ear clip, 3.0m	C8			
<b>Digicare</b>								
Digimax 5500 (*BCI Tech)	 7-pin lemo connector, 1 notch		U110-76	Pediatric finger clip, 3.0m	C8	Direct		
			U110S-76	Pediatric soft tip, 3.0m	C8			
			U210S-76	Infant soft tip, 3.0m	C8			
			U310-76	Neonate wrap, 3.0m	C8			
			U410-76	Adult finger clip, 3.0m	C7			
			U410S-76	Adult soft tip, 3.0m	C8			
			U610-76	Adult/Neonate wrap, 3.0m	C7			
			U610B-76	Pediatric/Infant wrap, 3.0m	C7			
			U810-76	Multi-site, 3.0m	C7			
			U910-76	Adult ear clip, 3.0m	C8			
	 9-pin connector	See BCI U*03-06 Series Sensor		2.2m		U708-76		

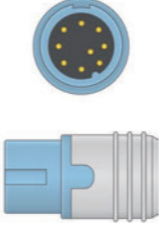
Digicare Next Page



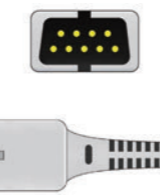



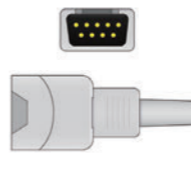
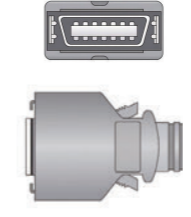
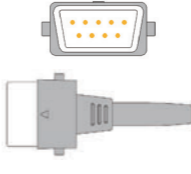
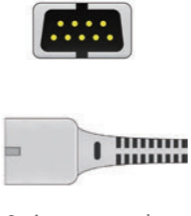

OEM Manufacturer & Models	Sensor Connector	REF# OEM	REF# UNIMED	Sensor Descriptions	Price (unit)	Ext - Cable	Monitor end Conn.	Sensor end Conn.
Digicare								
hyperton			<b>U110-52</b>	Pediatric finger clip, 3.0m	C8	Direct		
			<b>U110S-52</b>	Pediatric soft tip, 3.0m	C8			
			<b>U210S-52</b>	Infant soft tip, 3.0m	C8			
			<b>U310-52</b>	Neonate wrap, 3.0m	C8			
			<b>U410-52</b>	Adult finger clip, 3.0m	C7			
			<b>U410S-52</b>	Adult soft tip, 3.0m	C8			
			<b>U610-52</b>	Adult/Neonate wrap, 3.0m	C7			
			<b>U610B-52</b>	Pediatric/Infant wrap, 3.0m	C7			
			<b>U810-52</b>	Multi-site, 3.0m	C7			
			<b>U910-52</b>	Adult ear clip, 3.0m	C8			
		See NE-Tech (OxiSmart) U*03-01 Series Sensor	2.2m		U708-52			
Digital-Tech								
			<b>U103-42D</b>	Pediatric finger clip, 1.1m	C7	Direct		
			<b>U103S-42D</b>	Pediatric soft tip, 1.1m	C7			
			<b>U203S-42D</b>	Infant soft tip, 1.1m	C7			
			<b>U303-42D</b>	Neonate wrap, 1.1m	C7			
			<b>U403-42D</b>	Adult finger clip, 1.1m	C5			
			<b>U403S-42D</b>	Adult soft tip, 1.1m	C7			
			<b>U603-42D</b>	Adult/Neonate wrap, 1.1m	C5			
			<b>U603B-42D</b>	Pediatric/Infant wrap, 1.1m	C5			
			<b>U803-42D</b>	Multi-site, 1.1m	C5			
			<b>U903-42D</b>	Adult ear clip, 1.1m	C7			
Dima								
			<b>U103-01</b>	Pediatric finger clip, 1.1m	C5	Direct		
			<b>U103S-01</b>	Pediatric soft tip, 1.1m	C5			
			<b>U203S-01</b>	Infant soft tip, 1.1m	C5			
			<b>U303-01</b>	Neonate wrap, 1.1m	C5			
			<b>U403-01</b>	Adult finger clip, 1.1m	C3.8			
			<b>U403S-01</b>	Adult soft tip, 1.1m	C5			
			<b>U603-01</b>	Adult/Neonate wrap, 1.1m	C3.8			
			<b>U603B-01</b>	Pediatric/Infant wrap, 1.1m	C3.8			
			<b>U803-01</b>	Multi-site, 1.1m	C3.8			
			<b>U903-01</b>	Adult ear clip, 1.1m	C5			

OEM Manufacturer & Models	Sensor Connector	REF# OEM	REF# UNIMED	Sensor Descriptions	Price (unit)	Ext - Cable	Monitor end Conn.	Sensor end Conn.
Dixon								
D2,D3,D5,D6,D8 DS3,DS5,DS7 (*Digital Tech)			<b>U110-205D</b>	Pediatric finger clip, 3.0m	<b>D1</b>	Direct		
			<b>U110S-205D</b>	Pediatric soft tip, 3.0m	<b>D1</b>			
			<b>U210S-205D</b>	Infant soft tip, 3.0m	<b>D1</b>			
			<b>U310-205D</b>	Neonate wrap, 3.0m	<b>D1</b>			
			<b>U410-205D</b>	Adult finger clip, 3.0m	<b>C8</b>			
			<b>U410S-205D</b>	Adult soft tip, 3.0m	<b>D1</b>			
			<b>U610-205D</b>	Adult/Neonate wrap, 3.0m	<b>C8</b>			
			<b>U610B-205D</b>	Pediatric/Infant wrap, 3.0m	<b>C8</b>			
			<b>U810-205D</b>	Multi-site, 3.0m	<b>C8</b>			
			<b>U910-205D</b>	Adult ear clip, 3.0m	<b>D1</b>			
		See Biolight Digital U*03-62D Series Sensor	2.2m		U708-261			
M800 Hand-held vet (*Digital Tech)			<b>U103-62D</b>	Pediatric finger clip, 1.1m	<b>C8.7</b>	Direct		
			<b>U103S-62D</b>	Pediatric soft tip, 1.1m	<b>C8.7</b>			
			<b>U203S-62D</b>	Infant soft tip, 1.1m	<b>C8.7</b>			
			<b>U303-62D</b>	Neonate wrap, 1.1m	<b>C8.7</b>			
			<b>U403-62D</b>	Adult finger clip, 1.1m	<b>C8.1</b>			
			<b>U403S-62D</b>	Adult soft tip, 1.1m	<b>C8.7</b>			
			<b>U603-62D</b>	Adult/Neonate wrap, 1.1m	<b>C8.1</b>			
			<b>U603B-62D</b>	Pediatric/Infant wrap, 1.1m	<b>C8.1</b>			
			<b>U803-62D</b>	Multi-site, 1.1m	<b>C8.1</b>			
			<b>U903-62D</b>	Adult ear clip, 1.1m	<b>C8.7</b>			
Storm 5000			<b>U103-01</b>	Pediatric finger clip, 1.1m	C5	Direct		
			<b>U103S-01</b>	Pediatric soft tip, 1.1m	C5			
			<b>U203S-01</b>	Infant soft tip, 1.1m	C5			
			<b>U303-01</b>	Neonate wrap, 1.1m	C5			
			<b>U403-01</b>	Adult finger clip, 1.1m	C3.8			
			<b>U403S-01</b>	Adult soft tip, 1.1m	C5			
			<b>U603-01</b>	Adult/Neonate wrap, 1.1m	C3.8			
			<b>U603B-01</b>	Pediatric/Infant wrap, 1.1m	C3.8			
			<b>U803-01</b>	Multi-site, 1.1m	C3.8			
			<b>U903-01</b>	Adult ear clip, 1.1m	C5			











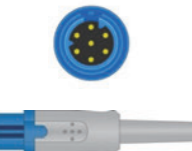

Dixon Next Page

OEM Manufacturer & Models	Sensor Connector	REF# OEM	REF# UNIMED	Sensor Descriptions	Price (unit)	Ext - Cable	Monitor end Conn.	Sensor end Conn.
<b>Dixon</b>								
DS3,DS5,DS7 (*M-Tech)	 20-pin connector, keyed		<b>U110-87</b>	Pediatric finger clip, 3.0m	D3	Direct		
			<b>U110S-87</b>	Pediatric soft tip, 3.0m	D3			
			<b>U210S-87</b>	Infant soft tip, 3.0m	D3			
			<b>U310-87</b>	Neonate wrap, 3.0m	D3			
			<b>U410-87</b>	Adult finger clip, 3.0m	D2			
			<b>U410S-87</b>	Adult soft tip, 3.0m	D3			
			<b>U610-87</b>	Adult/Neonate wrap, 3.0m	D2			
			<b>U610B-87</b>	Pediatric/Infant wrap, 3.0m	D2			
			<b>U810-87</b>	Multi-site, 3.0m	D2			
			<b>U910-87</b>	Adult ear clip, 3.0m	D3			
	 9-pin connector, Keyed	See M-Tech U*03-49R Series Sensor	2.2m		U708M-87			
Storm 5300,Storm 5500 Storm 5800,Storm 5900	 6-pin lemo connector, 2 notches, 40° keyed		<b>U110-29</b>	Pediatric finger clip, 3.0m	C7	Direct		
			<b>U110S-29</b>	Pediatric soft tip, 3.0m	C7			
			<b>U210S-29</b>	Infant soft tip, 3.0m	C7			
			<b>U310-29</b>	Neonate wrap, 3.0m	C7			
			<b>U410-29</b>	Adult finger clip, 3.0m	C5			
			<b>U410S-29</b>	Adult soft tip, 3.0m	C7			
			<b>U610-29</b>	Adult/Neonate wrap, 3.0m	C5			
			<b>U610B-29</b>	Pediatric/Infant wrap, 3.0m	C5			
			<b>U810-29</b>	Multi-site, 3.0m	C5			
			<b>U910-29</b>	Adult ear clip, 3.0m	C7			
	 9-pin connector, Keyed	See NE-Tech (OxiSmart) U*03-01 Series Sensor	2.2m		U708-29			
<b>Dixtal</b>								
DX 2010, DX 2020, DX 2021, DX 2022, DX 2023, DX 2025, DX 2405, DX 2515, DX 405, DX 7100, DX 7300, DX 8100	 7-pin connector, keyed		<b>U110-113</b>	Pediatric finger clip, 3.0m	C8	Direct		
			<b>U110S-113</b>	Pediatric soft tip, 3.0m	C8			
			<b>U210S-113</b>	Infant soft tip, 3.0m	C8			
			<b>U310-113</b>	Neonate wrap, 3.0m	C8			
			<b>U410-113</b>	Adult finger clip, 3.0m	C7			
			<b>U410S-113</b>	Adult soft tip, 3.0m	C8			
			<b>U610-113</b>	Adult/Neonate wrap, 3.0m	C7			
			<b>U610B-113</b>	Pediatric/Infant wrap, 3.0m	C7			
			<b>U810-113</b>	Multi-site, 3.0m	C7			
			<b>U910-113</b>	Adult ear clip, 3.0m	C8			
	 9-pin connector, Keyed	See NE-Tech (OxiSmart) U*03-01 Series Sensor	2.2m		U708-113			

OEM Manufacturer & Models	Sensor Connector	REF# OEM	REF# UNIMED	Sensor Descriptions	Price (unit)	Ext - Cable	Monitor end Conn.	Sensor end Conn.
<b>Dolphin</b>								
2100, 2150, 2G00751, ONE Oximeters 210	 9-pin connector, keyed		<b>U103-50D</b>	Pediatric finger clip, 1.1m	C8	Direct		
			<b>U103S-50D</b>	Pediatric soft tip, 1.1m	C8			
			<b>U203S-50D</b>	Infant soft tip, 1.1m	C8			
			<b>U303-50D</b>	Neonate wrap, 1.1m	C8			
		201	<b>U403-50D</b>	Adult finger clip, 1.1m	C7			
		360	<b>U403S-50D</b>	Adult soft tip, 1.1m	C8			
			<b>U603-50D</b>	Adult/Neonate wrap, 1.1m	C7			
			<b>U603B-50D</b>	Pediatric/Infant wrap, 1.1m	C7			
			<b>U803-50D</b>	Multi-site, 1.1m	C7			
			<b>U903-50D</b>	Adult ear clip, 1.1m	C8			
	 14-pin connector		<b>U110-50D</b>	Pediatric finger clip ,3.0m	D2	Direct		
			<b>U110S-50D</b>	Pediatric soft tip ,3.0m	D2			
			<b>U210S-50D</b>	Infant soft tip ,3.0m	D2			
			<b>U310-50D</b>	Neonate wrap ,3.0m	D2			
			<b>U410-50D</b>	Adult finger clip ,3.0m	D1			
			<b>U410S-50D</b>	Adult soft tip ,3.0m	D2			
			<b>U610-50D</b>	Adult/Neonate wrap ,3.0m	D1			
			<b>U610B-50D</b>	Pediatric/Infant wrap ,3.0m	D1			
			<b>U810-50D</b>	Multi-site ,3.0m	D1			
			<b>U910-50D</b>	Adult ear clip ,3.0m	D2			
<b>Draeger/Dräger &gt; Siemens</b>								
Oxipac 2000, Oxipac 2500 (*BCI Tech)	 9-pin connector		<b>U110-06</b>	Pediatric finger clip, 3.0m	C7	Direct		
			<b>U110S-06</b>	Pediatric soft tip, 3.0m	C7			
			<b>U210S-06</b>	Infant soft tip, 3.0m	C7			
			<b>U310-06</b>	Neonate wrap, 3.0m	C7			
			<b>U410-06</b>	Adult finger clip, 3.0m	C5			
			<b>U410S-06</b>	Adult soft tip, 3.0m	C7			
			<b>U610-06</b>	Adult/Neonate wrap, 3.0m	C5			
			<b>U610B-06</b>	Pediatric/Infant wrap, 3.0m	C5			
			<b>U810-06</b>	Multi-site, 3.0m	C5			
			<b>U910-06</b>	Adult ear clip, 3.0m	C7			
Vitalert 1000,Cicero,CATO VITARA,PM8014/8060	 9-pin connector, keyed		<b>U103-01</b>	Pediatric finger clip, 1.1m	C5	U708-28 (M35370, M35371)		
			<b>U103S-01</b>	Pediatric soft tip, 1.1m	C5			
			<b>U203S-01</b>	Infant soft tip, 1.1m	C5			
			<b>U303-01</b>	Neonate wrap, 1.1m	C5			
			<b>U403-01</b>	Adult finger clip, 1.1m	C3.8			
			<b>U403S-01</b>	Adult soft tip, 1.1m	C5			
			<b>U603-01</b>	Adult/Neonate wrap, 1.1m	C3.8			
			<b>U603B-01</b>	Pediatric/Infant wrap, 1.1m	C3.8			
			<b>U803-01</b>	Multi-site, 1.1m	C3.8			
			<b>U903-01</b>	Adult ear clip, 1.1m	C5			
Narkomed 4, VitAlert 3200	 9-pin connector, Keyed	See NE-Tech (OxiSmart) U*03-01 Series Sensor		3.0m		U710-85		

Draeger/Dräger > Siemens Next Page











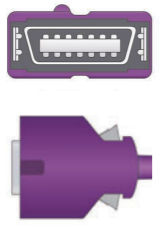

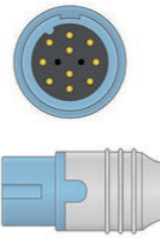

OEM Manufacturer & Models	Sensor Connector	REF# OEM	REF# UNIMED	Sensor Descriptions	Price (unit)	Ext - Cable	Monitor end Conn.	Sensor end Conn.
Draeger/Dräger > Siemens								
Sirecust 630, Sirecust 700, Sirem Module SpO2			<b>U110-33</b>	Pediatric finger clip, 3.0m	C8	Direct		
			<b>U110S-33</b>	Pediatric soft tip, 3.0m	C8			
			<b>U210S-33</b>	Infant soft tip, 3.0m	C8			
			<b>U310-33</b>	Neonate wrap, 3.0m	C8			
			<b>U410-33</b>	Adult finger clip, 3.0m	C7			
			<b>U410S-33</b>	Adult soft tip, 3.0m	C8			
			<b>U610-33</b>	Adult/Neonate wrap, 3.0m	C7			
			<b>U610B-33</b>	Pediatric/Infant wrap, 3.0m	C7			
			<b>U810-33</b>	Multi-site, 3.0m	C7			
			<b>U910-33</b>	Adult ear clip, 3.0m	C8			
		See NE-Tech (OxiSmart) U*03-01 Series Sensor	2.2m		U708-33			
Infinity Delta, Infinity Gamma, Infinity Kappa, Infinity MultiMed Pod, Infinity Vista, SC 6002XL, SC 7000, SC 8000, SC 9000XL			<b>U110-23</b>	Pediatric finger clip, 3.0m	C8	Direct		
			<b>U110S-23</b>	Pediatric soft tip, 3.0m	C8			
			<b>U210S-23</b>	Infant soft tip, 3.0m	C8			
			<b>U310-23</b>	Neonate wrap, 3.0m	C8			
			<b>U410-23</b>	Adult finger clip, 3.0m	C7			
			<b>U410S-23</b>	Adult soft tip, 3.0m	C8			
			<b>U610-23</b>	Adult/Neonate wrap, 3.0m	C7			
			<b>U610B-23</b>	Pediatric/Infant wrap, 3.0m	C7			
			<b>U810-23</b>	Multi-site, 3.0m	C7			
			<b>U910-23</b>	Adult ear clip, 3.0m	C8			
		See NE-Tech (OxiSmart) U*03-01 Series Sensor	2.2m		U708-23 (3375834)			
Infinity Delta/Delta XL/Kappa/Gamma XXL/Vista XL, Siemens SC7000/SC9000XL/SC 8000 (*NE-Tech OxiMax)			<b>U110-23P</b>	Pediatric finger clip, 3.0m	D2	Direct		
			<b>U110S-23P</b>	Pediatric soft tip, 3.0m	D2			
			<b>U210S-23P</b>	Infant soft tip, 3.0m	D2			
			<b>U310-23P</b>	Neonate wrap, 3.0m	D2			
			<b>U410-23P</b>	Adult finger clip, 3.0m	D1			
			<b>U410S-23P</b>	Adult soft tip, 3.0m	D2			
			<b>U610-23P</b>	Adult/Neonate wrap, 3.0m	D1			
			<b>U610B-23P</b>	Pediatric/Infant wrap, 3.0m	D1			
			<b>U810-23P</b>	Multi-site, 3.0m	D1			
			<b>U910-23P</b>	Adult ear clip, 3.0m	D2			
		See NE-Tech (OxiMax) U*03-01P Series Sensor	3.0m		U710X-23 (MS17330)			



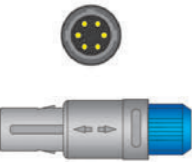







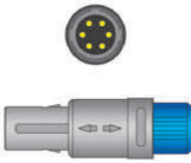

Draeger/Dräger > Siemens Next Page

OEM Manufacturer & Models	Sensor Connector	REF# OEM	REF# UNIMED	Sensor Descriptions	Price (unit)	Ext - Cable	Monitor end Conn.	Sensor end Conn.
Draeger/Dräger > Siemens								
Infinity Delta, Infinity Gamma, Infinity Kappa, Infinity MultiMed Pod, Infinity Vista (*M-Tech Rainbow)			<b>U110-23MR</b>	Pediatric finger clip, 3.0m	D1	Direct		
			<b>U110S-23MR</b>	Pediatric soft tip, 3.0m	D1			
			<b>U210S-23MR</b>	Infant soft tip, 3.0m	D1			
			<b>U310-23MR</b>	Neonate wrap, 3.0m	D1			
			<b>U410-23MR</b>	Adult finger clip, 3.0m	C8			
			<b>U410S-23MR</b>	Adult soft tip, 3.0m	D1			
			<b>U610-23MR</b>	Adult/Neonate wrap, 3.0m	C8			
			<b>U610B-23MR</b>	Pediatric/Infant wrap, 3.0m	C8			
			<b>U810-23MR</b>	Multi-site, 3.0m	C8			
			<b>U910-23MR</b>	Adult ear clip, 3.0m	D1			
Oxytrend Pulse Oximeter (*M-Tech)		MP00795	<b>U103-49R</b>	Pediatric finger clip, 1.1m	C8.1	U710M-23R (MS17522)		
			<b>U103S-49R</b>	Pediatric soft tip, 1.1m	C8.1			
			<b>U203S-49R</b>	Infant soft tip, 1.1m	C8.1			
			<b>U303-49R</b>	Neonate wrap, 1.1m	C8.1			
		MP00796	<b>U403-49R</b>	Adult finger clip, 1.1m	C6.7			
		MP02993	<b>U403S-49R</b>	Adult soft tip, 1.1m	C8.1			
			<b>U603-49R</b>	Adult/Neonate wrap, 1.1m	C6.7			
			<b>U603B-49R</b>	Pediatric/Infant wrap, 1.1m	C6.7			
		MP00789	<b>U803-49R</b>	Multi-site, 1.1m	C6.7			
		MP00788	<b>U903-49R</b>	Adult ear clip, 1.1m	C8.1			
Vista 120			<b>U110-15R</b>	Pediatric finger clip, 3.0m	D1	Direct		
			<b>U110S-15R</b>	Pediatric soft tip, 3.0m	D1			
			<b>U210S-15R</b>	Infant soft tip, 3.0m	D1			
			<b>U310-15R</b>	Neonate wrap, 3.0m	D1			
			<b>U410-15R</b>	Adult finger clip, 3.0m	C8			
			<b>U410S-15R</b>	Adult soft tip, 3.0m	D1			
			<b>U610-15R</b>	Adult/Neonate wrap, 3.0m	C8			
			<b>U610B-15R</b>	Pediatric/Infant wrap, 3.0m	C8			
			<b>U810-15R</b>	Multi-site, 3.0m	C8			
			<b>U910-15R</b>	Adult ear clip, 3.0m	D1			
		See M-Tech U*03-49R Series Sensor	2.2m		U708M-15R			
Vista 120			<b>U110-29</b>	Pediatric finger clip, 3.0m	C7	Direct		
			<b>U110S-29</b>	Pediatric soft tip, 3.0m	C7			
			<b>U210S-29</b>	Infant soft tip, 3.0m	C7			
			<b>U310-29</b>	Neonate wrap, 3.0m	C7			
		2606483/2606484	<b>U410-29</b>	Adult finger clip, 3.0m	C5			
			<b>U410S-29</b>	Adult soft tip, 3.0m	C7			
			<b>U610-29</b>	Adult/Neonate wrap, 3.0m	C5			
			<b>U610B-29</b>	Pediatric/Infant wrap, 3.0m	C5			
			<b>U810-29</b>	Multi-site, 3.0m	C5			
			<b>U910-29</b>	Adult ear clip, 3.0m	C7			
		See NE-Tech (OxiSmart) U*03-01 Series Sensor	2.2m		U708-29 (2606487)			

Draeger/Dräger > Siemens Next Page







OEM Manufacturer & Models	Sensor Connector	REF# OEM	REF# UNIMED	Sensor Descriptions	Price (unit)	Ext - Cable	Monitor end Conn.	Sensor end Conn.
Draeger/Dräger > Siemens								
Vista 120 with NE models (*NE-Tech OxiMax)	 14-pin connector		<b>U110-70P</b>	Pediatric finger clip, 3.0m	D2	Direct		
			<b>U110S-70P</b>	Pediatric soft tip, 3.0m	D2			
			<b>U210S-70P</b>	Infant soft tip, 3.0m	D2			
			<b>U310-70P</b>	Neonate wrap, 3.0m	D2			
			<b>U410-70P</b>	Adult finger clip, 3.0m	D1			
			<b>U410S-70P</b>	Adult soft tip, 3.0m	D2			
			<b>U610-70P</b>	Adult/Neonate wrap, 3.0m	D1			
			<b>U610B-70P</b>	Pediatric/Infant wrap, 3.0m	D1			
			<b>U810-70P</b>	Multi-site, 3.0m	D1			
			<b>U910-70P</b>	Adult ear clip, 3.0m	D2			
	 9-pin connector, Keyed	See NE-Tech (OxiSmart) U*03-01 Series Sensor	3.0m		U710-70 (MS20979)	 		
DRE								
Pro, Touch, Waveline EZ	 10-pin connector, keyed		<b>U110-213</b>	Pediatric finger clip, 3.0m	C8	Direct		
			<b>U110S-213</b>	Pediatric soft tip, 3.0m	C8			
			<b>U210S-213</b>	Infant soft tip, 3.0m	C8			
			<b>U310-213</b>	Neonate wrap, 3.0m	C8			
			<b>U410-213</b>	Adult finger clip, 3.0m	C7			
			<b>U410S-213</b>	Adult soft tip, 3.0m	C8			
			<b>U610-213</b>	Adult/Neonate wrap, 3.0m	C7			
			<b>U610B-213</b>	Pediatric/Infant wrap, 3.0m	C7			
			<b>U810-213</b>	Multi-site, 3.0m	C7			
			<b>U910-213</b>	Adult ear clip, 3.0m	C8			
	 9-pin connector, Keyed	See NE-Tech (OxiSmart) U*03-01 Series Sensor	2.2m		U708-213	 		
Waveline EZ MAX, Waveline Pro (*NE-Tech OxiMax)	 6-pin lemo connector, 1 notch		<b>U110-212P</b>	Pediatric finger clip, 3.0m	D1	Direct		
			<b>U110S-212P</b>	Pediatric soft tip, 3.0m	D1			
			<b>U210S-212P</b>	Infant soft tip, 3.0m	D1			
			<b>U310-212P</b>	Neonate wrap, 3.0m	D1			
			<b>U410-212P</b>	Adult finger clip, 3.0m	C8			
			<b>U410S-212P</b>	Adult soft tip, 3.0m	D1			
			<b>U610-212P</b>	Adult/Neonate wrap, 3.0m	C8			
			<b>U610B-212P</b>	Pediatric/Infant wrap, 3.0m	C8			
			<b>U810-212P</b>	Multi-site, 3.0m	C8			
			<b>U910-212P</b>	Adult ear clip, 3.0m	D1			
	 9-pin connector, Keyed	See NE-Tech (OxiMax) U*03-01P Series Sensor	3.0m		U710X-212	 		

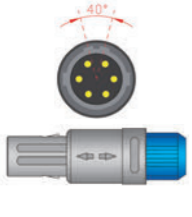

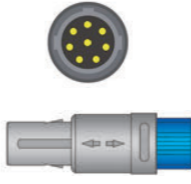



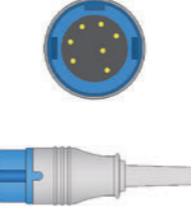
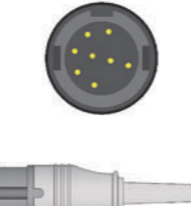

DRE Next Page

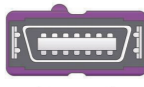
OEM Manufacturer & Models	Sensor Connector	REF# OEM	REF# UNIMED	Sensor Descriptions	Price (unit)	Ext - Cable	Monitor end Conn.	Sensor end Conn.
DRE								
Waveline, Waveline Pro	 6-pin lemo connector, 1 notch		<b>U110-137</b>	Pediatric finger clip, 3.0m	C8	Direct		
			<b>U110S-137</b>	Pediatric soft tip, 3.0m	C8			
			<b>U210S-137</b>	Infant soft tip, 3.0m	C8			
			<b>U310-137</b>	Neonate wrap, 3.0m	C8			
			<b>U410-137</b>	Adult finger clip, 3.0m	C7			
			<b>U410S-137</b>	Adult soft tip, 3.0m	C8			
			<b>U610-137</b>	Adult/Neonate wrap, 3.0m	C7			
			<b>U610B-137</b>	Pediatric/Infant wrap, 3.0m	C7			
			<b>U810-137</b>	Multi-site, 3.0m	C7			
			<b>U910-137</b>	Adult ear clip, 3.0m	C8			
	 9-pin connector, Keyed	See NE-Tech (OxiSmart) U*03-01 Series Sensor	2.2m		U708-137	 		
Waveline Pro+	 6-pin lemo connector, 1 notch		<b>U110-147</b>	Pediatric finger clip, 3.0m	C8	Direct		
			<b>U110S-147</b>	Pediatric soft tip, 3.0m	C8			
			<b>U210S-147</b>	Infant soft tip, 3.0m	C8			
			<b>U310-147</b>	Neonate wrap, 3.0m	C8			
			<b>U410-147</b>	Adult finger clip, 3.0m	C7			
			<b>U410S-147</b>	Adult soft tip, 3.0m	C8			
			<b>U610-147</b>	Adult/Neonate wrap, 3.0m	C7			
			<b>U610B-147</b>	Pediatric/Infant wrap, 3.0m	C7			
			<b>U810-147</b>	Multi-site, 3.0m	C7			
			<b>U910-147</b>	Adult ear clip, 3.0m	C8			
	 9-pin connector, Keyed	See NE-Tech (OxiSmart) U*03-01 Series Sensor	2.2m		U708-147	 		
Spectra AG5	 7-pin lemo connector, 1 notch		<b>U110-38</b>	Pediatric finger clip, 3.0m	C8	Direct		
			<b>U110S-38</b>	Pediatric soft tip, 3.0m	C8			
			<b>U210S-38</b>	Infant soft tip, 3.0m	C8			
			<b>U310-38</b>	Neonate wrap, 3.0m	C8			
			<b>U410-38</b>	Adult finger clip, 3.0m	C7			
			<b>U410S-38</b>	Adult soft tip, 3.0m	C8			
			<b>U610-38</b>	Adult/Neonate wrap, 3.0m	C7			
			<b>U610B-38</b>	Pediatric/Infant wrap, 3.0m	C7			
			<b>U810-38</b>	Multi-site, 3.0m	C7			
			<b>U910-38</b>	Adult ear clip, 3.0m	C8			
	 9-pin connector, Keyed	See NE-Tech (OxiSmart) U*03-01 Series Sensor	2.2m		U708-38	 		



OEM Manufacturer & Models	Sensor Connector	REF# OEM	REF# UNIMED	Sensor Descriptions	Price (unit)	Ext - Cable	Monitor end Conn.	Sensor end Conn.
DST								
DS5000A (*Digital Tech)	 6-pin lemo connector, 2 notches, 40° keyed	P02796	U110-65D	Pediatric finger clip, 3.0m	C8	Direct		
			U110S-65D	Pediatric soft tip, 3.0m	C8			
			U210S-65D	Infant soft tip, 3.0m	C8			
			U310-65D	Neonate wrap, 3.0m	C8			
			U410-65D	Adult finger clip, 3.0m	C7			
			U410S-65D	Adult soft tip, 3.0m	C8			
			U610-65D	Adult/Neonate wrap, 3.0m	C7			
			U610B-65D	Pediatric/Infant wrap, 3.0m	C7			
			U810-65D	Multi-site, 3.0m	C7			
			U910-65D	Adult ear clip, 3.0m	C8			
	 9-pin connector, Keyed	See Digital Tech U*03-42D Series Sensor		2.2m		U708-65	 	
Edan								
H100B	 9-pin connector, keyed		U103-01	Pediatric finger clip, 1.1m	C5	Direct		
			U103S-01	Pediatric soft tip, 1.1m	C5			
			U203S-01	Infant soft tip, 1.1m	C5			
			U303-01	Neonate wrap, 1.1m	C5			
			U403-01	Adult finger clip, 1.1m	C3.8			
			U403S-01	Adult soft tip, 1.1m	C5			
			U603-01	Adult/Neonate wrap, 1.1m	C3.8			
			U603B-01	Pediatric/Infant wrap, 1.1m	C3.8			
			U803-01	Multi-site, 1.1m	C3.8			
			U903-01	Adult ear clip, 1.1m	C5			
H100BH100N (*NE-Tech OxiMax)	 9-pin connector, keyed		U103-01P	Pediatric finger clip, 1.1m	C7	Direct		
			U103S-01P	Pediatric soft tip, 1.1m	C7			
			U203S-01P	Infant soft tip, 1.1m	C7			
			U303-01P	Neonate wrap, 1.1m	C7			
			U403-01P	Adult finger clip, 1.1m	C5			
			U403S-01P	Adult soft tip, 1.1m	C7			
			U603-01P	Adult/Neonate wrap, 1.1m	C5			
			U603B-01P	Pediatric/Infant wrap, 1.1m	C5			
			U803-01P	Multi-site, 1.1m	C5			
			U903-01P	Adult ear clip, 1.1m	C7			
M3A, M3B, M50, M8, M80, M8A, M8B, M9, M9A, iM50, iM60, iM70, iM8, iM80, iM8A, iM8B, iM9, iM9A	 6-pin lemo connector, 2 notches, 40° keyed	02.01.210119	U110-29	Pediatric finger clip, 3.0m	C7	Direct		
			U110S-29	Pediatric soft tip, 3.0m	C7			
			U210S-29	Infant soft tip, 3.0m	C7			
			U310-29	Neonate wrap, 3.0m	C7			
			U410-29	Adult finger clip, 3.0m	C5			
			U410S-29	Adult soft tip, 3.0m	C7			
			U610-29	Adult/Neonate wrap, 3.0m	C5			
			U610B-29	Pediatric/Infant wrap, 3.0m	C5			
			U810-29	Multi-site, 3.0m	C5			
			U910-29	Adult ear clip, 3.0m	C7			
	 9-pin connector, Keyed	See NE-Tech (OxiSmart) U*03-01 Series Sensor		2.2m		U708-29	 	

OEM Manufacturer & Models	Sensor Connector	REF# OEM	REF# UNIMED	Sensor Descriptions	Price (unit)	Ext - Cable	Monitor end Conn.	Sensor end Conn.
Edan								
M3A, M3B, M50, M8, M80, M8A, M8B, M9, M9A, iM50, iM60, iM70, iM8, iM80, iM8A, iM8B, iM9, iM9A (*NE-Tech OxiMax)	 8-pin lemo connector, 1 notch		U110-191P	Pediatric finger clip, 3.0m	C8	Direct		
			U110S-191P	Pediatric soft tip, 3.0m	C8			
			U210S-191P	Infant soft tip, 3.0m	C8			
			U310-191P	Neonate wrap, 3.0m	C8			
			U410-191P	Adult finger clip, 3.0m	C7			
			U410S-191P	Adult soft tip, 3.0m	C8			
			U610-191P	Adult/Neonate wrap, 3.0m	C7			
			U610B-191P	Pediatric/Infant wrap, 3.0m	C7			
			U810-191P	Multi-site, 3.0m	C7			
			U910-191P	Adult ear clip, 3.0m	C8			
	 9-pin connector, Keyed	See NE-Tech (OxiMax) U*03-01P Series Sensor		2.2m		U708X-191	 	
iT20, iM20, elite V5/V6/V8	 7-pin connector, keyed		U110-48	Pediatric finger clip, 3.0m	C7	Direct		
			U110S-48	Pediatric soft tip, 3.0m	C7			
			U210S-48	Infant soft tip, 3.0m	C7			
			U310-48	Neonate wrap, 3.0m	C7			
			U410-48	Adult finger clip, 3.0m	C5			
			U410S-48	Adult soft tip, 3.0m	C7			
			U610-48	Adult/Neonate wrap, 3.0m	C5			
			U610B-48	Pediatric/Infant wrap, 3.0m	C5			
			U810-48	Multi-site, 3.0m	C5			
			U910-48	Adult ear clip, 3.0m	C7			
iT20, iM20, elite V5/V6/V8 (*NE-Tech OxiMax)	 8-pin connector, keyed		U110-48P	Pediatric finger clip, 3.0m	C8	Direct		
			U110S-48P	Pediatric soft tip, 3.0m	C8			
			U210S-48P	Infant soft tip, 3.0m	C8			
			U310-48P	Neonate wrap, 3.0m	C8			
			U410-48P	Adult finger clip, 3.0m	C7			
			U410S-48P	Adult soft tip, 3.0m	C8			
			U610-48P	Adult/Neonate wrap, 3.0m	C7			
			U610B-48P	Pediatric/Infant wrap, 3.0m	C7			
			U810-48P	Multi-site, 3.0m	C7			
			U910-48P	Adult ear clip, 3.0m	C8			
iT20, iM20, elite V5/V6/V8 (*M-Tech)	 8-pin connector, keyed		U110-48MR	Pediatric finger clip, 3.0m	D1	Direct		
			U110S-48MR	Pediatric soft tip, 3.0m	D1			
			U210S-48MR	Infant soft tip, 3.0m	D1			
			U310-48MR	Neonate wrap, 3.0m	D1			
			U410-48MR	Adult finger clip, 3.0m	C8			
			U410S-48MR	Adult soft tip, 3.0m	D1			
			U610-48MR	Adult/Neonate wrap, 3.0m	C8			
			U610B-48MR	Pediatric/Infant wrap, 3.0m	C8			
			U810-48MR	Multi-site, 3.0m	C8			
			U910-48MR	Adult ear clip, 3.0m	D1			





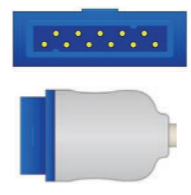
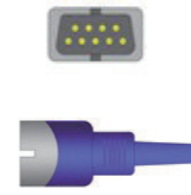
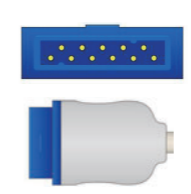
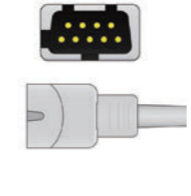
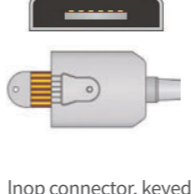



OEM Manufacturer & Models	Sensor Connector	REF# OEM	REF# UNIMED	Sensor Descriptions	Price (unit)	Ext - Cable	Monitor end Conn.	Sensor end Conn.
<b>Fukuda Denshi</b>								
Dynascope DS-7100-DS-7300 (*NE-Tech OxiMax)			<b>U110-70P</b>	Pediatric finger clip, 3.0m	D2	Direct		
			<b>U110S-70P</b>	Pediatric soft tip, 3.0m	D2			
			<b>U210S-70P</b>	Infant soft tip, 3.0m	D2			
			<b>U310-70P</b>	Neonate wrap, 3.0m	D2			
			<b>U410-70P</b>	Adult finger clip, 3.0m	D1			
			<b>U410S-70P</b>	Adult soft tip, 3.0m	D2			
			<b>U610-70P</b>	Adult/Neonate wrap, 3.0m	D1			
			<b>U610B-70P</b>	Pediatric/Infant wrap, 3.0m	D1			
			<b>U810-70P</b>	Multi-site, 3.0m	D1			
			<b>U910-70P</b>	Adult ear clip, 3.0m	D2			
		See NE-Tech (OxiMax) U*03-01P Series Sensor	3.0m			U710-70		
<b>Fiji</b>								
NLB7000N/8000B/8000 N NLB_V3,NBL_K3 LeFu: LF-6000A/6000B/6000C			<b>U110-134D</b>	Pediatric finger clip, 3.0m	D1	Direct		
			<b>U110S-134D</b>	Pediatric soft tip, 3.0m	D1			
			<b>U210S-134D</b>	Infant soft tip, 3.0m	D1			
			<b>U310-134D</b>	Neonate wrap, 3.0m	D1			
			<b>U410-134D</b>	Adult finger clip, 3.0m	C8			
			<b>U410S-134D</b>	Adult soft tip, 3.0m	D1			
			<b>U610-134D</b>	Adult/Neonate wrap, 3.0m	C8			
			<b>U610B-134D</b>	Pediatric/Infant wrap, 3.0m	C8			
			<b>U810-134D</b>	Multi-site, 3.0m	C8			
			<b>U910-134D</b>	Adult ear clip, 3.0m	D1			
		See Digital Tech U*03-42D Series Sensor	2.2m			U708-134		
<b>GE Healthcare &gt; Marquette</b>								
CARESCAPE Monitor B850 with Tram module 451/451N/851/851N CardioLab/Mac-Lab with Tram module 451/451N Corometrics 120/2120 Series Dash 3000/4000 (v5 or lower) with legacy Marquette option Dash 3000/4000/5000 with GE Ohmeda option Responder 3000 with Nellcor OxiSmart option Solar 8000/8000M/8000i and 9500 with Tram module 451/451N/851/851N			<b>U110-21</b>	Pediatric finger clip, 3.0m	D1	Direct		
			<b>U110S-21</b>	Pediatric soft tip, 3.0m	D1			
			<b>U210S-21</b>	Infant soft tip, 3.0m	D1			
			<b>U310-21</b>	Neonate wrap, 3.0m	D1			
			<b>U410-21</b>	Adult finger clip, 3.0m	C8			
			<b>U410S-21</b>	Adult soft tip, 3.0m	D1			
			<b>U610-21</b>	Adult/Neonate wrap, 3.0m	C8			
			<b>U610B-21</b>	Pediatric/Infant wrap, 3.0m	C8			
			<b>U810-21</b>	Multi-site, 3.0m	C8			
			<b>U910-21</b>	Adult ear clip, 3.0m	D1			
		See NE-Tech (OxiSmart) U*03-01 Series Sensor	3.0m			U710-21 (2006644-001)		

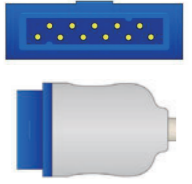



GE Healthcare > Marquette Next Page



OEM Manufacturer & Models	Sensor Connector	REF# OEM	REF# UNIMED	Sensor Descriptions	Price (unit)	Ext - Cable	Monitor end Conn.	Sensor end Conn.
<b>GE Healthcare &gt; Marquette</b>								
CARESCAPE Monitor B850 with CARESCAPE Patient Data Module option with Tram module 451N5/851N5 CARESCAPE Monitor B650 with CARESCAPE Patient Data Module option CARESCAPE V100 option CardioLab/Mac-Lab with Tram module 451N5 Dash 2500 option Dash 3000/4000/5000 with Solar 8000/8000M/8000i and 9500 with Tram module 451N5/851N5 Solar 8000M v5/8000i v5 with CARESCAPE Patient Data Module with E-NSATX module for S/5, AS/3, CS/3 modular monitors and CARESCAPE modular monitors with NE-Tech OxiMax option (*NE Tech OxiMax)			<b>U110-21P</b>	Pediatric finger clip, 3.0m	D2	Direct		
			<b>U110S-21P</b>	Pediatric soft tip, 3.0m	D2			
			<b>U210S-21P</b>	Infant soft tip, 3.0m	D2			
			<b>U310-21P</b>	Neonate wrap, 3.0m	D2			
			<b>U410-21P</b>	Adult finger clip, 3.0m	D1			
			<b>U410S-21P</b>	Adult soft tip, 3.0m	D2			
			<b>U610-21P</b>	Adult/Neonate wrap, 3.0m	D1			
			<b>U610B-21P</b>	Pediatric/Infant wrap, 3.0m	D1			
			<b>U810-21P</b>	Multi-site, 3.0m	D1			
			<b>U910-21P</b>	Adult ear clip, 3.0m	D2			
CARESCAPE V100 Corometrics 250 Series Dash 2500 Dash 3000/4000/5000 S/5, AS/3, CS/3 modular monitors with E-MASIMO module CardioLab/Mac-Lab with Tram module 451M CARESCAPE Monitor B850 with CARESCAPE Patient Data Module with E-MASIMO module with Masimo SpO2 module for Tram-Rac with Tram module 451M/851M CARESCAPE Monitor B650 with CARESCAPE Patient Data Module with E-MASIMO module Solar 8000M v5/8000i v5 with CARESCAPE Patient Data Module with Tram module 451M/851M Solar 8000/8000M/8000i with Masimo SpO2 module for Tram-Rac with Tram module 451M/851M Solar 9500 with Tram module 451M/851M PROCARE Monitor B40 PROCARE Monitor B20 with M-Tech option (*M-Tech Rainbow)			<b>U103-01P</b>	Pediatric finger clip, 1.1m	C7	U710X-21 (2021406-002)		
			<b>U103S-01P</b>	Pediatric soft tip, 1.1m	C7			
			<b>U203S-01P</b>	Infant soft tip, 1.1m	C7			
			<b>U303-01P</b>	Neonate wrap, 1.1m	C7			
			<b>U403-01P</b>	Adult finger clip, 1.1m	C5			
			<b>U403S-01P</b>	Adult soft tip, 1.1m	C7			
			<b>U603-01P</b>	Adult/Neonate wrap, 1.1m	C5			
			<b>U603B-01P</b>	Pediatric/Infant wrap, 1.1m	C5			
			<b>U803-01P</b>	Multi-site, 1.1m	C5			
			<b>U903-01P</b>	Adult ear clip, 1.1m	C7			
CARESCAPE V100 Corometrics 250 Series Dash 2500 Dash 3000/4000/5000 S/5, AS/3, CS/3 modular monitors with E-MASIMO module CardioLab/Mac-Lab with Tram module 451M CARESCAPE Monitor B850 with CARESCAPE Patient Data Module with E-MASIMO module with Masimo SpO2 module for Tram-Rac with Tram module 451M/851M CARESCAPE Monitor B650 with CARESCAPE Patient Data Module with E-MASIMO module Solar 8000M v5/8000i v5 with CARESCAPE Patient Data Module with Tram module 451M/851M Solar 8000/8000M/8000i with Masimo SpO2 module for Tram-Rac with Tram module 451M/851M Solar 9500 with Tram module 451M/851M PROCARE Monitor B40 PROCARE Monitor B20 with M-Tech option (*M-Tech Rainbow)			<b>U110-21MR</b>	Pediatric finger clip, 3.0m	D3	Direct		
			<b>U110S-21MR</b>	Pediatric soft tip, 3.0m	D3			
			<b>U210S-21MR</b>	Infant soft tip, 3.0m	D3			
			<b>U310-21MR</b>	Neonate wrap, 3.0m	D3			
			<b>U410-21MR</b>	Adult finger clip, 3.0m	D2			
			<b>U410S-21MR</b>	Adult soft tip, 3.0m	D3			
			<b>U610-21MR</b>	Adult/Neonate wrap, 3.0m	D2			
			<b>U610B-21MR</b>	Pediatric/Infant wrap, 3.0m	D2			
			<b>U810-21MR</b>	Multi-site, 3.0m	D2			
			<b>U910-21MR</b>	Adult ear clip, 3.0m	D3			
CARESCAPE Monitor B850 with Tram module 451/451N/851/851N CARESCAPE Monitor B650 with CARESCAPE Patient Data Module with E-MASIMO module Solar 8000M v5/8000i v5 with CARESCAPE Patient Data Module with Tram module 451M/851M Solar 8000/8000M/8000i with Masimo SpO2 module for Tram-Rac with Tram module 451M/851M Solar 9500 with Tram module 451M/851M PROCARE Monitor B40 PROCARE Monitor B20 with M-Tech option (*M-Tech Rainbow)			<b>U103-49R</b>	Pediatric finger clip, 1.1m	C8.1	U710M-21R (2027263-002)		
			<b>U103S-49R</b>	Pediatric soft tip, 1.1m	C8.1			
			<b>U203S-49R</b>	Infant soft tip, 1.1m	C8.1			
			<b>U303-49R</b>	Neonate wrap, 1.1m	C8.1			
			<b>U403-49R</b>	Adult finger clip, 1.1m	C6.7			
			<b>U403S-49R</b>	Adult soft tip, 1.1m	C8.1			
			<b>U603-49R</b>	Adult/Neonate wrap, 1.1m	C6.7			
			<b>U603B-49R</b>	Pediatric/Infant wrap, 1.1m	C6.7			
			<b>U803-49R</b>	Multi-site, 1.1m	C6.7			
			<b>U903-49R</b>	Adult ear clip, 1.1m	C8.1			
CARESCAPE Monitor B850 with Tram module 451/451N/851/851N CARESCAPE Monitor B650 with CARESCAPE Patient Data Module with E-MASIMO module Solar 8000M v5/8000i v5 with CARESCAPE Patient Data Module with Tram module 451M/851M Solar 8000/8000M/8000i with Masimo SpO2 module for Tram-Rac with Tram module 451M/851M Solar 9500 with Tram module 451M/851M PROCARE Monitor B40 PROCARE Monitor B20 with M-Tech option (*M-Tech Rainbow)			<b>U103-125R</b>	Pediatric finger clip, 1.1m	C8	U708M-21PR (2017002-003)		
			<b>U103S-125R</b>	Pediatric soft tip, 1.1m	C8			
			<b>U203S-125R</b>	Infant soft tip, 1.1m	C8			
			<b>U303-125R</b>	Neonate wrap, 1.1m	C8			
			<b>U403-125R</b>	Adult finger clip, 1.1m	C7			
			<b>U403S-125R</b>	Adult soft tip, 1.1m	C8			
			<b>U603-125R</b>	Adult/Neonate wrap, 1.1m	C7			
			<b>U603B-125R</b>	Pediatric/Infant wrap, 1.1m	C7			
			<b>U803-125R</b>	Multi-site, 1.1m	C7			
			<b>U903-125R</b>	Adult ear clip, 1.1m	C8			

GE Healthcare > Marquette Next Page

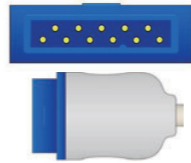







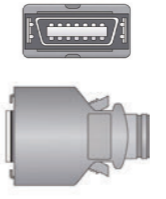

OEM Manufacturer & Models	Sensor Connector	REF# OEM	REF# UNIMED	Sensor Descriptions	Price (unit)	Ext - Cable	Monitor End Conn.	Sensor End Conn.
GE Healthcare > Marquette								
CARESCAPE modular monitors and S/5, AS/3 and CS/3 modular monitors with E-(P)RESTN or E-PSM(P) / E-PSMP modules. CARESCAPE V100 with TruSignal option, Responder, B20 and B40 monitors			<b>U110-121</b>	Pediatric finger clip, 3.0m	D2			
		TS-SP3-GE	<b>U110S-121</b>	Pediatric soft tip, 3.0m	D2			
			<b>U210S-121</b>	Infant soft tip, 3.0m	D2			
			<b>U310-121</b>	Neonate wrap, 3.0m	D2			
		TS-F4-GE	<b>U410-121</b>	Adult finger clip, 3.0m	D1	Direct		
		TS-SA4-GE	<b>U410S-121</b>	Adult soft tip, 3.0m	D2			
			<b>U610-121</b>	Adult/Neonate wrap, 3.0m	D1			
			<b>U610B-121</b>	Pediatric/Infant wrap, 3.0m	D1			
			<b>U810-121</b>	Multi-site, 3.0m	D1			
			TS-E4-GE	<b>U910-121</b>	Adult ear clip, 3.0m	D2		
		See GE TruSignal U*03-117 Series Sensor	3.0m			U710-111 (TS-G3)		
		See GE OxyTip+ U*03-127 Series Sensor	3.0m			U710-121 (OXY-ES3)		
7000 Series (*Ohmeda Tech) (Ohmeda Connector)		OXY-F4-H	<b>U110-02</b>	Pediatric finger clip, 3.0m	D1			
			<b>U110S-02</b>	Pediatric soft tip, 3.0m	D1			
			<b>U210S-02</b>	Infant soft tip, 3.0m	D1			
			<b>U310-02</b>	Neonate wrap, 3.0m	D1			
		TS-F4-H	<b>U410-02</b>	Adult finger clip, 3.0m	C8	Direct		
			<b>U410S-02</b>	Adult soft tip, 3.0m	D1			
		OXY-W4-H	<b>U610-02</b>	Adult/Neonate wrap, 3.0m	C8			
			<b>U610B-02</b>	Pediatric/Infant wrap, 3.0m	C8			
			<b>U810-02</b>	Multi-site, 3.0m	C8			
			TS-E4-H	<b>U910-02</b>	Adult ear clip, 3.0m	D1		
GE TruSignal/OxyTip+								
GE TruSignal (*TruSignal Tech)			<b>U103-117</b>	Pediatric finger clip, 1.1m	D1			
		TS-SP-D	<b>U103S-117</b>	Pediatric soft tip, 1.1m	D1			
			<b>U203S-117</b>	Infant soft tip, 1.1m	D1			
			<b>U303-117</b>	Neonate wrap, 1.1m	D1			
		TS-F-D	<b>U403-117</b>	Adult finger clip, 1.1m	C8	/		
		TS-SA-D	<b>U403S-117</b>	Adult soft tip, 1.1m	D1			
		TS-W-D	<b>U603-117</b>	Adult/Neonate wrap, 1.1m	C8			
		TS-SE-3	<b>U603B-117</b>	Pediatric/Infant wrap, 1.1m	C8			
			<b>U803-117</b>	Multi-site, 1.1m	C8			
			TS-E-D	<b>U903-117</b>	Adult ear clip, 1.1m	D1		
GE OxyTip+ (*TruSignal Tech)			<b>U103-127</b>	Pediatric finger clip, 1.1m	D1			
			<b>U103S-127</b>	Pediatric soft tip, 1.1m	D1			
			<b>U203S-127</b>	Infant soft tip, 1.1m	D1			
		6038-6000-039	<b>U303-127</b>	Neonate wrap, 1.1m	D1			
		OXY-F-UN	<b>U403-127</b>	Adult finger clip, 1.1m	C8	/		
		OXY-SA-UN	<b>U403S-127</b>	Adult soft tip, 1.1m	D1			
		OXY-W-UN	<b>U603-127</b>	Adult/Neonate wrap, 1.1m	C8			
			<b>U603B-127</b>	Pediatric/Infant wrap, 1.1m	C8			
			<b>U803-127</b>	Multi-site, 1.1m	C8			
			OXY-E-UN	<b>U903-127</b>	Adult ear clip, 1.1m	D1		

OEM Manufacturer & Models	Sensor Connector	REF# OEM	REF# UNIMED	Sensor Descriptions	Price (unit)	Ext - Cable	Monitor End Conn.	Sensor End Conn.
GE Healthcare > Corometrics								
120, 128, 129, 250, 250cx, 259			<b>U110-21</b>	Pediatric finger clip, 3.0m	D1			
			<b>U110S-21</b>	Pediatric soft tip, 3.0m	D1			
			<b>U210S-21</b>	Infant soft tip, 3.0m	D1			
			<b>U310-21</b>	Neonate wrap, 3.0m	D1			
			<b>U410-21</b>	Adult finger clip, 3.0m	C8	Direct		
			<b>U410S-21</b>	Adult soft tip, 3.0m	D1			
			<b>U610-21</b>	Adult/Neonate wrap, 3.0m	C8			
			<b>U610B-21</b>	Pediatric/Infant wrap, 3.0m	C8			
			<b>U810-21</b>	Multi-site, 3.0m	C8			
			<b>U910-21</b>	Adult ear clip, 3.0m	D1			
		See NE-Tech (OxiSmart) U*03-01 Series Sensor	3.0m			U710-21 (2006644-001)		
120,510,511,118,556			<b>U110-25</b>	Pediatric finger clip, 3.0m	C8			
			<b>U110S-25</b>	Pediatric soft tip, 3.0m	C8			
			<b>U210S-25</b>	Infant soft tip, 3.0m	C8			
			<b>U310-25</b>	Neonate wrap, 3.0m	C8			
			<b>U410-25</b>	Adult finger clip, 3.0m	C7	Direct		
			<b>U410S-25</b>	Adult soft tip, 3.0m	C8			
			<b>U610-25</b>	Adult/Neonate wrap, 3.0m	C7			
			<b>U610B-25</b>	Pediatric/Infant wrap, 3.0m	C7			
			<b>U810-25</b>	Multi-site, 3.0m	C7			
			<b>U910-25</b>	Adult ear clip, 3.0m	C8			
		See NE-Tech (OxiSmart) U*03-01 Series Sensor	3.0m			U710-25 (4033CAX)		
Corometrics® 250 Series option (*NE-Tech OxiMax)			<b>U110-21P</b>	Pediatric finger clip, 3.0m	D2			
			<b>U110S-21P</b>	Pediatric soft tip, 3.0m	D2			
			<b>U210S-21P</b>	Infant soft tip, 3.0m	D2			
			<b>U310-21P</b>	Neonate wrap, 3.0m	D2			
			<b>U410-21P</b>	Adult finger clip, 3.0m	D1	Direct		
			<b>U410S-21P</b>	Adult soft tip, 3.0m	D2			
			<b>U610-21P</b>	Adult/Neonate wrap, 3.0m	D1			
			<b>U610B-21P</b>	Pediatric/Infant wrap, 3.0m	D1			
			<b>U810-21P</b>	Multi-site, 3.0m	D1			
			<b>U910-21P</b>	Adult ear clip, 3.0m	D2			
		See NE-Tech (OxiMax) U*03-01P Series Sensor	3.0m			U710X-21		



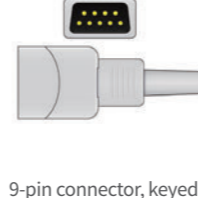









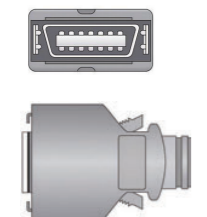

OEM Manufacturer & Models	Sensor Connector	REF# OEM	REF# UNIMED	Sensor Descriptions	Price (unit)	Ext - Cable	Monitor End Conn.	Sensor End Conn.
GE Healthcare > Critikon > Dinamap								
Dinamap 9700/9701 9702 PLUS, MPS ORTABLE, COMPACT			<b>U110-01</b>	Pediatric finger clip, 3.0m	C7	Direct		
			<b>U110S-01</b>	Pediatric soft tip, 3.0m	C7			
			<b>U210S-01</b>	Infant soft tip, 3.0m	C7			
			<b>U310-01</b>	Neonate wrap, 3.0m	C7			
			<b>U410-01</b>	Adult finger clip, 3.0m	C5			
			<b>U410S-01</b>	Adult soft tip, 3.0m	C7			
			<b>U610-01</b>	Adult/Neonate wrap, 3.0m	C5			
			<b>U610B-01</b>	Pediatric/Infant wrap, 3.0m	C5			
			<b>U810-01</b>	Multi-site, 3.0m	C5			
			<b>U910-01</b>	Adult ear clip, 3.0m	C7			
DINAMAP ProSeries V1 DINAMAP Pro 1000 V2			<b>U110-69</b>	Pediatric finger clip, 3.0m	D1	Direct		
			<b>U110S-69</b>	Pediatric soft tip, 3.0m	D1			
			<b>U210S-69</b>	Infant soft tip, 3.0m	D1			
			<b>U310-69</b>	Neonate wrap, 3.0m	D1			
			<b>U410-69</b>	Adult finger clip, 3.0m	C8			
			<b>U410S-69</b>	Adult soft tip, 3.0m	D1			
			<b>U610-69</b>	Adult/Neonate wrap, 3.0m	C8			
			<b>U610B-69</b>	Pediatric/Infant wrap, 3.0m	C8			
			<b>U810-69</b>	Multi-site, 3.0m	C8			
			<b>U910-69</b>	Adult ear clip, 3.0m	D1			
		See NE-Tech (OxiSmart) U*03-01 Series Sensor	3.0m		U710-69			
DINAMAP ProCare DINAMAP ProSeries V2 DINAMAP Pro 1000 V3 with NE-Tech OxiMax option ENSAT module for S/5, AS/3, CS/3 modular monitors and CARESCAPE modular monitors  (*NE-Tech OxiMax)			<b>U110-70P</b>	Pediatric finger clip, 3.0m	D2	Direct		
			<b>U110S-70P</b>	Pediatric soft tip, 3.0m	D2			
			<b>U210S-70P</b>	Infant soft tip, 3.0m	D2			
			<b>U310-70P</b>	Neonate wrap, 3.0m	D2			
			<b>U410-70P</b>	Adult finger clip, 3.0m	D1			
			<b>U410S-70P</b>	Adult soft tip, 3.0m	D2			
			<b>U610-70P</b>	Adult/Neonate wrap, 3.0m	D1			
			<b>U610B-70P</b>	Pediatric/Infant wrap, 3.0m	D1			
			<b>U810-70P</b>	Multi-site, 3.0m	D1			
			<b>U910-70P</b>	Adult ear clip, 3.0m	D2			
		See NE-Tech (OxiMax) U*03-01P Series Sensor	3.0m		U710-70 (2008773-001)			

GE Healthcare > Critikon > Dinamap Next Page



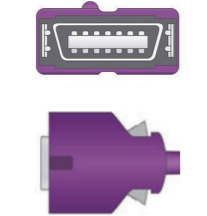



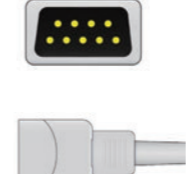

OEM Manufacturer & Models	Sensor Connector	REF# OEM	REF# UNIMED	Sensor Descriptions	Price (unit)	Ext - Cable	Monitor End Conn.	Sensor End Conn.
GE Healthcare > Critikon > Dinamap								
DINAMAP ProCare DINAMAP ProSeries V2 DINAMAP Pro 1000 V3 with M-Tech option (*M-Tech)			<b>U110-15R</b>	Pediatric finger clip, 3.0m	D1	Direct		
			<b>U110S-15R</b>	Pediatric soft tip, 3.0m	D1			
			<b>U210S-15R</b>	Infant soft tip, 3.0m	D1			
			<b>U310-15R</b>	Neonate wrap, 3.0m	D1			
			<b>U410-15R</b>	Adult finger clip, 3.0m	C8			
			<b>U410S-15R</b>	Adult soft tip, 3.0m	D1			
			<b>U610-15R</b>	Adult/Neonate wrap, 3.0m	C8			
			<b>U610B-15R</b>	Pediatric/Infant wrap, 3.0m	C8			
			<b>U810-15R</b>	Multi-site, 3.0m	C8			
			<b>U910-15R</b>	Adult ear clip, 3.0m	D1			
		See M-Tech U*03-49R Series Sensor	3.0m		U710M-15R (2027263-001)			
Dinamap 8700, Dinamap 8710, Dinamap 8720, Dinamap Pro, Dinamap Pro 8280, Dinamap Pro 9700, Dinamap Pro 9710, Oxyshuttle 1			<b>U110-10</b>	Pediatric finger clip, 3.0m	D1	Direct		
			<b>U110S-10</b>	Pediatric soft tip, 3.0m	D1			
			<b>U210S-10</b>	Infant soft tip, 3.0m	D1			
			<b>U310-10</b>	Neonate wrap, 3.0m	D1			
			<b>U410-10</b>	Adult finger clip, 3.0m	C8			
			<b>U410S-10</b>	Adult soft tip, 3.0m	D1			
			<b>U610-10</b>	Adult/Neonate wrap, 3.0m	C8			
			<b>U610B-10</b>	Pediatric/Infant wrap, 3.0m	C8			
			<b>U810-10</b>	Multi-site, 3.0m	C8			
			<b>U910-10</b>	Adult ear clip, 3.0m	D1			
GE Healthcare > Datex Ohmeda								
AS/3, AS/3 Compact, Aespire, Aespire 15, CG/2S, CH-RS, CH/2S, CH/S, CS/3, CS/5, CS/5 Compact, Capnomac Ultima, Cardiocap I, Cardiocap II, Cardiocap/5, Light Monitor, M-ESTP, M-NESTPR, M-PRESTN, OSP-200, Oscar II, Satellite, Satellite Plus II, Satellite Trans, System 5, Trans Plus, ULTS00, ULTSIO, ULTSVI, ULTSVO (*Datex Tech) (Datex Connector)			<b>U110-09</b>	Pediatric finger clip, 3.0m	C8	Direct		
			<b>U110S-09</b>	Pediatric soft tip, 3.0m	C8			
			<b>U210S-09</b>	Infant soft tip, 3.0m	C8			
			<b>U310-09</b>	Neonate wrap, 3.0m	C8			
			<b>U410-09</b>	Adult finger clip, 3.0m	C7			
			<b>U410S-09</b>	Adult soft tip, 3.0m	C8			
			<b>U610-09</b>	Adult/Neonate wrap, 3.0m	C7			
			<b>U610B-09</b>	Pediatric/Infant wrap, 3.0m	C7			
			<b>U810-09</b>	Multi-site, 3.0m	C7			
			<b>U910-09</b>	Adult ear clip, 3.0m	C8			
			<b>U103-09</b>	Pediatric finger clip, 1.1m	C5	U710-09 (OXY-C3)		
		<b>U103S-09</b>	Pediatric soft tip, 1.1m	C5				
		<b>U203S-09</b>	Infant soft tip, 1.1m	C5				
		<b>U303-09</b>	Neonate wrap, 1.1m	C5				
		<b>U403-09</b>	Adult finger clip, 1.1m	C3.8				
		<b>U403S-09</b>	Adult soft tip, 1.1m	C5				
		<b>U603-09</b>	Adult/Neonate wrap, 1.1m	C3.8				
		<b>U603B-09</b>	Pediatric/Infant wrap, 1.1m	C3.8				
		<b>U803-09</b>	Multi-site, 1.1m	C3.8				
		<b>U903-09</b>	Adult ear clip, 1.1m	C5				

GE Healthcare > Critikon > Dinamap Next Page













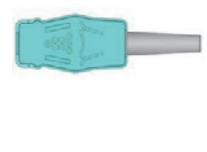
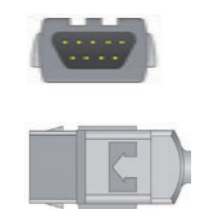
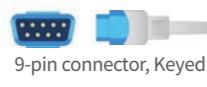



OEM Manufacturer & Models	Sensor Connector	REF# OEM	REF# UNIMED	Sensor Descriptions	Price (unit)	Ext - Cable	Monitor End Conn.	Sensor End Conn.
GE Healthcare > Datex Ohmeda								
CARESCAPE modular monitors and S/5, AS/3 and CS/3 modular monitors with M-NE12ST(P)R, M-(N)EST(P) (R) or M-(P)RESTN modules; Cardiocap/5 and S/5 Light Monitors (*TruSignal Tech) (Datex Connector)		See	GE TruSignal U*03-117 Series Sensor	3.0m		U710-119 (TS-N3)		
		See	GE OxyTip+ U*03-127 Series Sensor	3.0m		U710-209 (OXY-SL3)		
AS/3,CS/3,S/5 with M-NSAT Module		U110-69	Pediatric finger clip, 3.0m	D1	Direct			
		U110S-69	Pediatric soft tip, 3.0m	D1				
		U210S-69	Infant soft tip, 3.0m	D1				
		U310-69	Neonate wrap, 3.0m	D1				
		U410-69	Adult finger clip, 3.0m	C8				
		U410S-69	Adult soft tip, 3.0m	D1				
		U610-69	Adult/Neonate wrap, 3.0m	C8				
		U610B-69	Pediatric/Infant wrap, 3.0m	C8				
	U810-69	Multi-site, 3.0m	C8					
	U910-69	Adult ear clip, 3.0m	D1					
	See	NE-Tech (OxiSmart) U*03-01 Series Sensor	2.2m		U708-69			
i4 with M-NSAT module		U110-70P	Pediatric finger clip, 3.0m	D2	Direct			
		U110S-70P	Pediatric soft tip, 3.0m	D2				
		U210S-70P	Infant soft tip, 3.0m	D2				
		U310-70P	Neonate wrap, 3.0m	D2				
		U410-70P	Adult finger clip, 3.0m	D1				
		U410S-70P	Adult soft tip, 3.0m	D2				
		U610-70P	Adult/Neonate wrap, 3.0m	D1				
		U610B-70P	Pediatric/Infant wrap, 3.0m	D1				
	U810-70P	Multi-site, 3.0m	D1					
	U910-70P	Adult ear clip, 3.0m	D2					
	See	NE-Tech (OxiMax) U*03-01P Series Sensor	3.0m		U710-70			

GE Healthcare > Datex Ohmeda Next Page

OEM Manufacturer & Models	Sensor Connector	REF# OEM	REF# UNIMED	Sensor Descriptions	Price (unit)	Ext - Cable	Monitor End Conn.	Sensor End Conn.		
GE Healthcare > Datex Ohmeda										
Hand-held pulse oximeters (GE Ohmeda TuffSat*, 3775), tabletop pulse oximeters (3700 series, 3800, 3900, 3900P), respiratory gas monitors (4700, 5250 RGM), CARESCAPE modular monitors and S/5, AS/3, CS/3 modular monitors with M-OSAT module, Cardiocap*/5 with N-XOSAT option (*Ohmeda Tech) (Ohmeda Connector)		OXY-F4-H	U110-02	Pediatric finger clip, 3.0m	D1	Direct				
			U110S-02	Pediatric soft tip, 3.0m	D1					
			U210S-02	Infant soft tip, 3.0m	D1					
			U310-02	Neonate wrap, 3.0m	D1					
		TS-F4-H	U410-02	Adult finger clip, 3.0m	C8					
			U410S-02	Adult soft tip, 3.0m	D1					
		OXY-W4-H	U610-02	Adult/Neonate wrap, 3.0m	C8					
			U610B-02	Pediatric/Infant wrap, 3.0m	C8					
			U810-02	Multi-site, 3.0m	C8					
		TS-E4-H	U910-02	Adult ear clip, 3.0m	D1					
		U103-72	Pediatric finger clip, 1.1m	C7	U708-72					
		U103S-72	Pediatric soft tip, 1.1m	C7						
		U203S-72	Infant soft tip, 1.1m	C7						
		U303-72	Neonate wrap, 1.1m	C7						
		U403-72	Adult finger clip, 1.1m	C5						
U403S-72		Adult soft tip, 1.1m	C7							
U603-72		Adult/Neonate wrap, 1.1m	C5							
U603B-72	Pediatric/Infant wrap, 1.1m	C5								
U803-72	Multi-site, 1.1m	C5								
U903-72	Adult ear clip, 1.1m	C7								
	See	GE TruSignal U*03-117 Series Sensor	3.0m			U710-112 (TS-H3)				
		See	GE OxyTip+ U*03-127 Series Sensor	3.0m			U710-102 (OXY-OL3)			
Ohmeda TuffSat (*Ohmeda Tech) (Ohmeda Connector)		U103-02	Pediatric finger clip, 1.1m	C8		Direct				
		U103S-02	Pediatric soft tip, 1.1m	C8						
		U203S-02	Infant soft tip, 1.1m	C8						
		U303-02	Neonate wrap, 1.1m	C8						
		TS-F1-H	U403-02	Adult finger clip, 1.1m	C7					
			U403S-02	Adult soft tip, 1.1m	C8					
			U603-02	Adult/Neonate wrap, 1.1m	C7					
			U603B-02	Pediatric/Infant wrap, 1.1m	C7					
			U803-02	Multi-site, 1.1m	C7					
			U903-02	Adult ear clip, 1.1m	C8					

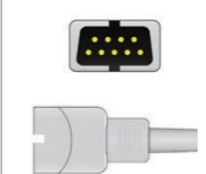
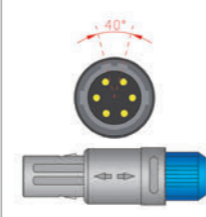







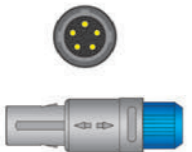

GE Healthcare > Datex Ohmeda Next Page









OEM Manufacturer & Models	Sensor Connector	REF# OEM	REF# UNIMED	Sensor Descriptions	Price (unit)	Ext - Cable	Monitor End Conn.	Sensor End Conn.
GE Healthcare > Datex Ohmeda								
Hand-held pulse oximeters (GE Ohmeda TuffSat*, 3775), tabletop pulse oximeters (3700 series, 3800, 3900, 3900P), respiratory gas monitors (4700, 5250 RGM), CARESCAPE modular monitors and S/5, AS/3, CS/3 modular monitors with M-OSAT module, Cardiocap*/5 with N-XOSAT option.			<b>U103-117</b>	Pediatric finger clip, 1.1m	D1	U710-112 (TS-H3)		
			<b>U103S-117</b>	Pediatric soft tip, 1.1m	D1			
			<b>U203S-117</b>	Infant soft tip, 1.1m	D1			
			<b>U303-117</b>	Neonate wrap, 1.1m	D1			
			<b>U403-117</b>	Adult finger clip, 1.1m	C8			
			<b>U403S-117</b>	Adult soft tip, 1.1m	D1			
			<b>U603-117</b>	Adult/Neonate wrap, 1.1m	C8			
			<b>U603B-117</b>	Pediatric/Infant wrap, 1.1m	C8			
			<b>U803-117</b>	Multi-site, 1.1m	C8			
			<b>U903-117</b>	Adult ear clip, 1.1m	D1			
(*TruSignal Tech) (Ohmeda Connector)			<b>U103-127</b>	Pediatric finger clip, 1.1m	D1	/		
			<b>U103S-127</b>	Pediatric soft tip, 1.1m	D1			
			<b>U203S-127</b>	Infant soft tip, 1.1m	D1			
			<b>U303-127</b>	Neonate wrap, 1.1m	D1			
			<b>U403-127</b>	Adult finger clip, 1.1m	C8			
			<b>U403S-127</b>	Adult soft tip, 1.1m	D1			
			<b>U603-127</b>	Adult/Neonate wrap, 1.1m	C8			
			<b>U603B-127</b>	Pediatric/Infant wrap, 1.1m	C8			
			<b>U803-127</b>	Multi-site, 1.1m	C8			
			<b>U903-127</b>	Adult ear clip, 1.1m	D1			
TruSat, TruSat ED, TruSat TD5			<b>U110-60</b>	Pediatric finger clip, 3.0m	D2	Direct		
		TS-SP3-MC	<b>U110S-60</b>	Pediatric soft tip, 3.0m	D2			
			<b>U210S-60</b>	Infant soft tip, 3.0m	D2			
			<b>U310-60</b>	Neonate wrap, 3.0m	D2			
		TS-F4-MC	<b>U410-60</b>	Adult finger clip, 3.0m	D1			
		TS-SA3-MC	<b>U410S-60</b>	Adult soft tip, 3.0m	D2			
		TS-W4-MC	<b>U610-60</b>	Adult/Neonate wrap, 3.0m	D1			
			<b>U610B-60</b>	Pediatric/Infant wrap, 3.0m	D1			
			<b>U810-60</b>	Multi-site, 3.0m	D1			
		TS-E4-MC	<b>U910-60</b>	Adult ear clip, 3.0m	D2			
(*TruSignal Tech)			See GE TruSignal U*03-117 Series Sensor	3.0m		U710-116 (TS-M3)		
			See GE OxyTip+ U*03-127 Series Sensor	3.0m		U710-160 (OXY-MC3)		





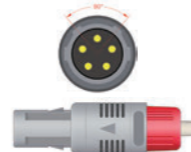



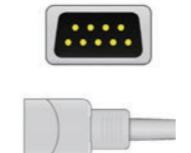

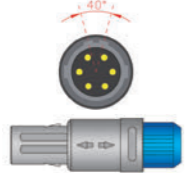

OEM Manufacturer & Models	Sensor Connector	REF# OEM	REF# UNIMED	Sensor Descriptions	Price (unit)	Ext - Cable	Monitor End Conn.	Sensor End Conn.
GE Healthcare > Hellige								
Cardioserv Eagle 1000-3000			<b>U110-55</b>	Pediatric finger clip, 3.0m	C8	Direct		
			<b>U110S-55</b>	Pediatric soft tip, 3.0m	C8			
			<b>U210S-55</b>	Infant soft tip, 3.0m	C8			
			<b>U310-55</b>	Neonate wrap, 3.0m	C8			
			<b>U410-55</b>	Adult finger clip, 3.0m	C7			
			<b>U410S-55</b>	Adult soft tip, 3.0m	C8			
			<b>U610-55</b>	Adult/Neonate wrap, 3.0m	C7			
			<b>U610B-55</b>	Pediatric/Infant wrap, 3.0m	C7			
			<b>U810-55</b>	Multi-site, 3.0m	C7			
			<b>U910-55</b>	Adult ear clip, 3.0m	C8			
		See NE-Tech (OxiSmart) U*03-01 Series Sensor	2.2m			U708-55 (30344358)		
General Meditech								
G1B,G1B,G2A,G3A,G3C,G3D			<b>U103-42D</b>	Pediatric finger clip, 1.1m	C7	Direct		
			<b>U103S-42D</b>	Pediatric soft tip, 1.1m	C7			
			<b>U203S-42D</b>	Infant soft tip, 1.1m	C7			
			<b>U303-42D</b>	Neonate wrap, 1.1m	C7			
		TS-F1-H	<b>U403-42D</b>	Adult finger clip, 1.1m	C5			
			<b>U403S-42D</b>	Adult soft tip, 1.1m	C7			
			<b>U603-42D</b>	Adult/Neonate wrap, 1.1m	C5			
			<b>U603B-42D</b>	Pediatric/Infant wrap, 1.1m	C5			
			<b>U803-42D</b>	Multi-site, 1.1m	C5			
			<b>U903-42D</b>	Adult ear clip, 1.1m	C7			
G2A,G3A,G3C,G3D,G3F,G3G,G3H,G3L,G6A,G6A plus, G9L			<b>U110-65D</b>	Pediatric finger clip, 3.0m	C8	Direct		
			<b>U110S-65D</b>	Pediatric soft tip, 3.0m	C8			
			<b>U210S-65D</b>	Infant soft tip, 3.0m	C8			
			<b>U310-65D</b>	Neonate wrap, 3.0m	C8			
			<b>U410-65D</b>	Adult finger clip, 3.0m	C7			
			<b>U410S-65D</b>	Adult soft tip, 3.0m	C8			
			<b>U610-65D</b>	Adult/Neonate wrap, 3.0m	C7			
			<b>U610B-65D</b>	Pediatric/Infant wrap, 3.0m	C7			
			<b>U810-65D</b>	Multi-site, 3.0m	C7			
			<b>U910-65D</b>	Adult ear clip, 3.0m	C8			
		See Digital Tech U*03-42D Series Sensor	2.2m			U708-65		

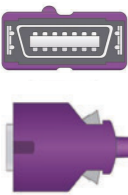









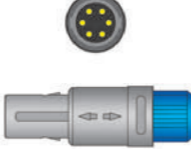

General Meditech Next Page



OEM Manufacturer & Models	Sensor Connector	REF# OEM	REF# UNIMED	Sensor Descriptions	Price (unit)	Ext - Cable	Monitor End Conn.	Sensor End Conn.
<b>General Meditech</b>								
G3D	 5-pin lemo connector, 1 notch		<b>U110-37</b>	Pediatric finger clip, 3.0m	C8	Direct		
			<b>U110S-37</b>	Pediatric soft tip, 3.0m	C8			
			<b>U210S-37</b>	Infant soft tip, 3.0m	C8			
			<b>U310-37</b>	Neonate wrap, 3.0m	C8			
			<b>U410-37</b>	Adult finger clip, 3.0m	C7			
			<b>U410S-37</b>	Adult soft tip, 3.0m	C8			
			<b>U610-37</b>	Adult/Neonate wrap, 3.0m	C7			
			<b>U610B-37</b>	Pediatric/Infant wrap, 3.0m	C7			
			<b>U810-37</b>	Multi-site, 3.0m	C7			
			<b>U910-37</b>	Adult ear clip, 3.0m	C8			
	 9-pin connector, Keyed	See NE-Tech (OxiSmart) U*03-01 Series Sensor	2.2m		U708-37	 		
<b>Generra</b>								
200, 300, 400, 530, 710, 810	 5-pin connector, 1 notch		<b>U110-39</b>	Pediatric finger clip, 3.0m	D2	Direct		
			<b>U110S-39</b>	Pediatric soft tip, 3.0m	D2			
			<b>U210S-39</b>	Infant soft tip, 3.0m	D2			
			<b>U310-39</b>	Neonate wrap, 3.0m	D2			
			<b>U410-39</b>	Adult finger clip, 3.0m	D1			
			<b>U410S-39</b>	Adult soft tip, 3.0m	D2			
			<b>U610-39</b>	Adult/Neonate wrap, 3.0m	D1			
			<b>U610B-39</b>	Pediatric/Infant wrap, 3.0m	D1			
			<b>U810-39</b>	Multi-site, 3.0m	D1			
			<b>U910-39</b>	Adult ear clip, 3.0m	D2			
<b>Guoteng</b>								
GT3000,GT5000 GT6000,GT7000 GT9000,GT9002	 6-pin lemo metal connector, 1 notch		<b>U110-171</b>	Pediatric finger clip, 3.0m	D1	Direct		
			<b>U110S-171</b>	Pediatric soft tip, 3.0m	D1			
			<b>U210S-171</b>	Infant soft tip, 3.0m	D1			
			<b>U310-171</b>	Neonate wrap, 3.0m	D1			
			<b>U410-171</b>	Adult finger clip, 3.0m	C8			
			<b>U410S-171</b>	Adult soft tip, 3.0m	D1			
			<b>U610-171</b>	Adult/Neonate wrap, 3.0m	C8			
			<b>U610B-171</b>	Pediatric/Infant wrap, 3.0m	C8			
			<b>U810-171</b>	Multi-site, 3.0m	C8			
			<b>U910-171</b>	Adult ear clip, 3.0m	D1			
	 6-pin lemo connector, 1 notch		<b>U110-179</b>	Pediatric finger clip, 3.0m	C8	Direct		
			<b>U110S-179</b>	Pediatric soft tip, 3.0m	C8			
			<b>U210S-179</b>	Infant soft tip, 3.0m	C8			
			<b>U310-179</b>	Neonate wrap, 3.0m	C8			
			<b>U410-179</b>	Adult finger clip, 3.0m	C7			
			<b>U410S-179</b>	Adult soft tip, 3.0m	C8			
			<b>U610-179</b>	Adult/Neonate wrap, 3.0m	C7			
			<b>U610B-179</b>	Pediatric/Infant wrap, 3.0m	C7			
			<b>U810-179</b>	Multi-site, 3.0m	C7			
			<b>U910-179</b>	Adult ear clip, 3.0m	C8			
	 9-pin connector, Keyed	See NE-Tech (OxiSmart) U*03-01 Series Sensor	2.2m		U708-179	 		











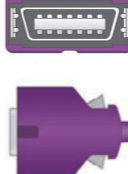





OEM Manufacturer & Models	Sensor Connector	REF# OEM	REF# UNIMED	Sensor Descriptions	Price (unit)	Ext - Cable	Monitor End Conn.	Sensor End Conn.
<b>Heal Force</b>								
Prince 180D	 5-pin lemo connector, 1 notch		<b>U110-37</b>	Pediatric finger clip, 3.0m	C8	Direct		
			<b>U110S-37</b>	Pediatric soft tip, 3.0m	C8			
			<b>U210S-37</b>	Infant soft tip, 3.0m	C8			
			<b>U310-37</b>	Neonate wrap, 3.0m	C8			
			<b>U410-37</b>	Adult finger clip, 3.0m	C7			
			<b>U410S-37</b>	Adult soft tip, 3.0m	C8			
			<b>U610-37</b>	Adult/Neonate wrap, 3.0m	C7			
			<b>U610B-37</b>	Pediatric/Infant wrap, 3.0m	C7			
			<b>U810-37</b>	Multi-site, 3.0m	C7			
			<b>U910-37</b>	Adult ear clip, 3.0m	C8			
	 9-pin connector, Keyed	See NE-Tech (OxiSmart) U*03-01 Series Sensor	2.2m		U708-37	 		
Classic 120, Prince 100F (*Digital Tech)	 5-pin lemo connector, 2 notches, 80° keyed		<b>U110-61D</b>	Pediatric finger clip, 3.0m	C8	Direct		
			<b>U110S-61D</b>	Pediatric soft tip, 3.0m	C8			
			<b>U210S-61D</b>	Infant soft tip, 3.0m	C8			
			<b>U310-61D</b>	Neonate wrap, 3.0m	C8			
			<b>U410-61D</b>	Adult finger clip, 3.0m	C7			
			<b>U410S-61D</b>	Adult soft tip, 3.0m	C8			
			<b>U610-61D</b>	Adult/Neonate wrap, 3.0m	C7			
			<b>U610B-61D</b>	Pediatric/Infant wrap, 3.0m	C7			
			<b>U810-61D</b>	Multi-site, 3.0m	C7			
			<b>U910-61D</b>	Adult ear clip, 3.0m	C8			
	 9-pin connector, Keyed	See Digital Tech U*03-42D Series Sensor	2.2m		U708-61	 		
<b>Healthdyne</b>								
930, 9705, 970S, 970SE  (*Nonin Tech)	 9-pin connector, keyed		<b>U110-08L</b>	Pediatric finger clip, 3.0m	C7	Direct		
			<b>U110S-08L</b>	Pediatric soft tip, 3.0m	C7			
			<b>U210S-08L</b>	Infant soft tip, 3.0m	C7			
			<b>U310-08L</b>	Neonate wrap, 3.0m	C7			
			<b>U410-08L</b>	Adult finger clip, 3.0m	C5			
			<b>U410S-08L</b>	Adult soft tip, 3.0m	C7			
			<b>U610-08L</b>	Adult/Neonate wrap, 3.0m	C5			
			<b>U610B-08L</b>	Pediatric/Infant wrap, 3.0m	C5			
			<b>U810-08L</b>	Multi-site, 3.0m	C5			
			<b>U910-08L</b>	Adult ear clip, 3.0m	C7			





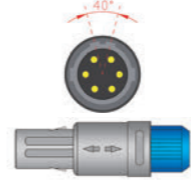
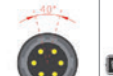

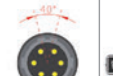



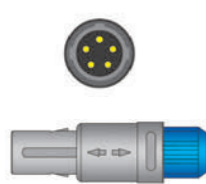

OEM Manufacturer & Models	Sensor Connector	REF# OEM	REF# UNIMED	Sensor Descriptions	Price (unit)	Ext - Cable	Monitor End Conn.	Sensor End Conn.
<b>HwaTime</b>								
PM-2000A Pro, PM1000F	 6-pin lemo connector, 2 notches, 40° keyed		<b>U110-175</b>	Pediatric finger clip, 3.0m	C8	Direct		
			<b>U110S-175</b>	Pediatric soft tip, 3.0m	C8			
			<b>U210S-175</b>	Infant soft tip, 3.0m	C8			
			<b>U310-175</b>	Neonate wrap, 3.0m	C8			
			<b>U410-175</b>	Adult finger clip, 3.0m	C7			
			<b>U410S-175</b>	Adult soft tip, 3.0m	C8			
			<b>U610-175</b>	Adult/Neonate wrap, 3.0m	C7			
			<b>U610B-175</b>	Pediatric/Infant wrap, 3.0m	C7			
			<b>U810-175</b>	Multi-site, 3.0m	C7			
			<b>U910-175</b>	Adult ear clip, 3.0m	C8			
	 9-pin connector, Keyed	See NE-Tech (OxiSmart) U*03-01 Series Sensor	2.2m		U708-175			
<b>Huntleigh</b>								
SC1200 with NE-Tech OxiMax option (*NE-Tech OxiMax)	 10-pin connector, keyed		<b>U110-70P</b>	Pediatric finger clip, 3.0m	D2	Direct		
			<b>U110S-70P</b>	Pediatric soft tip, 3.0m	D2			
			<b>U210S-70P</b>	Infant soft tip, 3.0m	D2			
			<b>U310-70P</b>	Neonate wrap, 3.0m	D2			
			<b>U410-70P</b>	Adult finger clip, 3.0m	D1			
			<b>U410S-70P</b>	Adult soft tip, 3.0m	D2			
			<b>U610-70P</b>	Adult/Neonate wrap, 3.0m	D1			
			<b>U610B-70P</b>	Pediatric/Infant wrap, 3.0m	D1			
			<b>U810-70P</b>	Multi-site, 3.0m	D1			
			<b>U910-70P</b>	Adult ear clip, 3.0m	D2			
	 9-pin connector, Keyed	See NE-Tech (OxiMax) U*03-01P Series Sensor	3.0m		U710-70 (320325-1)			
<b>Infinium</b>								
Omni, Omni II (*Digital Tech)	 5-pin lemo connector, 2 notches, 40° keyed		<b>U110-97D</b>	Pediatric finger clip, 3.0m	D1	Direct		
			<b>U110S-97D</b>	Pediatric soft tip, 3.0m	D1			
			<b>U210S-97D</b>	Infant soft tip, 3.0m	D1			
			<b>U310-97D</b>	Neonate wrap, 3.0m	D1			
			<b>U410-97D</b>	Adult finger clip, 3.0m	C8			
			<b>U410S-97D</b>	Adult soft tip, 3.0m	D1			
			<b>U610-97D</b>	Adult/Neonate wrap, 3.0m	C8			
			<b>U610B-97D</b>	Pediatric/Infant wrap, 3.0m	C8			
			<b>U810-97D</b>	Multi-site, 3.0m	C8			
			<b>U910-97D</b>	Adult ear clip, 3.0m	D1			
	 9-pin connector, Keyed	See Digital Tech U*03-42D Series Sensor	2.2m		U708-97			

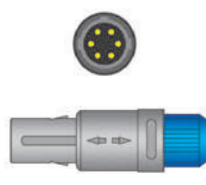
OEM Manufacturer & Models	Sensor Connector	REF# OEM	REF# UNIMED	Sensor Descriptions	Price (unit)	Ext - Cable	Monitor End Conn.	Sensor End Conn.
<b>Infinium</b>								
Omni (*Digital Tech)	 6-pin lemo connector, 1 notch		<b>U110-137D</b>	Pediatric finger clip, 3.0m	D1	Direct		
			<b>U110S-137D</b>	Pediatric soft tip, 3.0m	D1			
			<b>U210S-137D</b>	Infant soft tip, 3.0m	D1			
			<b>U310-137D</b>	Neonate wrap, 3.0m	D1			
			<b>U410-137D</b>	Adult finger clip, 3.0m	C8			
			<b>U410S-137D</b>	Adult soft tip, 3.0m	D1			
			<b>U610-137D</b>	Adult/Neonate wrap, 3.0m	C8			
			<b>U610B-137D</b>	Pediatric/Infant wrap, 3.0m	C8			
			<b>U810-137D</b>	Multi-site, 3.0m	C8			
			<b>U910-137D</b>	Adult ear clip, 3.0m	D1			
	 9-pin connector, Keyed	See Digital Tech U*03-42D Series Sensor	2.2m		U708-137			
Omni	 6-pin lemo connector, 2 notches, 40° keyed		<b>U110-147</b>	Pediatric finger clip, 3.0m	C8	Direct		
			<b>U110S-147</b>	Pediatric soft tip, 3.0m	C8			
			<b>U210S-147</b>	Infant soft tip, 3.0m	C8			
			<b>U310-147</b>	Neonate wrap, 3.0m	C8			
			<b>U410-147</b>	Adult finger clip, 3.0m	C7			
			<b>U410S-147</b>	Adult soft tip, 3.0m	C8			
			<b>U610-147</b>	Adult/Neonate wrap, 3.0m	C7			
			<b>U610B-147</b>	Pediatric/Infant wrap, 3.0m	C7			
			<b>U810-147</b>	Multi-site, 3.0m	C7			
			<b>U910-147</b>	Adult ear clip, 3.0m	C8			
	 9-pin connector, Keyed	See NE-Tech (OxiSmart) U*03-01 Series Sensor	2.2m		U708-147			
<b>Innocare</b>								
VET-Multi-Parameter	 7-pin lemo connector, 2 notches, 40° keyed		<b>U110-204</b>	Pediatric finger clip, 3.0m	C8	Direct		
			<b>U110S-204</b>	Pediatric soft tip, 3.0m	C8			
			<b>U210S-204</b>	Infant soft tip, 3.0m	C8			
			<b>U310-204</b>	Neonate wrap, 3.0m	C8			
			<b>U410-204</b>	Adult finger clip, 3.0m	C7			
			<b>U410S-204</b>	Adult soft tip, 3.0m	C8			
			<b>U610-204</b>	Adult/Neonate wrap, 3.0m	C7			
			<b>U610B-204</b>	Pediatric/Infant wrap, 3.0m	C7			
			<b>U810-204</b>	Multi-site, 3.0m	C7			
			<b>U910-204</b>	Adult ear clip, 3.0m	C8			
	 9-pin connector, Keyed	See NE-Tech (OxiSmart) U*03-01 Series Sensor	2.2m		U708-204			

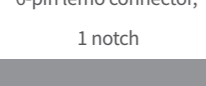
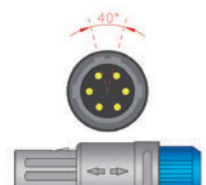

OEM Manufacturer & Models	Sensor Connector	REF# OEM	REF# UNIMED	Sensor Descriptions	Price (unit)	Ext - Cable	Monitor End Conn.	Sensor End Conn.
<b>Invivo</b>								
4500, 4500 Plus, Millennia, Omega 1445, Omni-Trak TVS, Sat Scout	 7-pin metal lemo connector	9383	U110-14	Pediatric finger clip, 3.0m	D1	Direct		
			U110S-14	Pediatric soft tip, 3.0m	D1			
			U210S-14	Infant soft tip, 3.0m	D1			
			U310-14	Neonate wrap, 3.0m	D1			
			U410-14	Adult finger clip, 3.0m	C8			
			U410S-14	Adult soft tip, 3.0m	D1			
			U610-14	Adult/Neonate wrap, 3.0m	C8			
			U610B-14	Pediatric/Infant wrap, 3.0m	C8			
			U810-14	Multi-site, 3.0m	C8			
			U910-14	Adult ear clip, 3.0m	D1			
	 9-pin connector, Keyed	See NE-Tech (OxiSmart) U*03-01 Series Sensor	2.2m		U708-14			
4500, 4500 Plus, Millennia, Omega 1445, Omni-Trak TVS, Sat Scout	 7-pin metal lemo connector		U110-14M	Pediatric finger clip, 3.0m	D1	Direct		
			U110S-14M	Pediatric soft tip, 3.0m	D1			
			U210S-14M	Infant soft tip, 3.0m	D1			
			U310-14M	Neonate wrap, 3.0m	D1			
			U410-14M	Adult finger clip, 3.0m	C8			
			U410S-14M	Adult soft tip, 3.0m	D1			
			U610-14M	Adult/Neonate wrap, 3.0m	C8			
			U610B-14M	Pediatric/Infant wrap, 3.0m	C8			
			U810-14M	Multi-site, 3.0m	C8			
			U910-14M	Adult ear clip, 3.0m	D1			
	 9-pin connector, Keyed	See M-Tech U*03-49R Series Sensor	2.2m		U708M-14			
<b>Ivy Biomedical</b>								
405A,405D	 9-pin connector, Keyed	See NE-Tech (OxiSmart) U*03-01 Series Sensor	3.0m		U710-85			
405A,405D	 9-pin connector, Keyed	See NE-Tech (OxiSmart) U*03-01 Series Sensor	1.1m		Direct			
Vital-Guard 450CN(M) (*M-Tech)	 14-pin connector		U110-15R	Pediatric finger clip, 3.0m	D1	Direct		
			U110S-15R	Pediatric soft tip, 3.0m	D1			
			U210S-15R	Infant soft tip, 3.0m	D1			
			U310-15R	Neonate wrap, 3.0m	D1			
			U410-15R	Adult finger clip, 3.0m	C8			
			U410S-15R	Adult soft tip, 3.0m	D1			
			U610-15R	Adult/Neonate wrap, 3.0m	C8			
			U610B-15R	Pediatric/Infant wrap, 3.0m	C8			
			U810-15R	Multi-site, 3.0m	C8			
			U910-15R	Adult ear clip, 3.0m	D1			
	 9-pin connector, Keyed	See M-Tech U*03-49R Series Sensor	2.2m		U708M-15R			







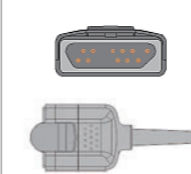

OEM Manufacturer & Models	Sensor Connector	REF# OEM	REF# UNIMED	Sensor Descriptions	Price (unit)	Ext - Cable	Monitor End Conn.	Sensor End Conn.
<b>Ivy Biomedical</b>								
450C,CM5 (*NE-Tech OxiMax)	 14-pin connector		U110-70P	Pediatric finger clip, 3.0m	D2	Direct		
			U110S-70P	Pediatric soft tip, 3.0m	D2			
			U210S-70P	Infant soft tip, 3.0m	D2			
			U310-70P	Neonate wrap, 3.0m	D2			
			U410-70P	Adult finger clip, 3.0m	D1			
			U410S-70P	Adult soft tip, 3.0m	D2			
			U610-70P	Adult/Neonate wrap, 3.0m	D1			
			U610B-70P	Pediatric/Infant wrap, 3.0m	D1			
			U810-70P	Multi-site, 3.0m	D1			
			U910-70P	Adult ear clip, 3.0m	D2			
	 9-pin connector, Keyed	See NE-Tech (OxiMax) U*03-01P Series Sensor	2.2m		U708-70			
<b>IBIO R&amp;DT</b>								
RD9015 RD9012 RD9010 RD9008	 5-pin lemo connector, 1 notch		U110-100	Pediatric finger clip, 3.0m	C8	Direct		
			U110S-100	Pediatric soft tip, 3.0m	C8			
			U210S-100	Infant soft tip, 3.0m	C8			
			U310-100	Neonate wrap, 3.0m	C8			
			U410-100	Adult finger clip, 3.0m	C7			
			U410S-100	Adult soft tip, 3.0m	C8			
			U610-100	Adult/Neonate wrap, 3.0m	C7			
			U610B-100	Pediatric/Infant wrap, 3.0m	C7			
			U810-100	Multi-site, 3.0m	C7			
			U910-100	Adult ear clip, 3.0m	C8			
	 9-pin connector, Keyed	See NE-Tech (OxiSmart) U*03-01 Series Sensor	2.2m		U708-100			
<b>Jeteem</b>								
BD-6000, BD-9000	 6-pin lemo connector, 2 notches, 40° keyed		U110-174	Pediatric finger clip, 3.0m	C8	Direct		
			U110S-174	Pediatric soft tip, 3.0m	C8			
			U210S-174	Infant soft tip, 3.0m	C8			
			U310-174	Neonate wrap, 3.0m	C8			
			U410-174	Adult finger clip, 3.0m	C7			
			U410S-174	Adult soft tip, 3.0m	C8			
			U610-174	Adult/Neonate wrap, 3.0m	C7			
			U610B-174	Pediatric/Infant wrap, 3.0m	C7			
			U810-174	Multi-site, 3.0m	C7			
			U910-174	Adult ear clip, 3.0m	C8			
	 9-pin connector, Keyed	See NE-Tech (OxiSmart) U*03-01 Series Sensor	2.2m		U708-174			

OEM Manufacturer & Models	Sensor Connector	REF# OEM	REF# UNIMED	Sensor Descriptions	Price (unit)	Ext - Cable	Monitor End Conn.	Sensor End Conn.
<b>Jumbor</b>								
JB9101/9105/9107	 5-pin lemo connector, 1 notch		<b>U110-37</b>	Pediatric finger clip, 3.0m	C8	Direct		
			<b>U110S-37</b>	Pediatric soft tip, 3.0m	C8			
			<b>U210S-37</b>	Infant soft tip, 3.0m	C8			
			<b>U310-37</b>	Neonate wrap, 3.0m	C8			
			<b>U410-37</b>	Adult finger clip, 3.0m	C7			
			<b>U410S-37</b>	Adult soft tip, 3.0m	C8			
			<b>U610-37</b>	Adult/Neonate wrap, 3.0m	C7			
			<b>U610B-37</b>	Pediatric/Infant wrap, 3.0m	C7			
			<b>U810-37</b>	Multi-site, 3.0m	C7			
			<b>U910-37</b>	Adult ear clip, 3.0m	C8			
	 9-pin connector, Keyed	See NE-Tech (OxiSmart) U*03-01 Series Sensor	2.2m		U708-37			
<b>Kernel</b>								
KN-601C	 6-pin lemo connector, 1 notch		<b>U110-222</b>	Pediatric finger clip , 3.0m	<b>C8.1</b>	Direct		
			<b>U110S-222</b>	Pediatric soft tip , 3.0m	<b>C8.1</b>			
			<b>U210S-222</b>	Infant soft tip , 3.0m	<b>C8.1</b>			
			<b>U310-222</b>	Neonate wrap , 3.0m	<b>C8.1</b>			
			<b>U410-222</b>	Adult finger clip , 3.0m	<b>C6.7</b>			
			<b>U410S-222</b>	Adult soft tip , 3.0m	<b>C8.1</b>			
			<b>U610-222</b>	Adult/Neonate wrap , 3.0m	<b>C6.7</b>			
			<b>U610B-222</b>	Pediatric/Infant wrap , 3.0m	<b>C6.7</b>			
			<b>U810-222</b>	Multi-site , 3.0m	<b>C6.7</b>			
			<b>U910-222</b>	Adult ear clip , 3.0m	<b>C8.1</b>			
	 9-pin connector, Keyed	See NE-Tech (OxiSmart) U*03-01 Series Sensor	2.2m		U708-37			
<b>Kontron</b>								
7138, 7840, 7845	 6-pin lemo connector, 2 notches, 40° keyed		<b>U110-29</b>	Pediatric finger clip, 3.0m	C7	Direct		
			<b>U110S-29</b>	Pediatric soft tip, 3.0m	C7			
			<b>U210S-29</b>	Infant soft tip, 3.0m	C7			
			<b>U310-29</b>	Neonate wrap, 3.0m	C7			
			<b>U410-29</b>	Adult finger clip, 3.0m	C5			
			<b>U410S-29</b>	Adult soft tip, 3.0m	C7			
			<b>U610-29</b>	Adult/Neonate wrap, 3.0m	C5			
			<b>U610B-29</b>	Pediatric/Infant wrap, 3.0m	C5			
			<b>U810-29</b>	Multi-site, 3.0m	C5			
			<b>U910-29</b>	Adult ear clip, 3.0m	C7			
	 9-pin connector, Keyed	See NE-Tech (OxiSmart) U*03-01 Series Sensor	2.2m		U708-29			
7150, 7850	 9-pin connector, keyed		<b>U110-01</b>	Pediatric finger clip, 3.0m	C7	Direct		
			<b>U110S-01</b>	Pediatric soft tip, 3.0m	C7			
			<b>U210S-01</b>	Infant soft tip, 3.0m	C7			
			<b>U310-01</b>	Neonate wrap, 3.0m	C7			
			<b>U410-01</b>	Adult finger clip, 3.0m	C5			
			<b>U410S-01</b>	Adult soft tip, 3.0m	C7			
			<b>U610-01</b>	Adult/Neonate wrap, 3.0m	C5			
			<b>U610B-01</b>	Pediatric/Infant wrap, 3.0m	C5			
			<b>U810-01</b>	Multi-site, 3.0m	C5			
			<b>U910-01</b>	Adult ear clip, 3.0m	C7			

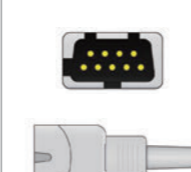
OEM Manufacturer & Models	Sensor Connector	REF# OEM	REF# UNIMED	Sensor Descriptions	Price (unit)	Ext - Cable	Monitor End Conn.	Sensor End Conn.
<b>Kontron</b>								
	 7-pin lemo connector, 2 notches, 80° keyed		<b>U110-53</b>	Pediatric finger clip, 3.0m	C8	Direct		
			<b>U110S-53</b>	Pediatric soft tip, 3.0m	C8			
			<b>U210S-53</b>	Infant soft tip, 3.0m	C8			
			<b>U310-53</b>	Neonate wrap, 3.0m	C8			
			<b>U410-53</b>	Adult finger clip, 3.0m	C7			
			<b>U410S-53</b>	Adult soft tip, 3.0m	C8			
			<b>U610-53</b>	Adult/Neonate wrap, 3.0m	C7			
			<b>U610B-53</b>	Pediatric/Infant wrap, 3.0m	C7			
			<b>U810-53</b>	Multi-site, 3.0m	C7			
			<b>U910-53</b>	Adult ear clip, 3.0m	C8			
	 9-pin connector, Keyed	See NE-Tech (OxiSmart) U*03-01 Series Sensor	2.2m		U708-53			
7138, 7840, 7845, Kolomon, Micromon, Minimon 7137, Supermon, Trakmon	 6-pin connector, keyed		<b>U110-13</b>	Pediatric finger clip, 3.0m	C8	Direct		
			<b>U110S-13</b>	Pediatric soft tip, 3.0m	C8			
			<b>U210S-13</b>	Infant soft tip, 3.0m	C8			
			<b>U310-13</b>	Neonate wrap, 3.0m	C8			
			<b>U410-13</b>	Adult finger clip, 3.0m	C7			
			<b>U410S-13</b>	Adult soft tip, 3.0m	C8			
			<b>U610-13</b>	Adult/Neonate wrap, 3.0m	C7			
			<b>U610B-13</b>	Pediatric/Infant wrap, 3.0m	C7			
			<b>U810-13</b>	Multi-site, 3.0m	C7			
			<b>U910-13</b>	Adult ear clip, 3.0m	C8			
	 9-pin connector, Keyed	See NE-Tech (OxiSmart) U*03-01 Series Sensor	2.2m		U708-13			
<b>Konica Minolta</b>								
Probe SP5C, Portable Pulsox-300, Pulsox-300i	 6-pin connector, Keyed		<b>U103-105</b>	Pediatric finger clip , 1.1m	C7	Direct		
			<b>U103S-105</b>	Pediatric soft tip , 1.1m	C7			
			<b>U203S-105</b>	Infant soft tip , 1.1m	C7			
			<b>U303-105</b>	Neonate wrap , 1.1m	C7			
			<b>U403-105</b>	Adult finger clip , 1.1m	C5			
			<b>U403S-105</b>	Adult soft tip , 1.1m	C7			
			<b>U603-105</b>	Adult/Neonate wrap , 1.1m	C5			
			<b>U603B-105</b>	Pediatric/Infant wrap , 1.1m	C5			
			<b>U803-105</b>	Multi-site , 1.1m	C5			
			<b>U903-105</b>	Adult ear clip , 1.1m	C7			
	 9-pin connector, Keyed	SR-5C						
<b>Konsung Medical</b>								
Aurora 8/10/12	 12-pin connector, Keyed		<b>U110-262</b>	Pediatric finger clip, 3.0m	<b>C6.7</b>	Direct		
			<b>U110S-262</b>	Pediatric soft tip, 3.0m	<b>C6.7</b>			
			<b>U210S-262</b>	Infant soft tip, 3.0m	<b>C6.7</b>			
			<b>U310-262</b>	Neonate wrap, 3.0m	<b>C6.7</b>			
			<b>U410-262</b>	Adult finger clip, 3.0m	<b>C5</b>			
			<b>U410S-262</b>	Adult soft tip, 3.0m	<b>C6.7</b>			
			<b>U610-262</b>	Adult/Neonate wrap, 3.0m	<b>C5</b>			
			<b>U610B-262</b>	Pediatric/Infant wrap, 3.0m	<b>C5</b>			
			<b>U810-262</b>	Multi-site, 3.0m	<b>C5</b>			
			<b>U910-262</b>	Adult ear clip, 3.0m	<b>C6.7</b>			

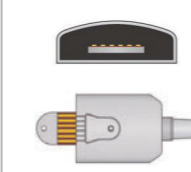
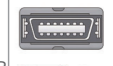

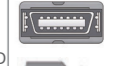





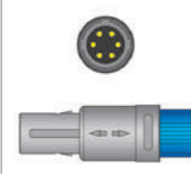
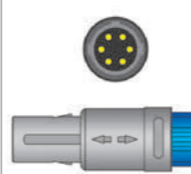

OEM Manufacturer & Models	Sensor Connector	REF# OEM	REF# UNIMED	Sensor Descriptions	Price (unit)	Ext - Cable	Monitor End Conn.	Sensor End Conn.
<b>LG Medical Design</b>								
VitalView I, VitalView II	 6-pin lemo connector, 2 notches, 40° keyed		<b>U110-65D</b>	Pediatric finger clip, 3.0m	C8	Direct		
			<b>U110S-65D</b>	Pediatric soft tip, 3.0m	C8			
			<b>U210S-65D</b>	Infant soft tip, 3.0m	C8			
			<b>U310-65D</b>	Neonate wrap, 3.0m	C8			
			<b>U410-65D</b>	Adult finger clip, 3.0m	C7			
			<b>U410S-65D</b>	Adult soft tip, 3.0m	C8			
			<b>U610-65D</b>	Adult/Neonate wrap, 3.0m	C7			
			<b>U610B-65D</b>	Pediatric/Infant wrap, 3.0m	C7			
			<b>U810-65D</b>	Multi-site, 3.0m	C7			
			<b>U910-65D</b>	Adult ear clip, 3.0m	C8			
	 9-pin connector, Keyed	See Digital Tech		2.2m		U708-65	 	
<b>Lohmeier</b>								
M010, M011	 6-pin connector, keyed		<b>U110-64</b>	Pediatric finger clip, 3.0m	D1	Direct		
			<b>U110S-64</b>	Pediatric soft tip, 3.0m	D1			
			<b>U210S-64</b>	Infant soft tip, 3.0m	D1			
			<b>U310-64</b>	Neonate wrap, 3.0m	D1			
			<b>U410-64</b>	Adult finger clip, 3.0m	C8			
			<b>U410S-64</b>	Adult soft tip, 3.0m	D1			
			<b>U610-64</b>	Adult/Neonate wrap, 3.0m	C8			
			<b>U610B-64</b>	Pediatric/Infant wrap, 3.0m	C8			
			<b>U810-64</b>	Multi-site, 3.0m	C8			
			<b>U910-64</b>	Adult ear clip, 3.0m	D1			
		6051-0000-035						
<b>Lumeon</b>								
Hand-held Oximeter	 9-pin connector, keyed		<b>U103-01</b>	Pediatric finger clip ,1.1m	C5	Direct		
			<b>U103S-01</b>	Pediatric soft tip ,1.1m	C5			
			<b>U203S-01</b>	Infant soft tip ,1.1m	C5			
			<b>U303-01</b>	Neonate wrap ,1.1m	C5			
			<b>U403-01</b>	Adult finger clip ,1.1m	C3.8			
			<b>U403S-01</b>	Adult soft tip ,1.1m	C5			
			<b>U603-01</b>	Adult/Neonate wrap ,1.1m	C3.8			
			<b>U603B-01</b>	Pediatric/Infant wrap ,1.1m	C3.8			
			<b>U803-01</b>	Multi-site ,1.1m	C3.8			
			<b>U903-01</b>	Adult ear clip ,1.1m	C5			
<b>Lutech</b>								
Datatys 780 (*Digital Tech)	 6-pin lemo connector, 1 notch		<b>U110-66D</b>	Pediatric finger clip, 3.0m	D1	Direct		
			<b>U110S-66D</b>	Pediatric soft tip, 3.0m	D1			
			<b>U210S-66D</b>	Infant soft tip, 3.0m	D1			
			<b>U310-66D</b>	Neonate wrap, 3.0m	D1			
			<b>U410-66D</b>	Adult finger clip, 3.0m	C8			
			<b>U410S-66D</b>	Adult soft tip, 3.0m	D1			
			<b>U610-66D</b>	Adult/Neonate wrap, 3.0m	C8			
			<b>U610B-66D</b>	Pediatric/Infant wrap, 3.0m	C8			
			<b>U810-66D</b>	Multi-site, 3.0m	C8			
			<b>U910-66D</b>	Adult ear clip, 3.0m	D1			
	 9-pin connector, Keyed	See Digital Tech		2.2m		U708-45	 	
		See Digital Tech						



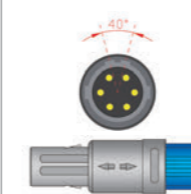

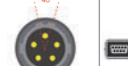



OEM Manufacturer & Models	Sensor Connector	REF# OEM	REF# UNIMED	Sensor Descriptions	Price (unit)	Ext - Cable	Monitor End Conn.	Sensor End Conn.
<b>M-Tech</b>								
Compatible with M-Tech 11-pin M-LNCS connector (*M-Tech Rainbow)	 M-LNCS connector	2502/M-LNCS DCP	<b>U103-203</b>	Pediatric finger clip, 1.1m	D1	U708MR-15		
			<b>U103S-203</b>	Pediatric soft tip, 1.1m	D1			
			<b>U203S-203</b>	Infant soft tip, 1.1m	D1			
			<b>U303-203</b>	Neonate wrap, 1.1m	D1			
			<b>U403-203</b>	Adult finger clip, 1.1m	C8			
			<b>U403S-203</b>	Adult soft tip, 1.1m	D1			
			<b>U603-203</b>	Adult/Neonate wrap, 1.1m	C8			
			<b>U603B-203</b>	Pediatric/Infant wrap, 1.1m	C8			
			<b>U803-203</b>	Multi-site, 1.1m	C8			
			<b>U903-203</b>	Adult ear clip, 1.1m	D1			
Compatible with M-Tech 9-pin (DB9) LNCS connector (*M-Tech Rainbow)	 9-pin connector, keyed	1864/LNCS DCP	<b>U103-49R</b>	Pediatric finger clip, 1.1m	C8.1	U710M-15R (1814/LNC-10)		
			<b>U103S-49R</b>	Pediatric soft tip, 1.1m	C8.1			
			<b>U203S-49R</b>	Infant soft tip, 1.1m	C8.1			
			<b>U303-49R</b>	Neonate wrap, 1.1m	C8.1			
		1863/LNCS DCI	<b>U403-49R</b>	Adult finger clip, 1.1m	C6.7			
		2653/LNCS DBI	<b>U403S-49R</b>	Adult soft tip, 1.1m	C8.1			
			<b>U603-49R</b>	Adult/Neonate wrap, 1.1m	C6.7			
			<b>U603B-49R</b>	Pediatric/Infant wrap, 1.1m	C6.7			
		2258/LNCS YI	<b>U803-49R</b>	Multi-site, 1.1m	C6.7			
		1895/LNCS TC-I	<b>U903-49R</b>	Adult ear clip, 1.1m	C8.1			
Compatible with M-Tech 6-pin LNOP connector (*M-Tech Rainbow)	 LNOP connector	1276/LNOP DCP	<b>U103-125R</b>	Pediatric finger clip, 1.1m	C8	U708M-15PR (1005/PC08)		
			<b>U103S-125R</b>	Pediatric soft tip, 1.1m	C8			
			<b>U203S-125R</b>	Infant soft tip, 1.1m	C8			
			<b>U303-125R</b>	Neonate wrap, 1.1m	C8			
		1269/LNOP DCI	<b>U403-125R</b>	Adult finger clip, 1.1m	C7			
			<b>U403S-125R</b>	Adult soft tip, 1.1m	C8			
			<b>U603-125R</b>	Adult/Neonate wrap, 1.1m	C7			
			<b>U603B-125R</b>	Pediatric/Infant wrap, 1.1m	C7			
		1544/LNOP YI	<b>U803-125R</b>	Multi-site, 1.1m	C7			
		1797/LNOP TC-I	<b>U903-125R</b>	Adult ear clip, 1.1m	C8			
Compatible with M-Tech RD SET connector (*M-Tech)	 RD SET connector	4051/RD SET DCP	<b>U103-254</b>	Pediatric finger clip, 1.1m	C8.9	U708M-15RD		
			<b>U103S-254</b>	Pediatric soft tip, 1.1m	C8.9			
			<b>U203S-254</b>	Infant soft tip, 1.1m	C8.9			
			<b>U303-254</b>	Neonate wrap, 1.1m	C8.9			
		4050/RD SET DCI	<b>U403-254</b>	Adult finger clip, 1.1m	C8			
		4052/RD SET DBI	<b>U403S-254</b>	Adult soft tip, 1.1m	C8.9			
			<b>U603-254</b>	Adult/Neonate wrap, 1.1m	C8			
			<b>U603B-254</b>	Pediatric/Infant wrap, 1.1m	C8			
		4054/RD SET YI	<b>U803-254</b>	Multi-site, 1.1m	C8			
		4053/RD SET TC-I	<b>U903-254</b>	Adult ear clip, 1.1m	C8.9			

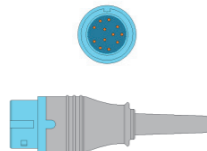



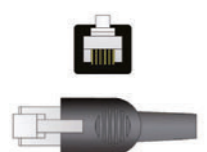
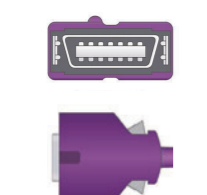

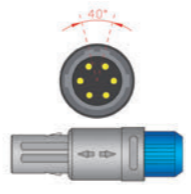

M-Tech Next Page

OEM Manufacturer & Models	Sensor Connector	REF# OEM	REF# UNIMED	Sensor Descriptions	Price (unit)	Ext - Cable	Monitor End Conn.	Sensor End Conn.
<b>M-Tech</b>								
Compatible with M-Tech 14-pin connector (*M-Tech Rainbow)	 14-pin connector		<b>U110-15R</b>	Pediatric finger clip, 3.0m	D1	Direct		
			<b>U110S-15R</b>	Pediatric soft tip, 3.0m	D1			
			<b>U210S-15R</b>	Infant soft tip, 3.0m	D1			
			<b>U310-15R</b>	Neonate wrap, 3.0m	D1			
		2387/DC-8	<b>U410-15R</b>	Adult finger clip, 3.0m	C8			
		2652/DBI-DC8	<b>U410S-15R</b>	Adult soft tip, 3.0m	D1			
			<b>U610-15R</b>	Adult/Neonate wrap, 3.0m	C8			
			<b>U610B-15R</b>	Pediatric/Infant wrap, 3.0m	C8			
			<b>U810-15R</b>	Multi-site, 3.0m	C8			
			<b>U910-15R</b>	Adult ear clip, 3.0m	D1			
Compatible with M-Tech 20-pin connector (*M-Tech Rainbow)	 20-pin connector, keyed		<b>U110-87</b>	Pediatric finger clip, 3.0m	D3	Direct		
			<b>U110S-87</b>	Pediatric soft tip, 3.0m	D3			
			<b>U210S-87</b>	Infant soft tip, 3.0m	D3			
			<b>U310-87</b>	Neonate wrap, 3.0m	D3			
		2054/Red DCI-dk12	<b>U410-87</b>	Adult finger clip, 3.0m	D2			
		2644/Red DBI-dk6	<b>U410S-87</b>	Adult soft tip, 3.0m	D3			
			<b>U610-87</b>	Adult/Neonate wrap, 3.0m	D2			
			<b>U610B-87</b>	Pediatric/Infant wrap, 3.0m	D2			
			<b>U810-87</b>	Multi-site, 3.0m	D2			
			<b>U910-87</b>	Adult ear clip, 3.0m	D3			
<b>MDE</b>								
20300,20401,20403, Prism	 9-pin connector, keyed		<b>U110-01</b>	Pediatric finger clip, 3.0m	C7	Direct		
			<b>U110S-01</b>	Pediatric soft tip, 3.0m	C7			
			<b>U210S-01</b>	Infant soft tip, 3.0m	C7			
			<b>U310-01</b>	Neonate wrap, 3.0m	C7			
			<b>U410-01</b>	Adult finger clip, 3.0m	C5			
			<b>U410S-01</b>	Adult soft tip, 3.0m	C7			
			<b>U610-01</b>	Adult/Neonate wrap, 3.0m	C5			
			<b>U610B-01</b>	Pediatric/Infant wrap, 3.0m	C5			
			<b>U810-01</b>	Multi-site, 3.0m	C5			
	<b>U910-01</b>	Adult ear clip, 3.0m	C7					
Millenia, Escort, M10TM,M12TM,M8TM (*M-Tech)	 14-pin connector		<b>U110-15R</b>	Pediatric finger clip, 3.0m	D1	Direct		
			<b>U110S-15R</b>	Pediatric soft tip, 3.0m	D1			
			<b>U210S-15R</b>	Infant soft tip, 3.0m	D1			
			<b>U310-15R</b>	Neonate wrap, 3.0m	D1			
		01-02-0730, 01-02-0712	<b>U410-15R</b>	Adult finger clip, 3.0m	C8			
			<b>U410S-15R</b>	Adult soft tip, 3.0m	D1			
			<b>U610-15R</b>	Adult/Neonate wrap, 3.0m	C8			
			<b>U610B-15R</b>	Pediatric/Infant wrap, 3.0m	C8			
			<b>U810-15R</b>	Multi-site, 3.0m	C8			
			<b>U910-15R</b>	Adult ear clip, 3.0m	D1			
	 9-pin connector, Keyed	See M-Tech U*03-49R Series Sensor		2.2m		U708M-15R	 	



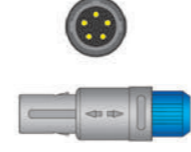

OEM Manufacturer & Models	Sensor Connector	REF# OEM	REF# UNIMED	Sensor Descriptions	Price (unit)	Ext - Cable	Monitor End Conn.	Sensor End Conn.
<b>MedChoice</b>								
M12 (*Digital Tech)	 6-pin lemo connector, 1 notch		<b>U110-84D</b>	Pediatric finger clip, 3.0m	D1	Direct		
			<b>U110S-84D</b>	Pediatric soft tip, 3.0m	D1			
			<b>U210S-84D</b>	Infant soft tip, 3.0m	D1			
			<b>U310-84D</b>	Neonate wrap, 3.0m	D1			
			<b>U410-84D</b>	Adult finger clip, 3.0m	C8			
			<b>U410S-84D</b>	Adult soft tip, 3.0m	D1			
			<b>U610-84D</b>	Adult/Neonate wrap, 3.0m	C8			
			<b>U610B-84D</b>	Pediatric/Infant wrap, 3.0m	C8			
			<b>U810-84D</b>	Multi-site, 3.0m	C8			
			<b>U910-84D</b>	Adult ear clip, 3.0m	D1			
M12, M7 (*BCI Tech)	 6-pin lemo connector, 1 notch		<b>U110-96</b>	Pediatric finger clip, 3.0m	C8	Direct		
			<b>U110S-96</b>	Pediatric soft tip, 3.0m	C8			
			<b>U210S-96</b>	Infant soft tip, 3.0m	C8			
			<b>U310-96</b>	Neonate wrap, 3.0m	C8			
			<b>U410-96</b>	Adult finger clip, 3.0m	C7			
			<b>U410S-96</b>	Adult soft tip, 3.0m	C8			
			<b>U610-96</b>	Adult/Neonate wrap, 3.0m	C7			
			<b>U610B-96</b>	Pediatric/Infant wrap, 3.0m	C7			
			<b>U810-96</b>	Multi-site, 3.0m	C7			
			<b>U910-96</b>	Adult ear clip, 3.0m	C8			
	 9-pin connector	See BCI U*03-06 Series Sensor		2.2m		U708-96	 	
<b>Medec</b>								
M-1000, M-1100, MEDEC-1000	 6-pin lemo connector, 2 notches, 40° keyed		<b>U110-29</b>	Pediatric finger clip, 3.0m	C7	Direct		
			<b>U110S-29</b>	Pediatric soft tip, 3.0m	C7			
			<b>U210S-29</b>	Infant soft tip, 3.0m	C7			
			<b>U310-29</b>	Neonate wrap, 3.0m	C7			
			<b>U410-29</b>	Adult finger clip, 3.0m	C5			
			<b>U410S-29</b>	Adult soft tip, 3.0m	C7			
			<b>U610-29</b>	Adult/Neonate wrap, 3.0m	C5			
			<b>U610B-29</b>	Pediatric/Infant wrap, 3.0m	C5			
			<b>U810-29</b>	Multi-site, 3.0m	C5			
			<b>U910-29</b>	Adult ear clip, 3.0m	C7			
	 9-pin connector, Keyed	See NE-Tech (OxiSmart) U*03-01 Series Sensor		2.2m		U708-29	 	

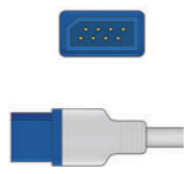



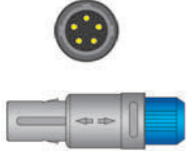



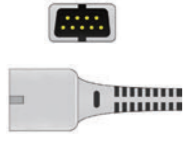

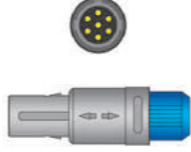
OEM Manufacturer & Models	Sensor Connector	REF# OEM	REF# UNIMED	Sensor Descriptions	Price (unit)	Ext - Cable	Monitor End Conn.	Sensor End Conn.
<b>Medexcel</b>								
MD50 (*Digital Tech)	 12-pin connector, keyed		<b>U110-208D</b>	Pediatric finger clip, 3.0m	C7	Direct		
			<b>U110S-208D</b>	Pediatric soft tip, 3.0m	C7			
			<b>U210S-208D</b>	Infant soft tip, 3.0m	C7			
			<b>U310-208D</b>	Neonate wrap, 3.0m	C7			
			<b>U410-208D</b>	Adult finger clip, 3.0m	C5			
			<b>U410S-208D</b>	Adult soft tip, 3.0m	C7			
			<b>U610-208D</b>	Adult/Neonate wrap, 3.0m	C5			
			<b>U610B-208D</b>	Pediatric/Infant wrap, 3.0m	C5			
			<b>U810-208D</b>	Multi-site, 3.0m	C5			
			<b>U910-208D</b>	Adult ear clip, 3.0m	C7			
	 9-pin connector, Keyed	See NE-Tech (OxiSmart) U*03-01 Series Sensor	2.2m		U708-208D			
<b>Mediaid</b>								
ALL	 6-pin connector, keyed		<b>U110-18</b>	Pediatric finger clip, 3.0m	C8	Direct		
			<b>U110S-18</b>	Pediatric soft tip, 3.0m	C8			
			<b>U210S-18</b>	Infant soft tip, 3.0m	C8			
			<b>U310-18</b>	Neonate wrap, 3.0m	C8			
			<b>U410-18</b>	Adult finger clip, 3.0m	C7			
			<b>U410S-18</b>	Adult soft tip, 3.0m	C8			
			<b>U610-18</b>	Adult/Neonate wrap, 3.0m	C7			
			<b>U610B-18</b>	Pediatric/Infant wrap, 3.0m	C7			
			<b>U810-18</b>	Multi-site, 3.0m	C7			
			<b>U910-18</b>	Adult ear clip, 3.0m	C8			
<b>Mediana</b>								
YM6000, M20 (*NE-Tech OxiMax)	 12-pin connector, keyed		<b>U110-70P</b>	Pediatric finger clip, 3.0m	D2	Direct		
			<b>U110S-70P</b>	Pediatric soft tip, 3.0m	D2			
			<b>U210S-70P</b>	Infant soft tip, 3.0m	D2			
			<b>U310-70P</b>	Neonate wrap, 3.0m	D2			
			<b>U410-70P</b>	Adult finger clip, 3.0m	D1			
			<b>U410S-70P</b>	Adult soft tip, 3.0m	D2			
			<b>U610-70P</b>	Adult/Neonate wrap, 3.0m	D1			
			<b>U610B-70P</b>	Pediatric/Infant wrap, 3.0m	D1			
			<b>U810-70P</b>	Multi-site, 3.0m	D1			
			<b>U910-70P</b>	Adult ear clip, 3.0m	D2			
	 9-pin connector, Keyed	See NE-Tech (OxiMax) U*03-01P Series Sensor	2.2m		U708-70			

OEM Manufacturer & Models	Sensor Connector	REF# OEM	REF# UNIMED	Sensor Descriptions	Price (unit)	Ext - Cable	Monitor End Conn.	Sensor End Conn.
<b>Mediblu</b>								
MM12 (*Digital Tech)	 6-pin lemo connector, 2 notches, 40° keyed		<b>U110-65D</b>	Pediatric finger clip, 3.0m	C8	Direct		
			<b>U110S-65D</b>	Pediatric soft tip, 3.0m	C8			
			<b>U210S-65D</b>	Infant soft tip, 3.0m	C8			
			<b>U310-65D</b>	Neonate wrap, 3.0m	C8			
			<b>U410-65D</b>	Adult finger clip, 3.0m	C7			
			<b>U410S-65D</b>	Adult soft tip, 3.0m	C8			
			<b>U610-65D</b>	Adult/Neonate wrap, 3.0m	C7			
			<b>U610B-65D</b>	Pediatric/Infant wrap, 3.0m	C7			
			<b>U810-65D</b>	Multi-site, 3.0m	C7			
			<b>U910-65D</b>	Adult ear clip, 3.0m	C8			
	 9-pin connector, Keyed	See Digital Tech U*03-42D Series Sensor	2.2m		U708-65			
MM12	 5-pin lemo connector, 1 notch		<b>U110-37</b>	Pediatric finger clip, 3.0m	C8	Direct		
			<b>U110S-37</b>	Pediatric soft tip, 3.0m	C8			
			<b>U210S-37</b>	Infant soft tip, 3.0m	C8			
			<b>U310-37</b>	Neonate wrap, 3.0m	C8			
			<b>U410-37</b>	Adult finger clip, 3.0m	C7			
			<b>U410S-37</b>	Adult soft tip, 3.0m	C8			
			<b>U610-37</b>	Adult/Neonate wrap, 3.0m	C7			
			<b>U610B-37</b>	Pediatric/Infant wrap, 3.0m	C7			
			<b>U810-37</b>	Multi-site, 3.0m	C7			
			<b>U910-37</b>	Adult ear clip, 3.0m	C8			
	 9-pin connector, Keyed	See NE-Tech (OxiSmart) U*03-01 Series Sensor	2.2m		U708-37			
<b>Medica D</b>								
Logicare Series 2000	 8-pin connector, keyed		<b>U110-227</b>	Pediatric finger clip, 3.0m	D1.3	Direct		
			<b>U110S-227</b>	Pediatric soft tip, 3.0m	D1.3			
			<b>U210S-227</b>	Infant soft tip, 3.0m	D1.3			
			<b>U310-227</b>	Neonate wrap, 3.0m	D1.3			
			<b>U410-227</b>	Adult finger clip, 3.0m	C8.7			
			<b>U410S-227</b>	Adult soft tip, 3.0m	D1.3			
			<b>U610-227</b>	Adult/Neonate wrap, 3.0m	C8.7			
			<b>U610B-227</b>	Pediatric/Infant wrap, 3.0m	C8.7			
			<b>U810-227</b>	Multi-site, 3.0m	C8.7			
			<b>U910-227</b>	Adult ear clip, 3.0m	D1.3			

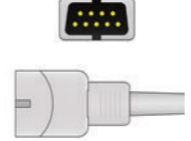

Medica D Next Page

OEM Manufacturer & Models	Sensor Connector	REF# OEM	REF# UNIMED	Sensor Descriptions	Price (unit)	Ext - Cable	Monitor End Conn.	Sensor End Conn.
<b>Medica D</b>								
Vitacare (*Digital Tech)	 5-pin lemo connector, 1 notch		<b>U110-46D</b>	Pediatric finger clip, 3.0m	C7	Direct		
			<b>U110S-46D</b>	Pediatric soft tip, 3.0m	C7			
			<b>U210S-46D</b>	Infant soft tip, 3.0m	C7			
			<b>U310-46D</b>	Neonate wrap, 3.0m	C7			
			<b>U410-46D</b>	Adult finger clip, 3.0m	C5			
			<b>U410S-46D</b>	Adult soft tip, 3.0m	C7			
			<b>U610-46D</b>	Adult/Neonate wrap, 3.0m	C5			
			<b>U610B-46D</b>	Pediatric/Infant wrap, 3.0m	C5			
			<b>U810-46D</b>	Multi-site, 3.0m	C5			
			<b>U910-46D</b>	Adult ear clip, 3.0m	C7			
	 9-pin connector, Keyed	See Digital Tech U*03-42D Series Sensor	2.2m		U708-47			
<b>Medtronic &gt; Physio Control</b>								
Lifepak 11, Lifepak 12, Lifepak 15, Lifepak 20, Lifepak 20E  (*M-Tech)	 14-pin connector		<b>U110-15R</b>	Pediatric finger clip, 3.0m	D1	Direct		
			<b>U110S-15R</b>	Pediatric soft tip, 3.0m	D1			
			<b>U210S-15R</b>	Infant soft tip, 3.0m	D1			
			<b>U310-15R</b>	Neonate wrap, 3.0m	D1			
			<b>U410-15R</b>	Adult finger clip, 3.0m	C8			
			<b>U410S-15R</b>	Adult soft tip, 3.0m	D1			
			<b>U610-15R</b>	Adult/Neonate wrap, 3.0m	C8			
			<b>U610B-15R</b>	Pediatric/Infant wrap, 3.0m	C8			
			<b>U810-15R</b>	Multi-site, 3.0m	C8			
			<b>U910-15R</b>	Adult ear clip, 3.0m	D1			
	 9-pin connector, Keyed	See M-Tech U*03-49R Series Sensor	2.2m		U708M-15R			
Lifepak 12  (*NE Tech OxiSmart)	 9-pin connector, keyed		<b>U110-01</b>	Pediatric finger clip, 3.0m	C7	Direct		
			<b>U110S-01</b>	Pediatric soft tip, 3.0m	C7			
			<b>U210S-01</b>	Infant soft tip, 3.0m	C7			
			<b>U310-01</b>	Neonate wrap, 3.0m	C7			
			<b>U410-01</b>	Adult finger clip, 3.0m	C5			
			<b>U410S-01</b>	Adult soft tip, 3.0m	C7			
			<b>U610-01</b>	Adult/Neonate wrap, 3.0m	C5			
			<b>U610B-01</b>	Pediatric/Infant wrap, 3.0m	C5			
			<b>U810-01</b>	Multi-site, 3.0m	C5			
			<b>U910-01</b>	Adult ear clip, 3.0m	C7			













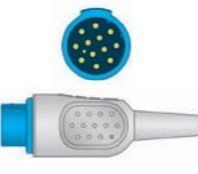

OEM Manufacturer & Models	Sensor Connector	REF# OEM	REF# UNIMED	Sensor Descriptions	Price (unit)	Ext - Cable	Monitor End Conn.	Sensor End Conn.
<b>Medlab</b>								
NANOX 10, POX 10, Perarl 10 (*BCI Tech)	 7-pin lemo connector, 1 notch		<b>U110-76</b>	Pediatric finger clip, 3.0m	C8	Direct		
			<b>U110S-76</b>	Pediatric soft tip, 3.0m	C8			
			<b>U210S-76</b>	Infant soft tip, 3.0m	C8			
			<b>U310-76</b>	Neonate wrap, 3.0m	C8			
			<b>U410-76</b>	Adult finger clip, 3.0m	C7			
			<b>U410S-76</b>	Adult soft tip, 3.0m	C8			
			<b>U610-76</b>	Adult/Neonate wrap, 3.0m	C7			
			<b>U610B-76</b>	Pediatric/Infant wrap, 3.0m	C7			
			<b>U810-76</b>	Multi-site, 3.0m	C7			
			<b>U910-76</b>	Adult ear clip, 3.0m	C8			
	 9-pin connector, Keyed	See BCI U*03-06 Series Sensor	2.2m		U708-76			
<b>MEK</b>								
MP1000 NT	 8-pin connector, 1 notch		<b>U110-56</b>	Pediatric finger clip, 3.0m	C8	Direct		
			<b>U110S-56</b>	Pediatric soft tip, 3.0m	C8			
			<b>U210S-56</b>	Infant soft tip, 3.0m	C8			
			<b>U310-56</b>	Neonate wrap, 3.0m	C8			
			<b>U410-56</b>	Adult finger clip, 3.0m	C7			
			<b>U410S-56</b>	Adult soft tip, 3.0m	C8			
			<b>U610-56</b>	Adult/Neonate wrap, 3.0m	C7			
			<b>U610B-56</b>	Pediatric/Infant wrap, 3.0m	C7			
			<b>U810-56</b>	Multi-site, 3.0m	C7			
			<b>U910-56</b>	Adult ear clip, 3.0m	C8			
	 9-pin connector, Keyed	See NE-Tech (OxiSmart) U*03-01 Series Sensor	2.2m		U708-56			
MP100,MP110,MP400,MP 1000  (*MEK Tech)	 9-pin connector, keyed		<b>U110-26</b>	Pediatric finger clip, 3.0m	C7	Direct		
			<b>U110S-26</b>	Pediatric soft tip, 3.0m	C7			
			<b>U210S-26</b>	Infant soft tip, 3.0m	C7			
			<b>U310-26</b>	Neonate wrap, 3.0m	C7			
			<b>U410-26</b>	Adult finger clip, 3.0m	C5			
			<b>U410S-26</b>	Adult soft tip, 3.0m	C7			
			<b>U610-26</b>	Adult/Neonate wrap, 3.0m	C5			
			<b>U610B-26</b>	Pediatric/Infant wrap, 3.0m	C5			
			<b>U810-26</b>	Multi-site, 3.0m	C5			
			<b>U910-26</b>	Adult ear clip, 3.0m	C7			

MEK Next Page



OEM Manufacturer & Models	Sensor Connector	REF# OEM	REF# UNIMED	Sensor Descriptions	Price (unit)	Ext - Cable	Monitor End Conn.	Sensor End Conn.
<b>MEK</b>								
MP 7000, PM 800 (PAMO II)			<b>U110-27</b>	Pediatric finger clip, 3.0m	D1	Direct		
			<b>U110S-27</b>	Pediatric soft tip, 3.0m	D1			
			<b>U210S-27</b>	Infant soft tip, 3.0m	D1			
			<b>U310-27</b>	Neonate wrap, 3.0m	D1			
			<b>U410-27</b>	Adult finger clip, 3.0m	C8			
			<b>U410S-27</b>	Adult soft tip, 3.0m	D1			
			<b>U610-27</b>	Adult/Neonate wrap, 3.0m	C8			
			<b>U610B-27</b>	Pediatric/Infant wrap, 3.0m	C8			
			<b>U810-27</b>	Multi-site, 3.0m	C8			
			<b>U910-27</b>	Adult ear clip, 3.0m	D1			
		See NE-Tech (OxiSmart) U*03-01 Series Sensor	2.2m		U708-27			
PM 800 (PAMO II) PM570 PM2500 MP700			<b>U110-249</b>	Pediatric finger clip, 3.0m	C7	Direct		
			<b>U110S-249</b>	Pediatric soft tip, 3.0m	C7			
			<b>U210S-249</b>	Infant soft tip, 3.0m	C7			
			<b>U310-249</b>	Neonate wrap, 3.0m	C7			
			<b>U410-249</b>	Adult finger clip, 3.0m	C5			
			<b>U410S-249</b>	Adult soft tip, 3.0m	C7			
			<b>U610-249</b>	Adult/Neonate wrap, 3.0m	C5			
			<b>U610B-249</b>	Pediatric/Infant wrap, 3.0m	C5			
			<b>U810-249</b>	Multi-site, 3.0m	C5			
			<b>U910-249</b>	Adult ear clip, 3.0m	C7			
		See NE-Tech (OxiSmart) U*03-01 Series Sensor	2.2m		U708-249			
<b>Mennen</b>								
Envoy			<b>U110-54</b>	Pediatric finger clip, 3.0m	C8	Direct		
			<b>U110S-54</b>	Pediatric soft tip, 3.0m	C8			
			<b>U210S-54</b>	Infant soft tip, 3.0m	C8			
			<b>U310-54</b>	Neonate wrap, 3.0m	C8			
			<b>U410-54</b>	Adult finger clip, 3.0m	C7			
			<b>U410S-54</b>	Adult soft tip, 3.0m	C8			
			<b>U610-54</b>	Adult/Neonate wrap, 3.0m	C7			
			<b>U610B-54</b>	Pediatric/Infant wrap, 3.0m	C7			
			<b>U810-54</b>	Multi-site, 3.0m	C7			
			<b>U910-54</b>	Adult ear clip, 3.0m	C8			
		See NE-Tech (OxiSmart) U*03-01 Series Sensor	2.2m		U708-54			

Mennen Next Page

OEM Manufacturer & Models	Sensor Connector	REF# OEM	REF# UNIMED	Sensor Descriptions	Price (unit)	Ext - Cable	Monitor End Conn.	Sensor End Conn.
<b>Mennen</b>								
Horizon 1100,2000X			See NE-Tech (OxiSmart) U*03-01 Series Sensor	2.2m		U708-85		
Horizon 2000 Mercury 1200			<b>U110-24</b>	Pediatric finger clip, 3.0m	D1	Direct		
			<b>U110S-24</b>	Pediatric soft tip, 3.0m	D1			
			<b>U210S-24</b>	Infant soft tip, 3.0m	D1			
			<b>U310-24</b>	Neonate wrap, 3.0m	D1			
			<b>U410-24</b>	Adult finger clip, 3.0m	C8			
			<b>U410S-24</b>	Adult soft tip, 3.0m	D1			
			<b>U610-24</b>	Adult/Neonate wrap, 3.0m	C8			
			<b>U610B-24</b>	Pediatric/Infant wrap, 3.0m	C8			
			<b>U810-24</b>	Multi-site, 3.0m	C8			
			<b>U910-24</b>	Adult ear clip, 3.0m	D1			
		See NE-Tech (OxiSmart) U*03-01 Series Sensor	2.2m		U708-24			
Vitalogik 4500 (*NE-Tech OxiMax)			<b>U110-59P</b>	Pediatric finger clip, 3.0m	D1	Direct		
			<b>U110S-59P</b>	Pediatric soft tip, 3.0m	D1			
			<b>U210S-59P</b>	Infant soft tip, 3.0m	D1			
			<b>U310-59P</b>	Neonate wrap, 3.0m	D1			
			<b>U410-59P</b>	Adult finger clip, 3.0m	C8			
			<b>U410S-59P</b>	Adult soft tip, 3.0m	D1			
			<b>U610-59P</b>	Adult/Neonate wrap, 3.0m	C8			
			<b>U610B-59P</b>	Pediatric/Infant wrap, 3.0m	C8			
			<b>U810-59P</b>	Multi-site, 3.0m	C8			
			<b>U910-59P</b>	Adult ear clip, 3.0m	D1			
		See NE-Tech (OxiMax) U*03-01P Series Sensor	2.2m		U708X-59			
Horizon, Envoy, Vitalogik (M) (*M-Tech)			<b>U110-59M</b>	Pediatric finger clip, 3.0m	C8	Direct		
			<b>U110S-59M</b>	Pediatric soft tip, 3.0m	C8			
			<b>U210S-59M</b>	Infant soft tip, 3.0m	C8			
			<b>U310-59M</b>	Neonate wrap, 3.0m	C8			
			<b>U410-59M</b>	Adult finger clip, 3.0m	C7			
			<b>U410S-59M</b>	Adult soft tip, 3.0m	C8			
			<b>U610-59M</b>	Adult/Neonate wrap, 3.0m	C7			
			<b>U610B-59M</b>	Pediatric/Infant wrap, 3.0m	C7			
			<b>U810-59M</b>	Multi-site, 3.0m	C7			
			<b>U910-59M</b>	Adult ear clip, 3.0m	C8			
		See M-Tech U*03-49R Series Sensor	2.2m		U708M-59			





Mennen Next Page

OEM Manufacturer & Models	Sensor Connector	REF# OEM	REF# UNIMED	Sensor Descriptions	Price (unit)	Ext - Cable	Monitor End Conn.	Sensor End Conn.
<b>Mennen</b>								
Horizon XL  (*Ohmeda Tech) (Ohmeda Connector)			<b>U110-02</b>	Pediatric finger clip, 3.0m	D1			
			<b>U110S-02</b>	Pediatric soft tip, 3.0m	D1			
			<b>U210S-02</b>	Infant soft tip, 3.0m	D1			
			<b>U310-02</b>	Neonate wrap, 3.0m	D1			
			<b>U410-02</b>	Adult finger clip, 3.0m	C8			
			<b>U410S-02</b>	Adult soft tip, 3.0m	D1	Direct		
			<b>U610-02</b>	Adult/Neonate wrap, 3.0m	C8			
			<b>U610B-02</b>	Pediatric/Infant wrap, 3.0m	C8			
			<b>U810-02</b>	Multi-site, 3.0m	C8			
			<b>U910-02</b>	Adult ear clip, 3.0m	D1			
<b>Midmark &gt; Cardell</b>								
9403, 9500HD  (*NE-Tech OxiMax)			<b>U110-70P</b>	Pediatric finger clip, 3.0m	D2			
			<b>U110S-70P</b>	Pediatric soft tip, 3.0m	D2			
			<b>U210S-70P</b>	Infant soft tip, 3.0m	D2			
			<b>U310-70P</b>	Neonate wrap, 3.0m	D2			
			<b>U410-70P</b>	Adult finger clip, 3.0m	D1	Direct		
			<b>U410S-70P</b>	Adult soft tip, 3.0m	D2			
			<b>U610-70P</b>	Adult/Neonate wrap, 3.0m	D1			
			<b>U610B-70P</b>	Pediatric/Infant wrap, 3.0m	D1			
			<b>U810-70P</b>	Multi-site, 3.0m	D1			
			<b>U910-70P</b>	Adult ear clip, 3.0m	D2			
		See NE-Tech (OxiMax) U*03-01P Series Sensor		2.2m		U708-70		
<b>Mindray &gt; Datascope</b>								
Accusat, Accutorr 3 SAT, Accutorr 4 SAT, Accutorr Plus, Passport, Passport 2, Passport 2LT, Passport IL, Passport XG, Passport XL  (*Datascope Tech)			<b>U110-07</b>	Pediatric finger clip, 3.0m	C8			
			<b>U110S-07</b>	Pediatric soft tip, 3.0m	C8			
			<b>U210S-07</b>	Infant soft tip, 3.0m	C8			
			<b>U310-07</b>	Neonate wrap, 3.0m	C8			
			<b>U410-07</b>	Adult finger clip, 3.0m	C7	Direct		
			<b>U410S-07</b>	Adult soft tip, 3.0m	C8			
			<b>U610-07</b>	Adult/Neonate wrap, 3.0m	C7			
			<b>U610B-07</b>	Pediatric/Infant wrap, 3.0m	C7			
			<b>U810-07</b>	Multi-site, 3.0m	C7			
			<b>U910-07</b>	Adult ear clip, 3.0m	C8			
			<b>U103-07</b>	Pediatric finger clip, 1.1m	C5			
			<b>U103S-07</b>	Pediatric soft tip, 1.1m	C5			
			<b>U203S-07</b>	Infant soft tip, 1.1m	C5			
			<b>U303-07</b>	Neonate wrap, 1.1m	C5			
			<b>U403-07</b>	Adult finger clip, 1.1m	C3.8	U708-07 (0012-00-0516-01/0012-00-0516-02)		
	<b>U403S-07</b>	Adult soft tip, 1.1m	C5					
	<b>U603-07</b>	Adult/Neonate wrap, 1.1m	C3.8					
	<b>U603B-07</b>	Pediatric/Infant wrap, 1.1m	C3.8					
	<b>U803-07</b>	Multi-site, 1.1m	C3.8					
	<b>U903-07</b>	Adult ear clip, 1.1m	C5					



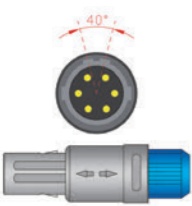
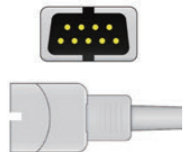

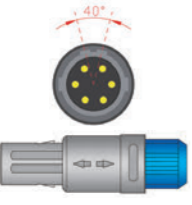

Mindray > Datascope Next Page

OEM Manufacturer & Models	Sensor Connector	REF# OEM	REF# UNIMED	Sensor Descriptions	Price (unit)	Ext - Cable	Monitor End Conn.	Sensor End Conn.	
<b>Mindray &gt; Datascope</b>									
Accutorr V, Duo, Trio, Passport 2, Passport V, Spectrum, Spectrum OR, V12, V21  (*M-Tech)			<b>U110-15R</b>	Pediatric finger clip, 3.0m	D1				
			<b>U110S-15R</b>	Pediatric soft tip, 3.0m	D1				
			<b>U210S-15R</b>	Infant soft tip, 3.0m	D1				
			<b>U310-15R</b>	Neonate wrap, 3.0m	D1				
			<b>U410-15R</b>	Adult finger clip, 3.0m	C8	Direct			
			<b>U410S-15R</b>	Adult soft tip, 3.0m	D1				
			<b>U610-15R</b>	Adult/Neonate wrap, 3.0m	C8				
			<b>U610B-15R</b>	Pediatric/Infant wrap, 3.0m	C8				
			<b>U810-15R</b>	Multi-site, 3.0m	C8				
			<b>U910-15R</b>	Adult ear clip, 3.0m	D1				
(*M-Tech)		0600-00-0127	<b>U103-49R</b>	Pediatric finger clip, 1.1m	C8.1				
			<b>U103S-49R</b>	Pediatric soft tip, 1.1m	C8.1				
			<b>U203S-49R</b>	Infant soft tip, 1.1m	C8.1				
			<b>U303-49R</b>	Neonate wrap, 1.1m	C8.1				
		0600-00-0126	<b>U403-49R</b>	Adult finger clip, 1.1m	C6.7	U710M-15R (0012-00-1599)			
			<b>U403S-49R</b>	Adult soft tip, 1.1m	C8.1				
			<b>U603-49R</b>	Adult/Neonate wrap, 1.1m	C6.7				
			<b>U603B-49R</b>	Pediatric/Infant wrap, 1.1m	C6.7				
			<b>U803-49R</b>	Multi-site, 1.1m	C6.7				
			<b>U903-49R</b>	Adult ear clip, 1.1m	C8.1				
Trio, Passport 2, Spectrum			<b>U110-69</b>	Pediatric finger clip, 3.0m	D1				
			<b>U110S-69</b>	Pediatric soft tip, 3.0m	D1				
			<b>U210S-69</b>	Infant soft tip, 3.0m	D1				
			<b>U310-69</b>	Neonate wrap, 3.0m	D1				
			<b>U410-69</b>	Adult finger clip, 3.0m	C8	Direct			
			<b>U410S-69</b>	Adult soft tip, 3.0m	D1				
			<b>U610-69</b>	Adult/Neonate wrap, 3.0m	C8				
			<b>U610B-69</b>	Pediatric/Infant wrap, 3.0m	C8				
			<b>U810-69</b>	Multi-site, 3.0m	C8				
			<b>U910-69</b>	Adult ear clip, 3.0m	D1				
		See NE-Tech (OxiSmart) U*03-01 Series Sensor		3.0m		U710-69 (0012-00-1254)			
Accutorr V, Duo, Trio, Passport 2, Passport V, Spectrum, Spectrum OR, V12, V21  (*NE-Tech OxiMax)			<b>U110-70P</b>	Pediatric finger clip, 3.0m	D2				
			<b>U110S-70P</b>	Pediatric soft tip, 3.0m	D2				
			<b>U210S-70P</b>	Infant soft tip, 3.0m	D2				
			<b>U310-70P</b>	Neonate wrap, 3.0m	D2				
			<b>U410-70P</b>	Adult finger clip, 3.0m	D1	Direct			
			<b>U410S-70P</b>	Adult soft tip, 3.0m	D2				
			<b>U610-70P</b>	Adult/Neonate wrap, 3.0m	D1				
			<b>U610B-70P</b>	Pediatric/Infant wrap, 3.0m	D1				
			<b>U810-70P</b>	Multi-site, 3.0m	D1				
			<b>U910-70P</b>	Adult ear clip, 3.0m	D2				
		See NE-Tech (OxiMax) U*03-01P Series Sensor		3.0m		U710-70 (0012-00-1464)			

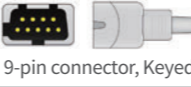
Mindray > Datascope Next Page



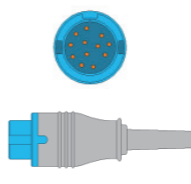





OEM Manufacturer & Models	Sensor Connector	REF# OEM	REF# UNIMED	Sensor Descriptions	Price (unit)	Ext - Cable	Monitor End Conn.	Sensor End Conn.
Mindray > Datascope								
6201, 809B, Accutorr V, DPM1, DPM2, DPM3, DPM4, DPM5, Duo, MEC 100, MEC 1000, MEC 1200, MEC 200, MEC 2000, PM 600, PM 6000 (New), PM 7000, PM 8000, PM 9000, PM 9000 Express, Passport V, Passport XG, Trio, VS 800, VS 900  (*DPM Sp02)			<b>U110-29</b>	Pediatric finger clip, 3.0m	C7	Direct		
			<b>U110S-29</b>	Pediatric soft tip, 3.0m	C7			
			<b>U210S-29</b>	Infant soft tip, 3.0m	C7			
			<b>U310-29</b>	Neonate wrap, 3.0m	C7			
		512FL/040-001403-00	<b>U410-29</b>	Adult finger clip, 3.0m	C5			
			<b>U410S-29</b>	Adult soft tip, 3.0m	C7			
			<b>U610-29</b>	Adult/Neonate wrap, 3.0m	C5			
			<b>U610B-29</b>	Pediatric/Infant wrap, 3.0m	C5			
			<b>U810-29</b>	Multi-site, 3.0m	C5			
			<b>U910-29</b>	Adult ear clip, 3.0m	C7			
		512H/512H-30-79061	<b>U103-01</b>	Pediatric finger clip 1.1m	C5	U708-29 (562A/0010-20-42594)		
		512G/512G-30-90607	<b>U103S-01</b>	Pediatric soft 1.1m	C5			
		518B/518B-30-72107	<b>U303-01</b>	Neonate wrap 1.1m	C5			
		521F/512F-30-28263	<b>U403-01</b>	Adult finger clip 1.1m	C3.8			
		512E/512E-30-90390	<b>U403S-01</b>	Adult soft 1.1m	C5			
		518C/040-000407-00	<b>U603-01</b>	Adult/Neonate wrap, 1.1m	C3.8			
			<b>U603B-01</b>	Pediatric/Infant wrap, 1.1m	C3.8			
			<b>U803-01</b>	Y style Multi-site 1.1m	C3.8			
			<b>U803-01V</b>	Forehead 1.1m	C8.7			
		551A/0010-10-43237	<b>U803-01V6</b>	Veterinary ,clip 1.1m	C6.7			
ES-3212-9/0010-10-12392	<b>U903-01</b>	Adult ear clip 1.1m	C5					
PM-6000, PM-8000  (*M-Tech)			<b>U110-29M</b>	Pediatric finger clip, 3.0m	C7	Direct		
			<b>U110S-29M</b>	Pediatric soft tip, 3.0m	C7			
			<b>U210S-29M</b>	Infant soft tip, 3.0m	C7			
			<b>U310-29M</b>	Neonate wrap, 3.0m	C7			
			<b>U410-29M</b>	Adult finger clip, 3.0m	C5			
			<b>U410S-29M</b>	Adult soft tip, 3.0m	C7			
			<b>U610-29M</b>	Adult/Neonate wrap, 3.0m	C5			
			<b>U610B-29M</b>	Pediatric/Infant wrap, 3.0m	C5			
			<b>U810-29M</b>	Multi-site, 3.0m	C5			
			<b>U910-29M</b>	Adult ear clip, 3.0m	C7			
		See M-Tech U*03-49R Series Sensor	2.2m		U708M-29			

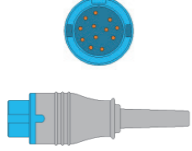







Mindray > Datascope Next Page

OEM Manufacturer & Models	Sensor Connector	REF# OEM	REF# UNIMED	Sensor Descriptions	Price (unit)	Ext - Cable	Monitor End Conn.	Sensor End Conn.
Mindray > Datascope								
PM-6000, PM-8000  (*M-Tech)			<b>U110-30M</b>	Pediatric finger clip, 3.0m	C7	Direct		
			<b>U110S-30M</b>	Pediatric soft tip, 3.0m	C7			
			<b>U210S-30M</b>	Infant soft tip, 3.0m	C7			
			<b>U310-30M</b>	Neonate wrap, 3.0m	C7			
			<b>U410-30M</b>	Adult finger clip, 3.0m	C5			
			<b>U410S-30M</b>	Adult soft tip, 3.0m	C7			
			<b>U610-30M</b>	Adult/Neonate wrap, 3.0m	C5			
			<b>U610B-30M</b>	Pediatric/Infant wrap, 3.0m	C5			
			<b>U810-30M</b>	Multi-site, 3.0m	C5			
			<b>U910-30M</b>	Adult ear clip, 3.0m	C7			
		See M-Tech U*03-49R Series Sensor	2.2m		U708M-30 (115-023136-00)			
DPM4, DPM5, PM 7000, PM 8000, PM 9000, Trio  (*NE-Tech Oximax)			<b>U110-180P</b>	Pediatric finger clip, 3.0m	C8	Direct		
			<b>U110S-180P</b>	Pediatric soft tip, 3.0m	C8			
			<b>U210S-180P</b>	Infant soft tip, 3.0m	C8			
			<b>U310-180P</b>	Neonate wrap, 3.0m	C8			
			<b>U410-180P</b>	Adult finger clip, 3.0m	C7			
			<b>U410S-180P</b>	Adult soft tip, 3.0m	C8			
			<b>U610-180P</b>	Adult/Neonate wrap, 3.0m	C7			
			<b>U610B-180P</b>	Pediatric/Infant wrap, 3.0m	C7			
			<b>U810-180P</b>	Multi-site, 3.0m	C7			
			<b>U910-180P</b>	Adult ear clip, 3.0m	C8			
		See NE-Tech (OxiMax) U*03-01P Series Sensor	2.2m		U708X-180 (0010-20-42595, 571B)			
PM-5000, PM-6000, PM-8000			<b>U110-22</b>	Pediatric finger clip, 3.0m	C8.1	Direct		
			<b>U110S-22</b>	Pediatric soft tip, 3.0m	C8.1			
			<b>U210S-22</b>	Infant soft tip, 3.0m	C8.1			
			<b>U310-22</b>	Neonate wrap, 3.0m	C8.1			
			<b>U410-22</b>	Adult finger clip, 3.0m	C6.7			
			<b>U410S-22</b>	Adult soft tip, 3.0m	C8.1			
			<b>U610-22</b>	Adult/Neonate wrap, 3.0m	C6.7			
			<b>U610B-22</b>	Pediatric/Infant wrap, 3.0m	C6.7			
			<b>U810-22</b>	Multi-site, 3.0m	C6.7			
			<b>U910-22</b>	Adult ear clip, 3.0m	C8.1			
		See NE-Tech (OxiSmart) U*03-01 Series Sensor	2.2m		U708-22 (0515-30-11221)			











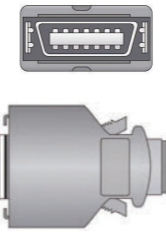

Mindray > Datascope Next Page

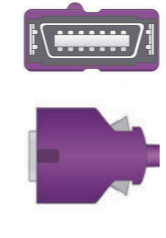









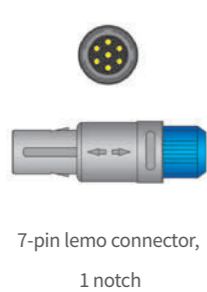
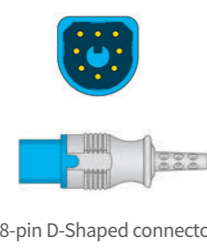

OEM Manufacturer & Models	Sensor Connector	REF# OEM	REF# UNIMED	Sensor Descriptions	Price (unit)	Ext - Cable	Monitor End Conn.	Sensor End Conn.
Mindray > Datascope								
PM-6000 (*M-Tech)			<b>U110-22M</b>	Pediatric finger clip, 3.0m	C8.1	Direct		
			<b>U110S-22M</b>	Pediatric soft tip, 3.0m	C8.1			
			<b>U210S-22M</b>	Infant soft tip, 3.0m	C8.1			
			<b>U310-22M</b>	Neonate wrap, 3.0m	C8.1			
			<b>U410-22M</b>	Adult finger clip, 3.0m	C6.7			
			<b>U410S-22M</b>	Adult soft tip, 3.0m	C8.1			
			<b>U610-22M</b>	Adult/Neonate wrap, 3.0m	C6.7			
			<b>U610B-22M</b>	Pediatric/Infant wrap, 3.0m	C6.7			
			<b>U810-22M</b>	Multi-site, 3.0m	C6.7			
			<b>U910-22M</b>	Adult ear clip, 3.0m	C8.1			
		See M-Tech U*03-49R Series Sensor	2.2m		U708M-22 (0010-30-12452)			
503,507,508,509,PM9000 (*CSI Tech)			<b>U110-05</b>	Pediatric finger clip, 3.0m	D1	Direct		
			<b>U110S-05</b>	Pediatric soft tip, 3.0m	D1			
			<b>U210S-05</b>	Infant soft tip, 3.0m	D1			
			<b>U310-05</b>	Neonate wrap, 3.0m	D1			
			<b>U410-05</b>	Adult finger clip, 3.0m	C8			
			<b>U410S-05</b>	Adult soft tip, 3.0m	D1			
			<b>U610-05</b>	Adult/Neonate wrap, 3.0m	C8			
			<b>U610B-05</b>	Pediatric/Infant wrap, 3.0m	C8			
			<b>U810-05</b>	Multi-site, 3.0m	C8			
			<b>U910-05</b>	Adult ear clip, 3.0m	D1			
500A,509B,PM9000 (*BCI Tech)			<b>U110-31</b>	Pediatric finger clip, 3.0m	D1	Direct		
			<b>U110S-31</b>	Pediatric soft tip, 3.0m	D1			
			<b>U210S-31</b>	Infant soft tip, 3.0m	D1			
			<b>U310-31</b>	Neonate wrap, 3.0m	D1			
			<b>U410-31</b>	Adult finger clip, 3.0m	C8			
			<b>U410S-31</b>	Adult soft tip, 3.0m	D1			
			<b>U610-31</b>	Adult/Neonate wrap, 3.0m	C8			
			<b>U610B-31</b>	Pediatric/Infant wrap, 3.0m	C8			
			<b>U810-31</b>	Multi-site, 3.0m	C8			
			<b>U910-31</b>	Adult ear clip, 3.0m	D1			
BeneVision, BeneView, iPM, iMEC, uMEC series monitors, VS-600/900, BeneHeart defibrillators, DPM 6, DPM 7			<b>U110-48</b>	Pediatric finger clip, 3.0m	C7	Direct		
			<b>U110S-48</b>	Pediatric soft tip, 3.0m	C7			
			<b>U210S-48</b>	Infant soft tip, 3.0m	C7			
			<b>U310-48</b>	Neonate wrap, 3.0m	C7			
			<b>U410-48</b>	Adult finger clip, 3.0m	C5			
			<b>U410S-48</b>	Adult soft tip, 3.0m	C7			
			<b>U610-48</b>	Adult/Neonate wrap, 3.0m	C5			
			<b>U610B-48</b>	Pediatric/Infant wrap, 3.0m	C5			
			<b>U810-48</b>	Multi-site, 3.0m	C5			
			<b>U910-48</b>	Adult ear clip, 3.0m	C7			
		See NE-Tech (OxiSmart) U*03-01 Series Sensor	2.2m		U708-48 (562A/0010-20-42710)			

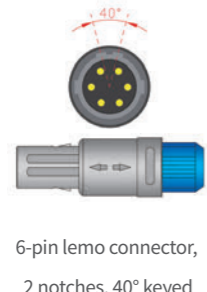
OEM Manufacturer & Models	Sensor Connector	REF# OEM	REF# UNIMED	Sensor Descriptions	Price (unit)	Ext - Cable	Monitor End Conn.	Sensor End Conn.
Mindray > Datascope								
BeneVision, BeneView, iPM, iMEC series monitors, VS-600/900, BeneHeart defibrillators, DPM 6, DPM 7, Accutorr 3, Accutorr 7, Passport 8, Passport 12, T1 (*NE-Tech OxiMax)			<b>U110-48P</b>	Pediatric finger clip, 3.0m	C8	Direct		
			<b>U110S-48P</b>	Pediatric soft tip, 3.0m	C8			
			<b>U210S-48P</b>	Infant soft tip, 3.0m	C8			
			<b>U310-48P</b>	Neonate wrap, 3.0m	C8			
			<b>U410-48P</b>	Adult finger clip, 3.0m	C7			
			<b>U410S-48P</b>	Adult soft tip, 3.0m	C8			
			<b>U610-48P</b>	Adult/Neonate wrap, 3.0m	C7			
			<b>U610B-48P</b>	Pediatric/Infant wrap, 3.0m	C7			
			<b>U810-48P</b>	Multi-site, 3.0m	C7			
			<b>U910-48P</b>	Adult ear clip, 3.0m	C8			
		See NE-Tech (OxiMax) U*03-01P Series Sensor	2.2m		U708X-48 (0010-20-42712)			
DPM 6, DPM 7, Accutorr 3, Accutorr 7, Passport 8, Passport 12, T1, Accutorr 3, Accutorr 7, BeneView T1, BeneView T5, BeneView T8, Beneheart D6, MEC 12, MPM, PM 6800 (*M-Tech Rainbow)			<b>U110-48MR</b>	Pediatric finger clip, 3.0m	D1	Direct		
			<b>U110S-48MR</b>	Pediatric soft tip, 3.0m	D1			
			<b>U210S-48MR</b>	Infant soft tip, 3.0m	D1			
			<b>U310-48MR</b>	Neonate wrap, 3.0m	D1			
			<b>U410-48MR</b>	Adult finger clip, 3.0m	C8			
			<b>U410S-48MR</b>	Adult soft tip, 3.0m	D1			
			<b>U610-48MR</b>	Adult/Neonate wrap, 3.0m	C8			
			<b>U610B-48MR</b>	Pediatric/Infant wrap, 3.0m	C8			
			<b>U810-48MR</b>	Multi-site, 3.0m	C8			
			<b>U910-48MR</b>	Adult ear clip, 3.0m	D1			
		See M-Tech U*03-49R Series Sensor	2.2m		U708M-48R (040-00332-00)			
DPM 6, DPM 7 (*M-Tech)			<b>U110-48M</b>	Pediatric finger clip, 3.0m	C8.1	Direct		
			<b>U110S-48M</b>	Pediatric soft tip, 3.0m	C8.1			
			<b>U210S-48M</b>	Infant soft tip, 3.0m	C8.1			
			<b>U310-48M</b>	Neonate wrap, 3.0m	C8.1			
			<b>U410-48M</b>	Adult finger clip, 3.0m	C6.7			
			<b>U410S-48M</b>	Adult soft tip, 3.0m	C8.1			
			<b>U610-48M</b>	Adult/Neonate wrap, 3.0m	C6.7			
			<b>U610B-48M</b>	Pediatric/Infant wrap, 3.0m	C6.7			
			<b>U810-48M</b>	Multi-site, 3.0m	C6.7			
			<b>U910-48M</b>	Adult ear clip, 3.0m	C8.1			
		See M-Tech U*03-49R Series Sensor	2.2m		U708M-48 (115-023135-00)			

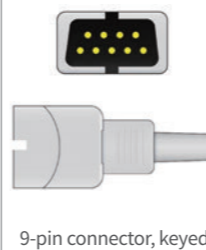

OEM Manufacturer & Models	Sensor Connector	REF# OEM	REF# UNIMED	Sensor Descriptions	Price (unit)	Ext - Cable	Monitor End Conn.	Sensor End Conn.
<b>M&amp;B/Mbelec</b>								
MB526,MB526+ MB526T8,MB526T12 MB526+tw,MB800 CD2000,CD2000+			<b>U110-92</b>	Pediatric finger clip, 3.0m	C8	Direct		
			<b>U110S-92</b>	Pediatric soft tip, 3.0m	C8			
			<b>U210S-92</b>	Infant soft tip, 3.0m	C8			
			<b>U310-92</b>	Neonate wrap, 3.0m	C8			
			<b>U410-92</b>	Adult finger clip, 3.0m	C7			
			<b>U410S-92</b>	Adult soft tip, 3.0m	C8			
			<b>U610-92</b>	Adult/Neonate wrap, 3.0m	C7			
			<b>U610B-92</b>	Pediatric/Infant wrap, 3.0m	C7			
			<b>U810-92</b>	Multi-site, 3.0m	C7			
	<b>U910-92</b>	Adult ear clip, 3.0m	C8					
		See NE-Tech (OxiSmart) U*03-01 Series Sensor	2.2m		U708-92			
CD2000,CD2000+ (*NE-Tech OxiMax)			<b>U110-92P</b>	Pediatric finger clip, 3.0m	D1	Direct		
			<b>U110S-92P</b>	Pediatric soft tip, 3.0m	D1			
			<b>U210S-92P</b>	Infant soft tip, 3.0m	D1			
			<b>U310-92P</b>	Neonate wrap, 3.0m	D1			
			<b>U410-92P</b>	Adult finger clip, 3.0m	C8			
			<b>U410S-92P</b>	Adult soft tip, 3.0m	D1			
			<b>U610-92P</b>	Adult/Neonate wrap, 3.0m	C8			
			<b>U610B-92P</b>	Pediatric/Infant wrap, 3.0m	C8			
			<b>U810-92P</b>	Multi-site, 3.0m	C8			
	<b>U910-92P</b>	Adult ear clip, 3.0m	D1					
		See NE-Tech (OxiMax) U*03-01P Series Sensor	2.2m		U708X-92			
<b>NE-Tech</b>								
N-10, N-100, N-180, N-190, N-20, N-200, N-30, N-3000, N-390, N-395, N-6000, NPB-190, NPB-195, NPB-290, NPB-295, NPB-3910, NPB-3920, NPB-3930, NPB-3940, NPB-40, NPB-4000, NPB-75, Symphony N-3000 (*NE-Tech OxiSmart)			<b>U103-01</b>	Pediatric finger clip, 1.1m	C5	Direct		
			<b>U103S-01</b>	Pediatric soft tip, 1.1m	C5			
			<b>U203S-01</b>	Infant soft tip, 1.1m	C5			
			<b>U303-01</b>	Neonate wrap, 1.1m	C5			
			<b>U403-01</b>	Adult finger clip, 1.1m	C3.8			
			<b>U403S-01</b>	Adult soft tip, 1.1m	C5			
			<b>U603-01</b>	Adult/Neonate wrap, 1.1m	C3.8			
			<b>U603B-01</b>	Pediatric/Infant wrap, 1.1m	C3.8			
			<b>U803-01</b>	Multi-site, 1.1m	C3.8			
			<b>U903-01</b>	Adult ear clip, 1.1m	C5			
			<b>U903N-01</b>	Adult ear clip(New Style), 1.1m	C4			
		N-10, N-180, N-190, N-20, N-30, N-560, N-600, N-600x, N-65, N-85, NPB-190, NPB-195, NPB-3910, NPB-3920, NPB-3930, NPB-3940, NPB-40, NPB-4000, NPB-75, PM100N, PM10N (*NE-Tech OxiMax)			<b>U103-01P</b>			
FlexMax-P	<b>U103S-01P</b>			Pediatric soft tip, 1.1m	C7			
	<b>U203S-01P</b>			Infant soft tip, 1.1m	C7			
	<b>U303-01P</b>			Neonate wrap, 1.1m	C7			
DS-100A	<b>U403-01P</b>			Adult finger clip, 1.1m	C5			
FlexMax	<b>U403S-01P</b>			Adult soft tip, 1.1m	C7			
Oxi-A/N	<b>U603-01P</b>			Adult/Neonate wrap, 1.1m	C5			
Oxi-P/I	<b>U603B-01P</b>			Pediatric/Infant wrap, 1.1m	C5			
D-Y/S	<b>U803-01P</b>			Multi-site, 1.1m	C5			
D-YSE	<b>U903-01P</b>			Adult ear clip, 1.1m	C7			



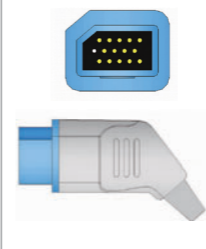
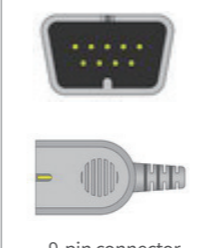



OEM Manufacturer & Models	Sensor Connector	REF# OEM	REF# UNIMED	Sensor Descriptions	Price (unit)	Ext - Cable	Monitor End Conn.	Sensor End Conn.
<b>NE-Tech</b>								
N-3000, N-390, N-395, N-6000, NPB-290, NPB-295, Symphony N-3000			<b>U110-69</b>	Pediatric finger clip, 3.0m	D1	Direct		
			<b>U110S-69</b>	Pediatric soft tip, 3.0m	D1			
			<b>U210S-69</b>	Infant soft tip, 3.0m	D1			
			<b>U310-69</b>	Neonate wrap, 3.0m	D1			
			<b>U410-69</b>	Adult finger clip, 3.0m	C8			
			<b>U410S-69</b>	Adult soft tip, 3.0m	D1			
			<b>U610-69</b>	Adult/Neonate wrap, 3.0m	C8			
			<b>U610B-69</b>	Pediatric/Infant wrap, 3.0m	C8			
			<b>U810-69</b>	Multi-site, 3.0m	C8			
	<b>U910-69</b>	Adult ear clip, 3.0m	D1					
		See NE-Tech (OxiSmart) U*03-01 Series Sensor	3.0m		U710-69 (SCP-10/MC-10)			
N-3000, N-390, N-395, N-550, N-560, N-595, N-600, N-6000, N-600x, NPB-290, NPB-295 (*NE-Tech OxiMax)			<b>U110-70P</b>	Pediatric finger clip, 3.0m	D2	Direct		
			<b>U110S-70P</b>	Pediatric soft tip, 3.0m	D2			
			<b>U210S-70P</b>	Infant soft tip, 3.0m	D2			
			<b>U310-70P</b>	Neonate wrap, 3.0m	D2			
			<b>U410-70P</b>	Adult finger clip, 3.0m	D1			
			<b>U410S-70P</b>	Adult soft tip, 3.0m	D2			
			<b>U610-70P</b>	Adult/Neonate wrap, 3.0m	D1			
			<b>U610B-70P</b>	Pediatric/Infant wrap, 3.0m	D1			
			<b>U810-70P</b>	Multi-site, 3.0m	D1			
	<b>U910-70P</b>	Adult ear clip, 3.0m	D2					
		See NE-Tech (OxiMax) U*03-01P Series Sensor	3.0m		U710-70 (DOC-10)			
<b>Neusoft</b>								
NSC Series (*NE-Tech OxiMax)			<b>U110-78P</b>	Pediatric finger clip, 3.0m	D1	Direct		
			<b>U110S-78P</b>	Pediatric soft tip, 3.0m	D1			
			<b>U210S-78P</b>	Infant soft tip, 3.0m	D1			
			<b>U310-78P</b>	Neonate wrap, 3.0m	D1			
			<b>U410-78P</b>	Adult finger clip, 3.0m	C8			
			<b>U410S-78P</b>	Adult soft tip, 3.0m	D1			
			<b>U610-78P</b>	Adult/Neonate wrap, 3.0m	C8			
			<b>U610B-78P</b>	Pediatric/Infant wrap, 3.0m	C8			
			<b>U810-78P</b>	Multi-site, 3.0m	C8			
	<b>U910-78P</b>	Adult ear clip, 3.0m	D1					
		See NE-Tech (OxiMax) U*03-01P Series Sensor	3.0m		U710X-78			



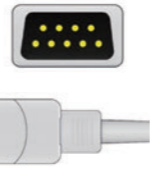

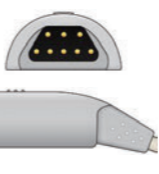
OEM Manufacturer & Models	Sensor Connector	REF# OEM	REF# UNIMED	Sensor Descriptions	Price (unit)	Ext - Cable	Monitor End Conn.	Sensor End Conn.
<b>Neusoft</b>								
Compatible with M-Tech 14-pin connector (*M-Tech Rainbow)			<b>U110-107</b>	Pediatric finger clip, 3.0m	C8	Direct		
			<b>U110S-107</b>	Pediatric soft tip, 3.0m	C8			
			<b>U210S-107</b>	Infant soft tip, 3.0m	C8			
			<b>U310-107</b>	Neonate wrap, 3.0m	C8			
			<b>U410-107</b>	Adult finger clip, 3.0m	C7			
			<b>U410S-107</b>	Adult soft tip, 3.0m	C8			
			<b>U610-107</b>	Adult/Neonate wrap, 3.0m	C7			
			<b>U610B-107</b>	Pediatric/Infant wrap, 3.0m	C7			
			<b>U810-107</b>	Multi-site, 3.0m	C7			
			<b>U910-107</b>	Adult ear clip, 3.0m	C8			
<b>Newtech</b>								
NT2A,NT2C (*Digital Tech)			<b>U110-165D</b>	Pediatric finger clip, 3.0m	D1	Direct		
			<b>U110S-165D</b>	Pediatric soft tip, 3.0m	D1			
			<b>U210S-165D</b>	Infant soft tip, 3.0m	D1			
			<b>U310-165D</b>	Neonate wrap, 3.0m	D1			
			<b>U410-165D</b>	Adult finger clip, 3.0m	C8			
			<b>U410S-165D</b>	Adult soft tip, 3.0m	D1			
			<b>U610-165D</b>	Adult/Neonate wrap, 3.0m	C8			
			<b>U610B-165D</b>	Pediatric/Infant wrap, 3.0m	C8			
			<b>U810-165D</b>	Multi-site, 3.0m	C8			
			<b>U910-165D</b>	Adult ear clip, 3.0m	D1			
NT3A,NT3B,NT3E,NT3F, NT3B60 (*Digital Tech)			<b>U110-173D</b>	Pediatric finger clip, 3.0m	D1	Direct		
			<b>U110S-173D</b>	Pediatric soft tip, 3.0m	D1			
			<b>U210S-173D</b>	Infant soft tip, 3.0m	D1			
			<b>U310-173D</b>	Neonate wrap, 3.0m	D1			
			<b>U410-173D</b>	Adult finger clip, 3.0m	C8			
			<b>U410S-173D</b>	Adult soft tip, 3.0m	D1			
			<b>U610-173D</b>	Adult/Neonate wrap, 3.0m	C8			
			<b>U610B-173D</b>	Pediatric/Infant wrap, 3.0m	C8			
			<b>U810-173D</b>	Multi-site, 3.0m	C8			
			<b>U910-173D</b>	Adult ear clip, 3.0m	D1			
		See Digital Tech U*03-42D Series Sensor	2.2m		U708-173			
(*Digital Tech)			<b>U110-65D</b>	Pediatric finger clip, 3.0m	C8	Direct		
			<b>U110S-65D</b>	Pediatric soft tip, 3.0m	C8			
			<b>U210S-65D</b>	Infant soft tip, 3.0m	C8			
			<b>U310-65D</b>	Neonate wrap, 3.0m	C8			
			<b>U410-65D</b>	Adult finger clip, 3.0m	C7			
			<b>U410S-65D</b>	Adult soft tip, 3.0m	C8			
			<b>U610-65D</b>	Adult/Neonate wrap, 3.0m	C7			
			<b>U610B-65D</b>	Pediatric/Infant wrap, 3.0m	C7			
			<b>U810-65D</b>	Multi-site, 3.0m	C7			
			<b>U910-65D</b>	Adult ear clip, 3.0m	C8			
		See Digital Tech U*03-42D Series Sensor	2.2m		U708-65			

OEM Manufacturer & Models	Sensor Connector	REF# OEM	REF# UNIMED	Sensor Descriptions	Price (unit)	Ext - Cable	Monitor End Conn.	Sensor End Conn.
<b>Newtech</b>								
NT1A,NT1B,NT1D (*Digital Tech Sensor)			<b>U103-42D</b>	Pediatric finger clip , 1.1m	C7	Direct		
			<b>U103S-42D</b>	Pediatric soft tip , 1.1m	C7			
			<b>U203S-42D</b>	Infant soft tip , 1.1m	C7			
			<b>U303-42D</b>	Neonate wrap , 1.1m	C7			
			<b>U403-42D</b>	Adult finger clip , 1.1m	C5			
			<b>U403S-42D</b>	Adult soft tip , 1.1m	C7			
			<b>U603-42D</b>	Adult/Neonate wrap , 1.1m	C5			
			<b>U603B-42D</b>	Pediatric/Infant wrap , 1.1m	C5			
			<b>U803-42D</b>	Multi-site , 1.1m	C5			
			<b>U903-42D</b>	Adult ear clip , 1.1m	C7			
NT3A,NT3B,NT3E,NT3F, NT3B60			<b>U110-167</b>	Pediatric finger clip, 3.0m	C8	Direct		
			<b>U110S-167</b>	Pediatric soft tip, 3.0m	C8			
			<b>U210S-167</b>	Infant soft tip, 3.0m	C8			
			<b>U310-167</b>	Neonate wrap, 3.0m	C8			
			<b>U410-167</b>	Adult finger clip, 3.0m	C7			
			<b>U410S-167</b>	Adult soft tip, 3.0m	C8			
			<b>U610-167</b>	Adult/Neonate wrap, 3.0m	C7			
			<b>U610B-167</b>	Pediatric/Infant wrap, 3.0m	C7			
			<b>U810-167</b>	Multi-site, 3.0m	C7			
			<b>U910-167</b>	Adult ear clip, 3.0m	C8			
		See NE-Tech (OxiSmart) U*03-01 Series Sensor	2.2m		U708-167			
<b>Nihon Kohden</b>								
2303 Life Scope I, 2353 Life Scope L, 4103, 4111, 4113 4114A, 5135, BSM-2301, BSM-2351, BSM-4101, BSM-4102, BSM-4102A, BSM-5105, BSM-6000, BSM-9101, Life Scope A, Life Scope J, Life Scope P, PVM-2701 (* Nihon Kohden Tech)			<b>U110-36</b>	Pediatric finger clip, 3.0m	D1	Direct		
			<b>U110S-36</b>	Pediatric soft tip, 3.0m	D1			
			<b>U210S-36</b>	Infant soft tip, 3.0m	D1			
			<b>U310-36</b>	Neonate wrap, 3.0m	D1			
			<b>U410-36</b>	Adult finger clip, 3.0m	C8			
			<b>U410S-36</b>	Adult soft tip, 3.0m	D1			
			<b>U610-36</b>	Adult/Neonate wrap, 3.0m	C8			
			<b>U610B-36</b>	Pediatric/Infant wrap, 3.0m	C8			
			<b>U810-36</b>	Multi-site, 3.0m	C8			
			<b>U910-36</b>	Adult ear clip, 3.0m	D1			
TL-201T, TL-101T, P224A, P225F TL-220T			<b>U105-16</b>	Pediatric finger clip, 1.5m	C8.2	U710-36 (JL-900P)		
			<b>U105S-16</b>	Pediatric soft tip, 1.5m	C8.2			
			<b>U205S-16</b>	Infant soft tip, 1.5m	C8.2			
			<b>U305-16</b>	Neonate wrap, 1.5m	C8.2			
			<b>U405-16</b>	Adult finger clip, 1.5m	C7			
			<b>U405S-16</b>	Adult soft tip, 1.5m	C8.2			
			<b>U605-16</b>	Adult/Neonate wrap, 1.5m	C7			
			<b>U605B-16</b>	Pediatric/Infant wrap, 1.5m	C7			
			<b>U805-16</b>	Multi-site, 1.5m	C7			
			<b>U905-16</b>	Adult ear clip, 1.5m	C8.2			



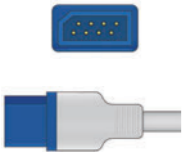

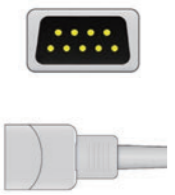

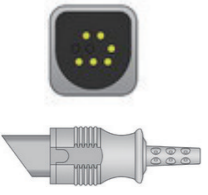

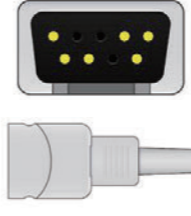
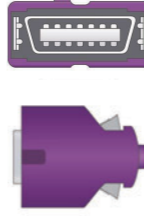

OEM Manufacturer & Models	Sensor Connector	REF# OEM	REF# UNIMED	Sensor Descriptions	Price (unit)	Ext - Cable	Monitor End Conn.	Sensor End Conn.
Nihon Kohden								
Life Scope N, OLV-2700k, OPV-1500  (* Nihon Kohden Tech)			<b>U110-106</b>	Pediatric finger clip, 3.0m	C8	Direct		
			<b>U110S-106</b>	Pediatric soft tip, 3.0m	C8			
			<b>U210S-106</b>	Infant soft tip, 3.0m	C8			
			<b>U310-106</b>	Neonate wrap, 3.0m	C8			
			<b>U410-106</b>	Adult finger clip, 3.0m	C7			
			<b>U410S-106</b>	Adult soft tip, 3.0m	C8			
			<b>U610-106</b>	Adult/Neonate wrap, 3.0m	C7			
			<b>U610B-106</b>	Pediatric/Infant wrap, 3.0m	C7			
			<b>U810-106</b>	Multi-site, 3.0m	C7			
			<b>U910-106</b>	Adult ear clip, 3.0m	C8			
		See Nihon Kohden U*05-16 Series Sensor	3.0m		U710-106 (JL-302T)			
BSM-1101 Life Scope EC, BSM-2101/2 Life Scope L, BSM-3101 Life Scope LC, BSM-7100/7200 Life Scope 8, BSM-8200/1 Life Scope 12, BSM-8301/2 Life Scope 9, NT3B, OLV-1100A, SM-8800 Life Scope 14  (* Nihon Kohden Tech)			<b>U110-16</b>	Pediatric finger clip, 3.0m	C8	Direct		
			<b>U110S-16</b>	Pediatric soft tip, 3.0m	C8			
			<b>U210S-16</b>	Infant soft tip, 3.0m	C8			
			<b>U310-16</b>	Neonate wrap, 3.0m	C8			
			<b>U410-16</b>	Adult finger clip, 3.0m	C7			
			<b>U410S-16</b>	Adult soft tip, 3.0m	C8			
			<b>U610-16</b>	Adult/Neonate wrap, 3.0m	C7			
			<b>U610B-16</b>	Pediatric/Infant wrap, 3.0m	C7			
			<b>U810-16</b>	Multi-site, 3.0m	C7			
			<b>U910-16</b>	Adult ear clip, 3.0m	C8			
		See Nihon Kohden U*05-16 Series Sensor	2.2m		U708-16			
SVM-7501 SVM-7503 SVM-7521 SVM 7600 Series  (* Nihon Kohden Tech)			<b>U110-224</b>	Pediatric finger clip, 3.0m	D1	Direct		
			<b>U110S-224</b>	Pediatric soft tip, 3.0m	D1			
			<b>U210S-224</b>	Infant soft tip, 3.0m	D1			
			<b>U310-224</b>	Neonate wrap, 3.0m	D1			
			<b>U410-224</b>	Adult finger clip, 3.0m	C8			
			<b>U410S-224</b>	Adult soft tip, 3.0m	D1			
			<b>U610-224</b>	Adult/Neonate wrap, 3.0m	C8			
			<b>U610B-224</b>	Pediatric/Infant wrap, 3.0m	C8			
			<b>U810-224</b>	Multi-site, 3.0m	C8			
			<b>U910-224</b>	Adult ear clip, 3.0m	D1			
		See Nihon Kohden U*05-16 Series Sensor	2.2m		U708-224 (SLZ106/JL-701P)			



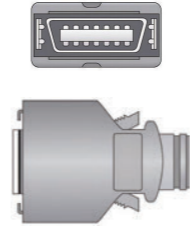



OEM Manufacturer & Models	Sensor Connector	REF# OEM	REF# UNIMED	Sensor Descriptions	Price (unit)	Ext - Cable	Monitor End Conn.	Sensor End Conn.
Nonin								
2120, 2500, 2500A, 7500, 8000Q, 8500, 8550, 8600, 8700, 8800, 9600, 9700, 9840, 9843, 9847V, Xpod 3012, Xpod 3012LP  (* Nonin Tech)		8000AP	<b>U103-08</b>	Pediatric finger clip , 1.1m	C5	U708-08L		
		8000SM	<b>U103S-08</b>	Pediatric soft tip , 1.1m	C5			
		8000SS	<b>U203S-08</b>	Infant soft tip , 1.1m	C5			
			<b>U303-08</b>	Neonate wrap , 1.1m	C5			
		8000AA	<b>U403-08</b>	Adult finger clip , 1.1m	C3.8			
		8000SL	<b>U403S-08</b>	Adult soft tip , 1.1m	C5			
		8000J	<b>U603-08</b>	Adult/Neonate wrap , 1.1m	C3.8			
			<b>U603B-08</b>	Pediatric/Infant wrap , 1.1m	C3.8			
			<b>U803-08</b>	Multi-site , 1.1m	C3.8			
			<b>U903-08</b>	Adult ear clip , 1.1m	C5			
			<b>U110-08L</b>	Pediatric finger clip, 3.0m	C7			
			<b>U110S-08L</b>	Pediatric soft tip, 3.0m	C7			
			<b>U210S-08L</b>	Infant soft tip, 3.0m	C7			
			<b>U305-08L</b>	Neonate wrap, 1.5m	C6			
	<b>U310-08L</b>	Neonate wrap, 3.0m	C7					
	<b>U410-08L</b>	Adult finger clip, 3.0m	C5					
	<b>U410S-08L</b>	Adult soft tip, 3.0m	C7					
	<b>U610-08L</b>	Adult/Neonate wrap, 3.0m	C5					
	<b>U610B-08L</b>	Pediatric/Infant wrap, 3.0m	C5					
	<b>U810-08L</b>	Multi-site, 3.0m	C5					
	<b>U910-08L</b>	Adult ear clip, 3.0m	C7					
Avant 4000			<b>U101-146</b>	Pediatric finger clip , 0.3m	D1	Direct		
			<b>U101S-146</b>	Pediatric soft tip , 0.3m	D1			
			<b>U201S-146</b>	Infant soft tip , 0.3m	D1			
			<b>U301-146</b>	Neonate wrap , 0.3m	D1			
			<b>U401-146</b>	Adult finger clip , 0.3m	C8			
			<b>U401S-146</b>	Adult soft tip , 0.3m	D1			
			<b>U601-146</b>	Adult/Neonate wrap , 0.3m	C8			
			<b>U601B-146</b>	Pediatric/Infant wrap , 0.3m	C8			
			<b>U801-146</b>	Multi-site , 0.3m	C8			
			<b>U901-146</b>	Adult ear clip , 0.3m	D1			
8604  (* Nonin Tech)			<b>U110-08</b>	Pediatric finger clip, 3.0m	D1	Direct		
			<b>U110S-08</b>	Pediatric soft tip, 3.0m	D1			
			<b>U210S-08</b>	Infant soft tip, 3.0m	D1			
			<b>U310-08</b>	Neonate wrap, 3.0m	D1			
			<b>U410-08</b>	Adult finger clip, 3.0m	C8			
			<b>U410S-08</b>	Adult soft tip, 3.0m	D1			
			<b>U610-08</b>	Adult/Neonate wrap, 3.0m	C8			
			<b>U610B-08</b>	Pediatric/Infant wrap, 3.0m	C8			
			<b>U810-08</b>	Multi-site, 3.0m	C8			
			<b>U910-08</b>	Adult ear clip, 3.0m	D1			
		See Nonin U*03-08 Series Sensor	2.2m		U708-08			



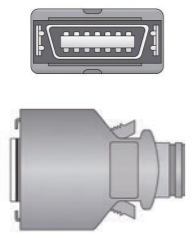

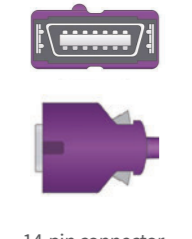

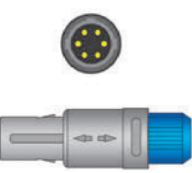
OEM Manufacturer & Models	Sensor Connector	REF# OEM	REF# UNIMED	Sensor Descriptions	Price (unit)	Ext - Cable	Monitor End Conn.	Sensor End Conn.
Northern Meditec								
Gemini, Taurus, Virgo, Aquarius	 8-pin connector, keyed		U110-227	Pediatric finger clip, 3.0m	D1.3	Direct		
			U110S-227	Pediatric soft tip, 3.0m	D1.3			
			U210S-227	Infant soft tip, 3.0m	D1.3			
			U310-227	Neonate wrap, 3.0m	D1.3			
			U410-227	Adult finger clip, 3.0m	C8.7			
			U410S-227	Adult soft tip, 3.0m	D1.3			
			U610-227	Adult/Neonate wrap, 3.0m	C8.7			
			U610B-227	Pediatric/Infant wrap, 3.0m	C8.7			
			U810-227	Multi-site, 3.0m	C8.7			
			U910-227	Adult ear clip, 3.0m	D1.3			
Novamatrix								
2001, 500, 505, 510, 511, 515, 515A, 515B, 515C, 520, 520A, 7000, 7100, 7200, 7300, Oxypleth  (*Novamatrix Tech)	 7-pin connector, keyed		U110-03	Pediatric finger clip, 3.0m	C8	Direct		
			U110S-03	Pediatric soft tip, 3.0m	C8			
			U210S-03	Infant soft tip, 3.0m	C8			
			U310-03	Neonate wrap, 3.0m	C8			
			U410-03	Adult finger clip, 3.0m	C7			
			U410S-03	Adult soft tip, 3.0m	C8			
			U610-03	Adult/Neonate wrap, 3.0m	C7			
			U610B-03	Pediatric/Infant wrap, 3.0m	C7			
			U810-03	Multi-site, 3.0m	C7			
			U910-03	Adult ear clip, 3.0m	C8			
	 9-pin connector		U103-03	Pediatric finger clip, 1.1m	C7	U708-03		
		U103S-03	Pediatric soft tip, 1.1m	C7				
		U203S-03	Infant soft tip, 1.1m	C7				
		U303-03	Neonate wrap, 1.1m	C7				
		U403-03	Adult finger clip, 1.1m	C5				
		U403S-03	Adult soft tip, 1.1m	C7				
		U603-03	Adult/Neonate wrap, 1.1m	C5				
		U603B-03	Pediatric/Infant wrap, 1.1m	C5				
		U803-03	Multi-site, 1.1m	C5				
		U903-03	Adult ear clip, 1.1m	C7				
Gemini, Taurus, Virgo, Aquarius	 6-pin connector		U103-103	Pediatric finger clip, 1.1m	C8	Direct		
			U103S-103	Pediatric soft tip, 1.1m	C8			
			U203S-103	Infant soft tip, 1.1m	C8			
			U303-103	Neonate wrap, 1.1m	C8			
			U403-103	Adult finger clip, 1.1m	C7			
			U403S-103	Adult soft tip, 1.1m	C8			
			U603-103	Adult/Neonate wrap, 1.1m	C7			
			U603B-103	Pediatric/Infant wrap, 1.1m	C7			
			U803-103	Multi-site, 1.1m	C7			
			U903-103	Adult ear clip, 1.1m	C8			

Novamatrix Next Page



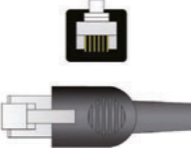









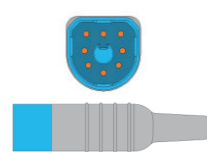

OEM Manufacturer & Models	Sensor Connector	REF# OEM	REF# UNIMED	Sensor Descriptions	Price (unit)	Ext - Cable	Monitor End Conn.	Sensor End Conn.
Novamatrix								
512, 513, 710, 715, MARS  (*Novamatrix Tech)	 6-pin connector, Keyed		U103-73	Pediatric finger clip, 1.1m	C6	Direct		
			U103S-73	Pediatric soft tip, 1.1m	C6			
			U203S-73	Infant soft tip, 1.1m	C6			
			U303-73	Neonate wrap, 1.1m	C6			
			U403-73	Adult finger clip, 1.1m	C5			
			U403S-73	Adult soft tip, 1.1m	C6			
			U603-73	Adult/Neonate wrap, 1.1m	C5			
			U603B-73	Pediatric/Infant wrap, 1.1m	C5			
			U803-73	Multi-site, 1.1m	C5			
			U903-73	Adult ear clip, 1.1m	C6			
Omron > Colin								
BX-10NE  (*NE-Tech OxiMax)	 14-pin connector		U110-70P	Pediatric finger clip, 3.0m	D2	Direct		
			U110S-70P	Pediatric soft tip, 3.0m	D2			
			U210S-70P	Infant soft tip, 3.0m	D2			
			U310-70P	Neonate wrap, 3.0m	D2			
			U410-70P	Adult finger clip, 3.0m	D1			
			U410S-70P	Adult soft tip, 3.0m	D2			
			U610-70P	Adult/Neonate wrap, 3.0m	D1			
			U610B-70P	Pediatric/Infant wrap, 3.0m	D1			
			U810-70P	Multi-site, 3.0m	D1			
			U910-70P	Adult ear clip, 3.0m	D2			
	 9-pin connector, Keyed		See NE-Tech (OxiMax) U*03-01P Series Sensor	2.2m		U708-70		
BP-88S	 14-pin connector, keyed		U110-69	Pediatric finger clip, 3.0m	D1	Direct		
			U110S-69	Pediatric soft tip, 3.0m	D1			
			U210S-69	Infant soft tip, 3.0m	D1			
			U310-69	Neonate wrap, 3.0m	D1			
			U410-69	Adult finger clip, 3.0m	C8			
			U410S-69	Adult soft tip, 3.0m	D1			
			U610-69	Adult/Neonate wrap, 3.0m	C8			
			U610B-69	Pediatric/Infant wrap, 3.0m	C8			
			U810-69	Multi-site, 3.0m	C8			
			U910-69	Adult ear clip, 3.0m	D1			
	 9-pin connector, Keyed		See NE-Tech (OxiSmart) U*03-01 Series Sensor	3.0m		U710-69		

Omron > Colin Next Page











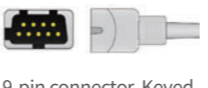



OEM Manufacturer & Models	Sensor Connector	REF# OEM	REF# UNIMED	Sensor Descriptions	Price (unit)	Ext - Cable	Monitor End Conn.	Sensor End Conn.
<b>Omron &gt; Colin</b>								
BP308,BP408,BX-5,BX-10MA  (*M-Tech)	 14-pin connector		<b>U110-15R</b>	Pediatric finger clip, 3.0m	D1	Direct		
			<b>U110S-15R</b>	Pediatric soft tip, 3.0m	D1			
			<b>U210S-15R</b>	Infant soft tip, 3.0m	D1			
			<b>U310-15R</b>	Neonate wrap, 3.0m	D1			
			<b>U410-15R</b>	Adult finger clip, 3.0m	C8			
			<b>U410S-15R</b>	Adult soft tip, 3.0m	D1			
			<b>U610-15R</b>	Adult/Neonate wrap, 3.0m	C8			
			<b>U610B-15R</b>	Pediatric/Infant wrap, 3.0m	C8			
			<b>U810-15R</b>	Multi-site, 3.0m	C8			
			<b>U910-15R</b>	Adult ear clip, 3.0m	D1			
			 9-pin connector, Keyed	See M-Tech U*03-49R Series Sensor	2.2m			
<b>Oridion</b>								
Capnostream 20  (*NE-Tech OxiMax)	 14-pin connector		<b>U110-70P</b>	Pediatric finger clip, 3.0m	D2	Direct		
			<b>U110S-70P</b>	Pediatric soft tip, 3.0m	D2			
			<b>U210S-70P</b>	Infant soft tip, 3.0m	D2			
			<b>U310-70P</b>	Neonate wrap, 3.0m	D2			
			<b>U410-70P</b>	Adult finger clip, 3.0m	D1			
			<b>U410S-70P</b>	Adult soft tip, 3.0m	D2			
			<b>U610-70P</b>	Adult/Neonate wrap, 3.0m	D1			
			<b>U610B-70P</b>	Pediatric/Infant wrap, 3.0m	D1			
			<b>U810-70P</b>	Multi-site, 3.0m	D1			
			<b>U910-70P</b>	Adult ear clip, 3.0m	D2			
			 9-pin connector, Keyed	See NE-Tech (OxiMax) U*03-01P Series Sensor	2.2m			
<b>Osen</b>								
9000  (*BCI Tech)	 6-pin lemo connector, 1 notch		<b>U110-96</b>	Pediatric finger clip, 3.0m	C8	Direct		
			<b>U110S-96</b>	Pediatric soft tip, 3.0m	C8			
			<b>U210S-96</b>	Infant soft tip, 3.0m	C8			
			<b>U310-96</b>	Neonate wrap, 3.0m	C8			
			<b>U410-96</b>	Adult finger clip, 3.0m	C7			
			<b>U410S-96</b>	Adult soft tip, 3.0m	C8			
			<b>U610-96</b>	Adult/Neonate wrap, 3.0m	C7			
			<b>U610B-96</b>	Pediatric/Infant wrap, 3.0m	C7			
			<b>U810-96</b>	Multi-site, 3.0m	C7			
			<b>U910-96</b>	Adult ear clip, 3.0m	C8			
			 9-pin connector	See BCI U*03-06 Series Sensor	2.2m			

OEM Manufacturer & Models	Sensor Connector	REF# OEM	REF# UNIMED	Sensor Descriptions	Price (unit)	Ext - Cable	Monitor End Conn.	Sensor End Conn.
<b>PaceTech</b>								
Model 520 with black face except for Vitalmax 800w	 5-pin connector, 1 notch		<b>U110-39</b>	Pediatric finger clip, 3.0m	D2	Direct		
			<b>U110S-39</b>	Pediatric soft tip, 3.0m	D2			
			<b>U210S-39</b>	Infant soft tip, 3.0m	D2			
			<b>U310-39</b>	Neonate wrap, 3.0m	D2			
			<b>U410-39</b>	Adult finger clip, 3.0m	D1			
			<b>U410S-39</b>	Adult soft tip, 3.0m	D2			
			<b>U610-39</b>	Adult/Neonate wrap, 3.0m	D1			
			<b>U610B-39</b>	Pediatric/Infant wrap, 3.0m	D1			
			<b>U810-39</b>	Multi-site, 3.0m	D1			
			<b>U910-39</b>	Adult ear clip, 3.0m	D2			
			 9-pin connector, Keyed	See NE-Tech (OxiSmart) U*03-01 Series Sensor	2.2m			
<b>Palco</b>								
ALL	 6-pin connector, keyed		<b>U110-18</b>	Pediatric finger clip, 3.0m	C8	Direct		
			<b>U110S-18</b>	Pediatric soft tip, 3.0m	C8			
			<b>U210S-18</b>	Infant soft tip, 3.0m	C8			
			<b>U310-18</b>	Neonate wrap, 3.0m	C8			
			<b>U410-18</b>	Adult finger clip, 3.0m	C7			
			<b>U410S-18</b>	Adult soft tip, 3.0m	C8			
			<b>U610-18</b>	Adult/Neonate wrap, 3.0m	C7			
			<b>U610B-18</b>	Pediatric/Infant wrap, 3.0m	C7			
			<b>U810-18</b>	Multi-site, 3.0m	C7			
			<b>U910-18</b>	Adult ear clip, 3.0m	C8			
		M30/40,M100,M130, M900,M960P,M6 Aster,M4 Nova,M1000	 8-pin connector, keyed		<b>U110-148</b>			
	<b>U110S-148</b>			Pediatric soft tip, 3.0m	D1.3			
	<b>U210S-148</b>			Infant soft tip, 3.0m	D1.3			
	<b>U310-148</b>			Neonate wrap, 3.0m	D1.3			
	<b>U410-148</b>			Adult finger clip, 3.0m	C8.7			
	<b>U410S-148</b>			Adult soft tip, 3.0m	D1.3			
	<b>U610-148</b>			Adult/Neonate wrap, 3.0m	C8.7			
	<b>U610B-148</b>			Pediatric/Infant wrap, 3.0m	C8.7			
	<b>U810-148</b>			Multi-site, 3.0m	C8.7			
	<b>U910-148</b>			Adult ear clip, 3.0m	D1.3			
	 9-pin connector, Keyed			See NE-Tech (OxiSmart) U*03-01 Series Sensor	2.2m		U708-148	 

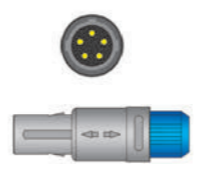

OEM Manufacturer & Models	Sensor Connector	REF# OEM	REF# UNIMED	Sensor Descriptions	Price (unit)	Ext - Cable	Monitor End Conn.	Sensor End Conn.
Philips								
C1, C3, HP Viridia 24C, HeartStart MRx, M3, M3001A, M3001A A01, M3001A A01C06, M3001A A01C12, M3001A A01C18, M4, MP 20, MP 30, MP 40, MP 50, MP 60, MP 70, MP 80, MP 90, Philips Heartstart defibrillator and IntelliVue, SureSigns VS2, SureSigns VS3, VM4, VM6, VM8, Viridia 24C			<b>U103-91</b>	Pediatric finger clip , 1.1m	C8.2	U708-41		
			<b>U103S-91</b>	Pediatric soft tip , 1.1m	C8.2			
			<b>U203S-91</b>	Infant soft tip , 1.1m	C8.2			
			<b>U303-91</b>	Neonate wrap , 1.1m	C8.2			
			<b>U403-91</b>	Adult finger clip , 1.1m	C6			
			<b>U403S-91</b>	Adult soft tip , 1.1m	C8.2			
			<b>U603-91</b>	Adult/Neonate wrap , 1.1m	C6			
			<b>U603B-91</b>	Pediatric/Infant wrap , 1.1m	C6			
			<b>U803-91</b>	Multi-site , 1.1m	C6			
	<b>U903-91</b>	Adult ear clip , 1.1m	C8.2					
M1192A, M1192T, M1195A, M1193A, M1196A, M1191A, M1193T, M1194A			<b>U110-91</b>	Pediatric finger clip, 3.0m	C8	Direct		
			<b>U110S-91</b>	Pediatric soft tip, 3.0m	C8			
			<b>U210S-91</b>	Infant soft tip, 3.0m	C8			
			<b>U310-91</b>	Neonate wrap, 3.0m	C8			
			<b>U410-91</b>	Adult finger clip, 3.0m	C7			
			<b>U410S-91</b>	Adult soft tip, 3.0m	C8			
			<b>U610-91</b>	Adult/Neonate wrap, 3.0m	C7			
			<b>U610B-91</b>	Pediatric/Infant wrap, 3.0m	C7			
			<b>U810-91</b>	Multi-site, 3.0m	C7			
	<b>U910-91</b>	Adult ear clip, 3.0m	C8					
		See NE-Tech (OxiSmart) U*03-01 Series Sensor	3.0m		U710-43 (M1943AL)			
M1020B A02, MP 20 Junior, MP20, MP30, MP40, MP50, MP60, MP70, MP90 A02, M3002A, M8102A, M8105AS, M1020B, M1020B A04, M3001A A04, M3001A, M8105A, M8105AT, M8102A SP4, M8105AS SP4, M8105AT SP4, M8105A SP4			<b>U110-91P</b>	Pediatric finger clip, 3.0m	D2	Direct		
			<b>U110S-91P</b>	Pediatric soft tip, 3.0m	D2			
			<b>U210S-91P</b>	Infant soft tip, 3.0m	D2			
			<b>U310-91P</b>	Neonate wrap, 3.0m	D2			
			<b>U410-91P</b>	Adult finger clip, 3.0m	D1			
			<b>U410S-91P</b>	Adult soft tip, 3.0m	D2			
			<b>U610-91P</b>	Adult/Neonate wrap, 3.0m	D1			
			<b>U610B-91P</b>	Pediatric/Infant wrap, 3.0m	D1			
			<b>U810-91P</b>	Multi-site, 3.0m	D1			
	<b>U910-91P</b>	Adult ear clip, 3.0m	D2					
(*NE-Tech OxiMax)		See NE-Tech (OxiMax) U*03-01P Series Sensor	3.0m		U710X-43 (M1943NL)			
SureSigns VM Monitors (863063, 863064, 863065, 863066, 863068, 863077) SureSigns VS3 Monitors (863071, 863072, 863073, 863074) M1020B Opt. A01 M3000A/M3001A Opt. A01 M3002A Opt. A01 MMS X2 M8102A MP2 M8105A MP5			<b>U110-91MR</b>	Pediatric finger clip, 3.0m	D2	Direct		
			<b>U110S-91MR</b>	Pediatric soft tip, 3.0m	D2			
			<b>U210S-91MR</b>	Infant soft tip, 3.0m	D2			
			<b>U310-91MR</b>	Neonate wrap, 3.0m	D2			
			<b>U410-91MR</b>	Adult finger clip, 3.0m	D1			
			<b>U410S-91MR</b>	Adult soft tip, 3.0m	D2			
			<b>U610-91MR</b>	Adult/Neonate wrap, 3.0m	D1			
			<b>U610B-91MR</b>	Pediatric/Infant wrap, 3.0m	D1			
			<b>U810-91MR</b>	Multi-site, 3.0m	D1			
	<b>U910-91MR</b>	Adult ear clip, 3.0m	D2					
(*M-Tech)		See M-Tech U*03-49R Series Sensor	2.2m		U708M-43R			

Philips Next Page

OEM Manufacturer & Models	Sensor Connector	REF# OEM	REF# UNIMED	Sensor Descriptions	Price (unit)	Ext - Cable	Monitor End Conn.	Sensor End Conn.	
Philips									
MMS: 866462; MP2: 865040; MP5: 865024, 865322; X2: 865039; MMX: 867036; 867191; VS4: 863283; VS30: 863359, 863380; CM10: 863301, 863365; CM12: 863303, 863366; CM100: 863300; CM120: 863302; CM150: 863304, 863322			See M-Tech U*03-49R Series Sensor	3.0m		U710M-270R (989803186531[1.2m] 989803186501[3.0m])			
			See M-Tech U*03-203 Series Sensor	3.0m					U710MR-270 (989803182421[1.2m] 989803186471[3.7m])
		(*M-Tech)	See M-Tech U*03-254 Series Sensor	3.0m					
SureSigns VM Monitors (863063, 863064, 863065, 863066, 863068, 863077) SureSigns VS3 Monitors (863071, 863072, 863073, 863074) M1020B Opt. A01 M3000A/M3001A Opt. A01 M3002A Opt. A01 MMS X2 M8102A MP2 M8105A MP5			<b>U110-20</b>	Pediatric finger clip, 3.0m	C8	Direct			
			<b>U110S-20</b>	Pediatric soft tip, 3.0m	C8				
			<b>U210S-20</b>	Infant soft tip, 3.0m	C8				
			<b>U310-20</b>	Neonate wrap, 3.0m	C8				
			<b>U410-20</b>	Adult finger clip, 3.0m	C7				
			<b>U410S-20</b>	Adult soft tip, 3.0m	C8				
			<b>U610-20</b>	Adult/Neonate wrap, 3.0m	C7				
			<b>U610B-20</b>	Pediatric/Infant wrap, 3.0m	C7				
			<b>U810-20</b>	Multi-site, 3.0m	C7				
	<b>U910-20</b>	Adult ear clip, 3.0m	C8						
(*M-Tech)		See NE-Tech (OxiSmart) U*03-01 Series Sensor	2.2m			U708-20			
		See Philips U*03-91 Series Sensor	2.2m			U708-40			
Philips > Goldway									
UT4000A, UT4000B, UT4000F, UT4000ACS			<b>U110-37</b>	Pediatric finger clip, 3.0m	C8	Direct			
			<b>U110S-37</b>	Pediatric soft tip, 3.0m	C8				
			<b>U210S-37</b>	Infant soft tip, 3.0m	C8				
			<b>U310-37</b>	Neonate wrap, 3.0m	C8				
			<b>U410-37</b>	Adult finger clip, 3.0m	C7				
			<b>U410S-37</b>	Adult soft tip, 3.0m	C8				
			<b>U610-37</b>	Adult/Neonate wrap, 3.0m	C7				
			<b>U610B-37</b>	Pediatric/Infant wrap, 3.0m	C7				
			<b>U810-37</b>	Multi-site, 3.0m	C7				
	<b>U910-37</b>	Adult ear clip, 3.0m	C8						
		See NE-Tech (OxiSmart) U*03-01 Series Sensor	2.2m			U708-37			

Philips > Goldway Next Page

OEM Manufacturer & Models	Sensor Connector	REF# OEM	REF# UNIMED	Sensor Descriptions	Price (unit)	Ext - Cable	Monitor End Conn.	Sensor End Conn.
Philips > Goldway								
UT4000F Pro			<b>U110-38</b>	Pediatric finger clip, 3.0m	C8	Direct		
			<b>U110S-38</b>	Pediatric soft tip, 3.0m	C8			
			<b>U210S-38</b>	Infant soft tip, 3.0m	C8			
			<b>U310-38</b>	Neonate wrap, 3.0m	C8			
			<b>U410-38</b>	Adult finger clip, 3.0m	C7			
			<b>U410S-38</b>	Adult soft tip, 3.0m	C8			
			<b>U610-38</b>	Adult/Neonate wrap, 3.0m	C7			
			<b>U610B-38</b>	Pediatric/Infant wrap, 3.0m	C7			
			<b>U810-38</b>	Multi-site, 3.0m	C7			
			<b>U910-38</b>	Adult ear clip, 3.0m	C8			
		See NE-Tech (OxiSmart) U*03-01 Series Sensor	2.2m		U708-38			
UT4000F Pro (*NE-Tech OxiMax)			<b>U110-38P</b>	Pediatric finger clip, 3.0m	D2	Direct		
			<b>U110S-38P</b>	Pediatric soft tip, 3.0m	D2			
			<b>U210S-38P</b>	Infant soft tip, 3.0m	D2			
			<b>U310-38P</b>	Neonate wrap, 3.0m	D2			
			<b>U410-38P</b>	Adult finger clip, 3.0m	D1			
			<b>U410S-38P</b>	Adult soft tip, 3.0m	D2			
			<b>U610-38P</b>	Adult/Neonate wrap, 3.0m	D1			
			<b>U610B-38P</b>	Pediatric/Infant wrap, 3.0m	D1			
			<b>U810-38P</b>	Multi-site, 3.0m	D1			
			<b>U910-38P</b>	Adult ear clip, 3.0m	D2			
		See NE-Tech (OxiMax) U*03-01P Series Sensor	2.2m		U708X-38			
UT4000C,UT4000E UT4000A Pro, UT4000F Pro UT6000A			<b>U110-11</b>	Pediatric finger clip, 3.0m	D1	Direct		
			<b>U110S-11</b>	Pediatric soft tip, 3.0m	D1			
			<b>U210S-11</b>	Infant soft tip, 3.0m	D1			
			<b>U310-11</b>	Neonate wrap, 3.0m	D1			
			<b>U410-11</b>	Adult finger clip, 3.0m	C8			
			<b>U410S-11</b>	Adult soft tip, 3.0m	D1			
			<b>U610-11</b>	Adult/Neonate wrap, 3.0m	C8			
			<b>U610B-11</b>	Pediatric/Infant wrap, 3.0m	C8			
			<b>U810-11</b>	Multi-site, 3.0m	C8			
			<b>U910-11</b>	Adult ear clip, 3.0m	D1			
		See NE-Tech (OxiSmart) U*03-01 Series Sensor	2.2m		U708-11			

Philips > Goldway Next Page

OEM Manufacturer & Models	Sensor Connector	REF# OEM	REF# UNIMED	Sensor Descriptions	Price (unit)	Ext - Cable	Monitor End Conn.	Sensor End Conn.
Philips > Goldway								
3100 (*Digital Tech)			<b>U110-61D</b>	Pediatric finger clip, 3.0m	C8	Direct		
			<b>U110S-61D</b>	Pediatric soft tip, 3.0m	C8			
			<b>U210S-61D</b>	Infant soft tip, 3.0m	C8			
			<b>U310-61D</b>	Neonate wrap, 3.0m	C8			
			<b>U410-61D</b>	Adult finger clip, 3.0m	C7			
			<b>U410S-61D</b>	Adult soft tip, 3.0m	C8			
			<b>U610-61D</b>	Adult/Neonate wrap, 3.0m	C7			
			<b>U610B-61D</b>	Pediatric/Infant wrap, 3.0m	C7			
			<b>U810-61D</b>	Multi-site, 3.0m	C7			
			<b>U910-61D</b>	Adult ear clip, 3.0m	C8			
		See Digital Tech U*03-42D Series Sensor	2.2m		U708-61			
UT4000B,UT4000F (*Digital Tech)			<b>U110-67D</b>	Pediatric finger clip, 3.0m	C8	Direct		
			<b>U110S-67D</b>	Pediatric soft tip, 3.0m	C8			
			<b>U210S-67D</b>	Infant soft tip, 3.0m	C8			
			<b>U310-67D</b>	Neonate wrap, 3.0m	C8			
			<b>U410-67D</b>	Adult finger clip, 3.0m	C7			
			<b>U410S-67D</b>	Adult soft tip, 3.0m	C8			
			<b>U610-67D</b>	Adult/Neonate wrap, 3.0m	C7			
			<b>U610B-67D</b>	Pediatric/Infant wrap, 3.0m	C7			
			<b>U810-67D</b>	Multi-site, 3.0m	C7			
			<b>U910-67D</b>	Adult ear clip, 3.0m	C8			
UT6000A, G30, G60 (*Philips Tech)			<b>U110-91</b>	Pediatric finger clip, 3.0m	C8	Direct		
			<b>U110S-91</b>	Pediatric soft tip, 3.0m	C8			
			<b>U210S-91</b>	Infant soft tip, 3.0m	C8			
			<b>U310-91</b>	Neonate wrap, 3.0m	C8			
			<b>U410-91</b>	Adult finger clip, 3.0m	C7			
			<b>U410S-91</b>	Adult soft tip, 3.0m	C8			
			<b>U610-91</b>	Adult/Neonate wrap, 3.0m	C7			
			<b>U610B-91</b>	Pediatric/Infant wrap, 3.0m	C7			
			<b>U810-91</b>	Multi-site, 3.0m	C7			
			<b>U910-91</b>	Adult ear clip, 3.0m	C8			













OEM Manufacturer & Models	Sensor Connector	REF# OEM	REF# UNIMED	Sensor Descriptions	Price (unit)	Ext - Cable	Monitor End Conn.	Sensor End Conn.
RGB Medical								
Omicrom FT, Omicron PREMIUM (*BCI Tech)	 7-pin lemo connector, 1 notch		<b>U110-76</b>	Pediatric finger clip, 3.0m	C8	Direct		
			<b>U110S-76</b>	Pediatric soft tip, 3.0m	C8			
			<b>U210S-76</b>	Infant soft tip, 3.0m	C8			
			<b>U310-76</b>	Neonate wrap, 3.0m	C8			
			<b>U410-76</b>	Adult finger clip, 3.0m	C7			
			<b>U410S-76</b>	Adult soft tip, 3.0m	C8			
			<b>U610-76</b>	Adult/Neonate wrap, 3.0m	C7			
			<b>U610B-76</b>	Pediatric/Infant wrap, 3.0m	C7			
			<b>U810-76</b>	Multi-site, 3.0m	C7			
			<b>U910-76</b>	Adult ear clip, 3.0m	C8			
	 9-pin connector, Keyed	See BCI U*03-06 Series Sensor	2.2m		U708-76			
Risingmed								
RPM-9000A	 6-pin lemo connector, 2 notches, 40° keyed		<b>U110-217</b>	Pediatric finger clip, 3.0m	C8	Direct		
			<b>U110S-217</b>	Pediatric soft tip, 3.0m	C8			
			<b>U210S-217</b>	Infant soft tip, 3.0m	C8			
			<b>U310-217</b>	Neonate wrap, 3.0m	C8			
			<b>U410-217</b>	Adult finger clip, 3.0m	C7			
			<b>U410S-217</b>	Adult soft tip, 3.0m	C8			
			<b>U610-217</b>	Adult/Neonate wrap, 3.0m	C7			
			<b>U610B-217</b>	Pediatric/Infant wrap, 3.0m	C7			
			<b>U810-217</b>	Multi-site, 3.0m	C7			
			<b>U910-217</b>	Adult ear clip, 3.0m	C8			
	 9-pin connector, Keyed	See NE-Tech (OxiSmart) U*03-01 Series Sensor	2.2m		U708-217			
Schiller								
Argus CM8, SM783, SM784, SM785, TM910	 7-pin connector, keyed		<b>U110-17</b>	Pediatric finger clip, 3.0m	C8	Direct		
			<b>U110S-17</b>	Pediatric soft tip, 3.0m	C8			
			<b>U210S-17</b>	Infant soft tip, 3.0m	C8			
			<b>U310-17</b>	Neonate wrap, 3.0m	C8			
			<b>U410-17</b>	Adult finger clip, 3.0m	C7			
			<b>U410S-17</b>	Adult soft tip, 3.0m	C8			
			<b>U610-17</b>	Adult/Neonate wrap, 3.0m	C7			
			<b>U610B-17</b>	Pediatric/Infant wrap, 3.0m	C7			
			<b>U810-17</b>	Multi-site, 3.0m	C7			
			<b>U910-17</b>	Adult ear clip, 3.0m	C8			
	 9-pin connector, Keyed	See NE-Tech (OxiSmart) U*03-01 Series Sensor	2.2m		U708-17			

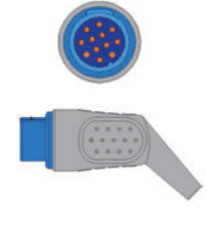



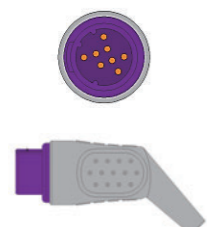

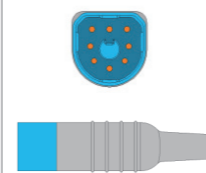

Schiller Next Page

OEM Manufacturer & Models	Sensor Connector	REF# OEM	REF# UNIMED	Sensor Descriptions	Price (unit)	Ext - Cable	Monitor End Conn.	Sensor End Conn.
Schiller								
Argus LCM, Argus Pro, TM7 (*M-Tech)	 7-pin connector, keyed		<b>U110-17M</b>	Pediatric finger clip, 3.0m	C8	Direct		
			<b>U110S-17M</b>	Pediatric soft tip, 3.0m	C8			
			<b>U210S-17M</b>	Infant soft tip, 3.0m	C8			
			<b>U310-17M</b>	Neonate wrap, 3.0m	C8			
			<b>U410-17M</b>	Adult finger clip, 3.0m	C7			
			<b>U410S-17M</b>	Adult soft tip, 3.0m	C8			
			<b>U610-17M</b>	Adult/Neonate wrap, 3.0m	C7			
			<b>U610B-17M</b>	Pediatric/Infant wrap, 3.0m	C7			
			<b>U810-17M</b>	Multi-site, 3.0m	C7			
			<b>U910-17M</b>	Adult ear clip, 3.0m	C8			
	 9-pin connector, Keyed	See M-Tech U*03-49R Series Sensor	2.2m		U708M-17			
Propaq CS, Encore, Micropaq (New) (M) ARGUS OXM PLUS ARGUS® VS-100 (*M-Tech)	 14-pin connector		<b>U110-15R</b>	Pediatric finger clip, 3.0m	D1	Direct		
			<b>U110S-15R</b>	Pediatric soft tip, 3.0m	D1			
			<b>U210S-15R</b>	Infant soft tip, 3.0m	D1			
			<b>U310-15R</b>	Neonate wrap, 3.0m	D1			
			<b>U410-15R</b>	Adult finger clip, 3.0m	C8			
			<b>U410S-15R</b>	Adult soft tip, 3.0m	D1			
			<b>U610-15R</b>	Adult/Neonate wrap, 3.0m	C8			
			<b>U610B-15R</b>	Pediatric/Infant wrap, 3.0m	C8			
			<b>U810-15R</b>	Multi-site, 3.0m	C8			
			<b>U910-15R</b>	Adult ear clip, 3.0m	D1			
	 9-pin connector, Keyed	See M-Tech U*03-49R Series Sensor	2.2m		U708M-15R			
TM 910-Defigard, 500, ARGUS® LCX ARGUS® LCM plus	 12-pin connector, keyed		<b>U110-63</b>	Pediatric finger clip, 3.0m	C8	Direct		
			<b>U110S-63</b>	Pediatric soft tip, 3.0m	C8			
			<b>U210S-63</b>	Infant soft tip, 3.0m	C8			
			<b>U310-63</b>	Neonate wrap, 3.0m	C8			
			<b>U410-63</b>	Adult finger clip, 3.0m	C7			
			<b>U410S-63</b>	Adult soft tip, 3.0m	C8			
			<b>U610-63</b>	Adult/Neonate wrap, 3.0m	C7			
			<b>U610B-63</b>	Pediatric/Infant wrap, 3.0m	C7			
			<b>U810-63</b>	Multi-site, 3.0m	C7			
			<b>U910-63</b>	Adult ear clip, 3.0m	C8			
	 9-pin connector, Keyed	See NE-Tech (OxiSmart) U*03-01 Series Sensor	2.2m		U708-63			

Schiller Next Page

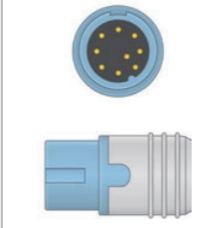





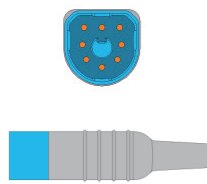



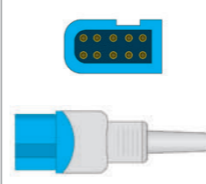

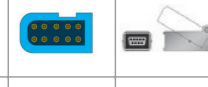

OEM Manufacturer & Models	Sensor Connector	REF# OEM	REF# UNIMED	Sensor Descriptions	Price (unit)	Ext - Cable	Monitor End Conn.	Sensor End Conn.
<b>Schiller</b>								
Defigard4000, Defigard5000 ARGUS® PRO LifeCare  (*M-Tech)			<b>U110-63M</b>	Pediatric finger clip, 3.0m	D1	Direct		
			<b>U110S-63M</b>	Pediatric soft tip, 3.0m	D1			
			<b>U210S-63M</b>	Infant soft tip, 3.0m	D1			
			<b>U310-63M</b>	Neonate wrap, 3.0m	D1			
			<b>U410-63M</b>	Adult finger clip, 3.0m	C8			
			<b>U410S-63M</b>	Adult soft tip, 3.0m	D1			
			<b>U610-63M</b>	Adult/Neonate wrap, 3.0m	C8			
			<b>U610B-63M</b>	Pediatric/Infant wrap, 3.0m	C8			
			<b>U810-63M</b>	Multi-site, 3.0m	C8			
			<b>U910-63M</b>	Adult ear clip, 3.0m	D1			
		See M-Tech U*03-49R Series Sensor	2.2m		U708M-63			
ARGUS® PRO LifeCare 2 DEFIGARD® Touch 7  (*M-Tech Rainbow)			<b>U110-63MR</b>	Pediatric finger clip, 3.0m	D2	Direct		
			<b>U110S-63MR</b>	Pediatric soft tip, 3.0m	D2			
			<b>U210S-63MR</b>	Infant soft tip, 3.0m	D2			
			<b>U310-63MR</b>	Neonate wrap, 3.0m	D2			
			<b>U410-63MR</b>	Adult finger clip, 3.0m	D1			
			<b>U410S-63MR</b>	Adult soft tip, 3.0m	D2			
			<b>U610-63MR</b>	Adult/Neonate wrap, 3.0m	D1			
			<b>U610B-63MR</b>	Pediatric/Infant wrap, 3.0m	D1			
			<b>U810-63MR</b>	Multi-site, 3.0m	D1			
			<b>U910-63MR</b>	Adult ear clip, 3.0m	D2			
		See M-Tech U*03-49R Series Sensor	2.2m		U708M-63R			
ARGUS® LCM Plus  (NE-Tech OxiMax)			<b>U110-63P</b>	Pediatric finger clip, 3.0m	D2	Direct		
			<b>U110S-63P</b>	Pediatric soft tip, 3.0m	D2			
			<b>U210S-63P</b>	Infant soft tip, 3.0m	D2			
			<b>U310-63P</b>	Neonate wrap, 3.0m	D2			
			<b>U410-63P</b>	Adult finger clip, 3.0m	D1			
			<b>U410S-63P</b>	Adult soft tip, 3.0m	D2			
			<b>U610-63P</b>	Adult/Neonate wrap, 3.0m	D1			
			<b>U610B-63P</b>	Pediatric/Infant wrap, 3.0m	D1			
			<b>U810-63P</b>	Multi-site, 3.0m	D1			
			<b>U910-63P</b>	Adult ear clip, 3.0m	D2			
		See NE-Tech (OxiMax) U*03-01P Series Sensor	2.2m		U708X-63			

OEM Manufacturer & Models	Sensor Connector	REF# OEM	REF# UNIMED	Sensor Descriptions	Price (unit)	Ext - Cable	Monitor End Conn.	Sensor End Conn.
<b>Senmind</b>								
KP9000 KP-930/930F			<b>U110-168D</b>	Pediatric finger clip, 3.0m	D1	Direct		
			<b>U110S-168D</b>	Pediatric soft tip, 3.0m	D1			
			<b>U210S-168D</b>	Infant soft tip, 3.0m	D1			
			<b>U310-168D</b>	Neonate wrap, 3.0m	D1			
			<b>U410-168D</b>	Adult finger clip, 3.0m	C8			
			<b>U410S-168D</b>	Adult soft tip, 3.0m	D1			
			<b>U610-168D</b>	Adult/Neonate wrap, 3.0m	C8			
			<b>U610B-168D</b>	Pediatric/Infant wrap, 3.0m	C8			
			<b>U810-168D</b>	Multi-site, 3.0m	C8			
			<b>U910-168D</b>	Adult ear clip, 3.0m	D1			
<b>Simed</b>								
S-100, S-100e, S-50			<b>U110-12</b>	Pediatric finger clip, 3.0m	C8	Direct		
			<b>U110S-12</b>	Pediatric soft tip, 3.0m	C8			
			<b>U210S-12</b>	Infant soft tip, 3.0m	C8			
			<b>U310-12</b>	Neonate wrap, 3.0m	C8			
			<b>U410-12</b>	Adult finger clip, 3.0m	C7			
			<b>U410S-12</b>	Adult soft tip, 3.0m	C8			
			<b>U610-12</b>	Adult/Neonate wrap, 3.0m	C7			
			<b>U610B-12</b>	Pediatric/Infant wrap, 3.0m	C7			
			<b>U810-12</b>	Multi-site, 3.0m	C7			
			<b>U910-12</b>	Adult ear clip, 3.0m	C8			
		See NE-Tech (OxiSmart) U*03-01 Series Sensor	2.2m		U708-12			
<b>Sinohero</b>								
AcuitSign M6  (*Digital Tech)			<b>U110-205D</b>	Pediatric finger clip, 3.0m	<b>D1</b>	Direct		
			<b>U110S-205D</b>	Pediatric soft tip, 3.0m	<b>D1</b>			
			<b>U210S-205D</b>	Infant soft tip, 3.0m	<b>D1</b>			
			<b>U310-205D</b>	Neonate wrap, 3.0m	<b>D1</b>			
			<b>U410-205D</b>	Adult finger clip, 3.0m	<b>C8</b>			
			<b>U410S-205D</b>	Adult soft tip, 3.0m	<b>D1</b>			
			<b>U610-205D</b>	Adult/Neonate wrap, 3.0m	<b>C8</b>			
			<b>U610B-205D</b>	Pediatric/Infant wrap, 3.0m	<b>C8</b>			
			<b>U810-205D</b>	Multi-site, 3.0m	<b>C8</b>			
			<b>U910-205D</b>	Adult ear clip, 3.0m	<b>D1</b>			
		See Biolight Digital U*03-62D Series Sensor	2.2m		U708-261			

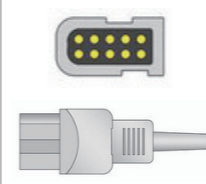
OEM Manufacturer & Models	Sensor Connector	REF# OEM	REF# UNIMED	Sensor Descriptions	Price (unit)	Ext - Cable	Monitor End Conn.	Sensor End Conn.
Solaris								
NT2A, NT2C  (*Philips Tech)	 8-pin D connector, keyed		<b>U110-91</b>	Pediatric finger clip, 3.0m	C8	Direct		
			<b>U110S-91</b>	Pediatric soft tip, 3.0m	C8			
			<b>U210S-91</b>	Infant soft tip, 3.0m	C8			
			<b>U310-91</b>	Neonate wrap, 3.0m	C8			
			<b>U410-91</b>	Adult finger clip, 3.0m	C7			
			<b>U410S-91</b>	Adult soft tip, 3.0m	C8			
			<b>U610-91</b>	Adult/Neonate wrap, 3.0m	C7			
			<b>U610B-91</b>	Pediatric/Infant wrap, 3.0m	C7			
			<b>U810-91</b>	Multi-site, 3.0m	C7			
			<b>U910-91</b>	Adult ear clip, 3.0m	C8			
Spacelabs								
Ultraview 90369, 90419-01, 9046, 90466, 90467, 90489, 90603A, 90651-07/08, 90651A, 90651A-07  (*Novamatrix Tech)	 7-pin connector, keyed		<b>U110-03</b>	Pediatric finger clip, 3.0m	C8	Direct		
			<b>U110S-03</b>	Pediatric soft tip, 3.0m	C8			
			<b>U210S-03</b>	Infant soft tip, 3.0m	C8			
			<b>U310-03</b>	Neonate wrap, 3.0m	C8			
			<b>U410-03</b>	Adult finger clip, 3.0m	C7			
			<b>U410S-03</b>	Adult soft tip, 3.0m	C8			
			<b>U610-03</b>	Adult/Neonate wrap, 3.0m	C7			
			<b>U610B-03</b>	Pediatric/Infant wrap, 3.0m	C7			
			<b>U810-03</b>	Multi-site, 3.0m	C7			
			<b>U910-03</b>	Adult ear clip, 3.0m	C8			
	 9-pin connector, Keyed	See Novamatrix U*03-03Series Sensor	2.2m		U708-03			
466, 90308, 90309, 90351-0/6, 90465, 90489, 90651A, PC Scout	 7-pin connector, keyed		<b>U110-04</b>	Pediatric finger clip, 3.0m	D1	Direct		
			<b>U110S-04</b>	Pediatric soft tip, 3.0m	D1			
			<b>U210S-04</b>	Infant soft tip, 3.0m	D1			
			<b>U310-04</b>	Neonate wrap, 3.0m	D1			
			<b>U410-04</b>	Adult finger clip, 3.0m	C8			
			<b>U410S-04</b>	Adult soft tip, 3.0m	D1			
			<b>U610-04</b>	Adult/Neonate wrap, 3.0m	C8			
			<b>U610B-04</b>	Pediatric/Infant wrap, 3.0m	C8			
			<b>U810-04</b>	Multi-site, 3.0m	C8			
			<b>U910-04</b>	Adult ear clip, 3.0m	D1			
	 9-pin connector, Keyed	See NE-Tech (OxiSmart) U*03-01 Series Sensor	2.2m		U708-04			

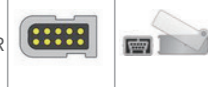
Spacelabs Next Page











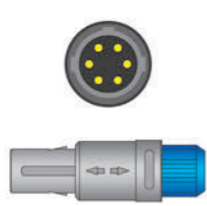

OEM Manufacturer & Models	Sensor Connector	REF# OEM	REF# UNIMED	Sensor Descriptions	Price (unit)	Ext - Cable	Monitor End Conn.	Sensor End Conn.
Spacelabs								
466, 90308, 90309, 90351-0/6, 90465, 90489, 90651A, PC Scout	 10-pin connector, keyed		<b>U110-74</b>	Pediatric finger clip, 3.0m	D2	Direct		
			<b>U110S-74</b>	Pediatric soft tip, 3.0m	D2			
			<b>U210S-74</b>	Infant soft tip, 3.0m	D2			
			<b>U310-74</b>	Neonate wrap, 3.0m	D2			
			<b>U410-74</b>	Adult finger clip, 3.0m	D1			
			<b>U410S-74</b>	Adult soft tip, 3.0m	D2			
			<b>U610-74</b>	Adult/Neonate wrap, 3.0m	D1			
			<b>U610B-74</b>	Pediatric/Infant wrap, 3.0m	D1			
			<b>U810-74</b>	Multi-site, 3.0m	D1			
			<b>U910-74</b>	Adult ear clip, 3.0m	D2			
	 9-pin connector, Keyed	See NE-Tech (OxiSmart) U*03-01 Series Sensor	3.0m		U710-74 (700-0030-00)			
1050, 1600, 1700, 90369, 904, 90469, 91220-B, 96, Ultraview, Ultraview SL, 91367, 91369  (NE-Tech OxiMax)	 10-pin connector, keyed		<b>U110-74P</b>	Pediatric finger clip, 3.0m	D2	Direct		
			<b>U110S-74P</b>	Pediatric soft tip, 3.0m	D2			
			<b>U210S-74P</b>	Infant soft tip, 3.0m	D2			
			<b>U310-74P</b>	Neonate wrap, 3.0m	D2			
			<b>U410-74P</b>	Adult finger clip, 3.0m	D1			
			<b>U410S-74P</b>	Adult soft tip, 3.0m	D2			
			<b>U610-74P</b>	Adult/Neonate wrap, 3.0m	D1			
			<b>U610B-74P</b>	Pediatric/Infant wrap, 3.0m	D1			
			<b>U810-74P</b>	Multi-site, 3.0m	D1			
			<b>U910-74P</b>	Adult ear clip, 3.0m	D2			
	 9-pin connector, Keyed	See NE-Tech (OxiMax) U*03-01P Series Sensor	2.2m		U708X-74			
91367, 91369, 91496  (*M-Tech Rainbow)	 10-pin connector, keyed		<b>U110-74MR</b>	Pediatric finger clip, 3.0m	D3	Direct		
			<b>U110S-74MR</b>	Pediatric soft tip, 3.0m	D3			
			<b>U210S-74MR</b>	Infant soft tip, 3.0m	D3			
			<b>U310-74MR</b>	Neonate wrap, 3.0m	D3			
			<b>U410-74MR</b>	Adult finger clip, 3.0m	D2			
			<b>U410S-74MR</b>	Adult soft tip, 3.0m	D3			
			<b>U610-74MR</b>	Adult/Neonate wrap, 3.0m	D2			
			<b>U610B-74MR</b>	Pediatric/Infant wrap, 3.0m	D2			
			<b>U810-74MR</b>	Multi-site, 3.0m	D2			
			<b>U910-74MR</b>	Adult ear clip, 3.0m	D3			
	 9-pin connector, Keyed	See M-Tech U*03-49R Series Sensor	2.2m		U708M-74R			

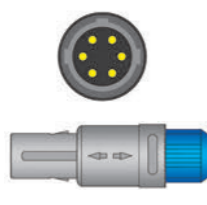

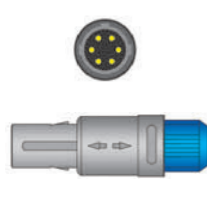

Spacelabs Next Page





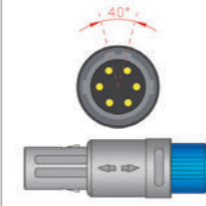



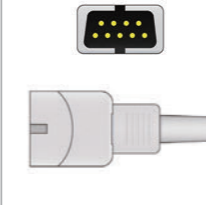
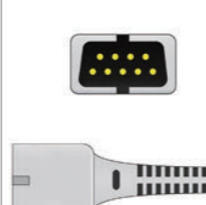

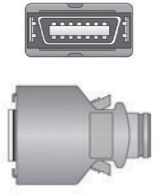

OEM Manufacturer & Models	Sensor Connector	REF# OEM	REF# UNIMED	Sensor Descriptions	Price (unit)	Ext - Cable	Monitor End Conn.	Sensor End Conn.						
Spacelabs														
PRO2 (*BCI Tech)	 9-pin connector	3178	U103-06	Pediatric finger clip , 1.1m	C5	Direct								
			U103S-06	Pediatric soft tip , 1.1m	C5									
			U203S-06	Infant soft tip , 1.1m	C5									
		3044/3444	U303-06	Neonate wrap , 1.1m	C5									
			U403-06	Adult finger clip , 1.1m	C3.8									
			U403S-06	Adult soft tip , 1.1m	C5									
			U603-06	Adult/Neonate wrap , 1.1m	C3.8									
		V1703/3043	U603B-06	Pediatric/Infant wrap , 1.1m	C3.8									
			U803-06	Multi-site , 1.1m	C3.8									
		3078	U903-06	Adult ear clip , 1.1m	C5									
Takaoka														
9504, 9504 ECG, Oxifast, Oxipani	 6-pin lemo connector, 1 notch		U110-99	Pediatric finger clip, 3.0m	C8	Direct								
			U110S-99	Pediatric soft tip, 3.0m	C8									
			U210S-99	Infant soft tip, 3.0m	C8									
			U310-99	Neonate wrap, 3.0m	C8									
			U410-99	Adult finger clip, 3.0m	C7									
			U410S-99	Adult soft tip, 3.0m	C8									
			U610-99	Adult/Neonate wrap, 3.0m	C7									
			U610B-99	Pediatric/Infant wrap, 3.0m	C7									
			U810-99	Multi-site, 3.0m	C7									
			U910-99	Adult ear clip, 3.0m	C8									
TianRong														
TR-900B	 6-pin lemo connector, 2 notches, 40° keyed		U110-190	Pediatric finger clip, 3.0m	C7	Direct								
			U110S-190	Pediatric soft tip, 3.0m	C7									
			U210S-190	Infant soft tip, 3.0m	C7									
			U310-190	Neonate wrap, 3.0m	C7									
			U410-190	Adult finger clip, 3.0m	C5									
			U410S-190	Adult soft tip, 3.0m	C7									
			U610-190	Adult/Neonate wrap, 3.0m	C5									
			U610B-190	Pediatric/Infant wrap, 3.0m	C5									
			U810-190	Multi-site, 3.0m	C5									
			U910-190	Adult ear clip, 3.0m	C7									
Triton														
MRP6-03 T1.19,P1.19 MRP6-03 T2.19,P6.19 MRP6-03 T3.19,P8.19 MRP6-03 T4.19	 9-pin lemo connector, 1 notch		U110-135	Pediatric finger clip, 3.0m	C8	Direct								
			U110S-135	Pediatric soft tip, 3.0m	C8									
			U210S-135	Infant soft tip, 3.0m	C8									
			U310-135	Neonate wrap, 3.0m	C8									
			U410-135	Adult finger clip, 3.0m	C7									
			U410S-135	Adult soft tip, 3.0m	C8									
			U610-135	Adult/Neonate wrap, 3.0m	C7									
			U610B-135	Pediatric/Infant wrap, 3.0m	C7									
			U810-135	Multi-site, 3.0m	C7									
			U910-135	Adult ear clip, 3.0m	C8									
			See NE-Tech (OxiSmart) U*03-01 Series Sensor	2.2m					U708-135					
			Triton Next Page											

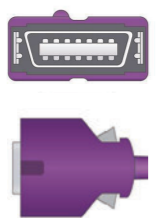



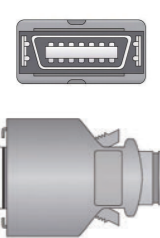



OEM Manufacturer & Models	Sensor Connector	REF# OEM	REF# UNIMED	Sensor Descriptions	Price (unit)	Ext - Cable	Monitor End Conn.	Sensor End Conn.
Triton								
MRP6-03 P1.19	 7-pin lemo connector, 2 notches, 40° Keyed		U110-236	Pediatric finger clip, 3.0m	C8	Direct		
			U110S-236	Pediatric soft tip, 3.0m	C8			
			U210S-236	Infant soft tip, 3.0m	C8			
			U310-236	Neonate wrap, 3.0m	C8			
			U410-236	Adult finger clip, 3.0m	C7			
			U410S-236	Adult soft tip, 3.0m	C8			
			U610-236	Adult/Neonate wrap, 3.0m	C7			
			U610B-236	Pediatric/Infant wrap, 3.0m	C7			
			U810-236	Multi-site, 3.0m	C7			
			U910-236	Adult ear clip, 3.0m	C8			
	 9-pin connector, Keyed	See NE-Tech (OxiSmart) U*03-01 Series Sensor	2.2m			U708-236		
			MRP6-03 P2.19 MRP6-03 P3.19 MRP6-03 P4.19 MRP6-03 P5.19 MRP6-03 P6.19					
MRP6-03 P2.19 MRP6-03 P3.19 MRP6-03 P4.19 MRP6-03 P5.19 MRP6-03 P6.19 (*M-Tech)	 14-pin connector	01-02-0730, 01-02-0712	U110-15R	Pediatric finger clip, 3.0m	D1	Direct		
			U110S-15R	Pediatric soft tip, 3.0m	D1			
			U210S-15R	Infant soft tip, 3.0m	D1			
			U310-15R	Neonate wrap, 3.0m	D1			
			U410-15R	Adult finger clip, 3.0m	C8			
			U410S-15R	Adult soft tip, 3.0m	D1			
			U610-15R	Adult/Neonate wrap, 3.0m	C8			
			U610B-15R	Pediatric/Infant wrap, 3.0m	C8			
			U810-15R	Multi-site, 3.0m	C8			
			U910-15R	Adult ear clip, 3.0m	D1			
	 9-pin connector, Keyed	See M-Tech U*03-49R Series Sensor	2.2m			U708M-15R		
			Unicare					
F6,F8,F9,F15 (*Digital Tech)	 6-pin lemo connector, 1 notch		U110-66D	Pediatric finger clip, 3.0m	D1	Direct		
			U110S-66D	Pediatric soft tip, 3.0m	D1			
			U210S-66D	Infant soft tip, 3.0m	D1			
			U310-66D	Neonate wrap, 3.0m	D1			
			U410-66D	Adult finger clip, 3.0m	C8			
			U410S-66D	Adult soft tip, 3.0m	D1			
			U610-66D	Adult/Neonate wrap, 3.0m	C8			
			U610B-66D	Pediatric/Infant wrap, 3.0m	C8			
			U810-66D	Multi-site, 3.0m	C8			
			U910-66D	Adult ear clip, 3.0m	D1			
	 9-pin connector, Keyed	See Digital Tech U*03-42D Series Sensor	2.2m			U708-45		
			Unicare Next Page					

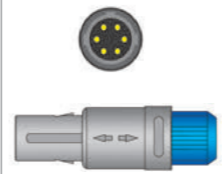

OEM Manufacturer & Models	Sensor Connector	REF# OEM	REF# UNIMED	Sensor Descriptions	Price (unit)	Ext - Cable	Monitor End Conn.	Sensor End Conn.
<b>Unicare</b>								
F8/S	 <p>6-pin lemo connector, 1 notch</p>		<b>U110-120</b>	Pediatric finger clip, 3.0m	C8	Direct		
			<b>U110S-120</b>	Pediatric soft tip, 3.0m	C8			
			<b>U210S-120</b>	Infant soft tip, 3.0m	C8			
			<b>U310-120</b>	Neonate wrap, 3.0m	C8			
			<b>U410-120</b>	Adult finger clip, 3.0m	C7			
			<b>U410S-120</b>	Adult soft tip, 3.0m	C8			
			<b>U610-120</b>	Adult/Neonate wrap, 3.0m	C7			
			<b>U610B-120</b>	Pediatric/Infant wrap, 3.0m	C7			
			<b>U810-120</b>	Multi-site, 3.0m	C7			
			<b>U910-120</b>	Adult ear clip, 3.0m	C8			
	 <p>9-pin connector, Keyed</p>	See NE-Tech (OxiSmart) U*03-01 Series Sensor	2.2m		U708-120	 		
<b>Uray</b>								
UR-8000 UR-9000	 <p>6-pin lemo connector, 1 notch</p>		<b>U110-143</b>	Pediatric finger clip, 3.0m	C8	Direct		
			<b>U110S-143</b>	Pediatric soft tip, 3.0m	C8			
			<b>U210S-143</b>	Infant soft tip, 3.0m	C8			
			<b>U310-143</b>	Neonate wrap, 3.0m	C8			
			<b>U410-143</b>	Adult finger clip, 3.0m	C7			
			<b>U410S-143</b>	Adult soft tip, 3.0m	C8			
			<b>U610-143</b>	Adult/Neonate wrap, 3.0m	C7			
			<b>U610B-143</b>	Pediatric/Infant wrap, 3.0m	C7			
			<b>U810-143</b>	Multi-site, 3.0m	C7			
			<b>U910-143</b>	Adult ear clip, 3.0m	C8			
	 <p>9-pin connector, Keyed</p>	See NE-Tech (OxiSmart) U*03-01 Series Sensor	2.2m		U708-143	 		
<b>Utech</b>								
VS2000 (*Digital Tech)	 <p>6-pin lemo connector, 1 notch</p>		<b>U110-66D</b>	Pediatric finger clip, 3.0m	D1	Direct		
			<b>U110S-66D</b>	Pediatric soft tip, 3.0m	D1			
			<b>U210S-66D</b>	Infant soft tip, 3.0m	D1			
			<b>U310-66D</b>	Neonate wrap, 3.0m	D1			
			<b>U410-66D</b>	Adult finger clip, 3.0m	C8			
			<b>U410S-66D</b>	Adult soft tip, 3.0m	D1			
			<b>U610-66D</b>	Adult/Neonate wrap, 3.0m	C8			
			<b>U610B-66D</b>	Pediatric/Infant wrap, 3.0m	C8			
			<b>U810-66D</b>	Multi-site, 3.0m	C8			
			<b>U910-66D</b>	Adult ear clip, 3.0m	D1			
	 <p>9-pin connector, Keyed</p>	See Digital Tech U*03-42D Series Sensor	2.2m		U708-45	 		

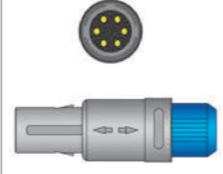
OEM Manufacturer & Models	Sensor Connector	REF# OEM	REF# UNIMED	Sensor Descriptions	Price (unit)	Ext - Cable	Monitor End Conn.	Sensor End Conn.
<b>UTAS</b>								
UM-300	 <p>6-pin lemo connector, 2 notches, 40° keyed</p>		<b>U110-129</b>	Pediatric finger clip, 3.0m	C8	Direct		
			<b>U110S-129</b>	Pediatric soft tip, 3.0m	C8			
			<b>U210S-129</b>	Infant soft tip, 3.0m	C8			
			<b>U310-129</b>	Neonate wrap, 3.0m	C8			
			<b>U410-129</b>	Adult finger clip, 3.0m	C7			
			<b>U410S-129</b>	Adult soft tip, 3.0m	C8			
			<b>U610-129</b>	Adult/Neonate wrap, 3.0m	C7			
			<b>U610B-129</b>	Pediatric/Infant wrap, 3.0m	C7			
			<b>U810-129</b>	Multi-site, 3.0m	C7			
			<b>U910-129</b>	Adult ear clip, 3.0m	C8			
	 <p>9-pin connector, Keyed</p>	See NE-Tech (OxiSmart) U*03-01 Series Sensor	2.2m		U708-129	 		
<b>Votem</b>								
VP-1200, VP-700 (*MEK Tech)	 <p>9-pin connector, keyed</p>		<b>U110-26</b>	Pediatric finger clip, 3.0m	C7	Direct		
			<b>U110S-26</b>	Pediatric soft tip, 3.0m	C7			
			<b>U210S-26</b>	Infant soft tip, 3.0m	C7			
			<b>U310-26</b>	Neonate wrap, 3.0m	C7			
			<b>U410-26</b>	Adult finger clip, 3.0m	C5			
			<b>U410S-26</b>	Adult soft tip, 3.0m	C7			
			<b>U610-26</b>	Adult/Neonate wrap, 3.0m	C5			
			<b>U610B-26</b>	Pediatric/Infant wrap, 3.0m	C5			
			<b>U810-26</b>	Multi-site, 3.0m	C5			
			<b>U910-26</b>	Adult ear clip, 3.0m	C7			
VP-1000 (*NE Tech OxiSmart)	 <p>9-pin connector, keyed</p>		<b>U110-01</b>	Pediatric finger clip, 3.0m	C7	Direct		
			<b>U110S-01</b>	Pediatric soft tip, 3.0m	C7			
			<b>U210S-01</b>	Infant soft tip, 3.0m	C7			
			<b>U310-01</b>	Neonate wrap, 3.0m	C7			
			<b>U410-01</b>	Adult finger clip, 3.0m	C5			
			<b>U410S-01</b>	Adult soft tip, 3.0m	C7			
			<b>U610-01</b>	Adult/Neonate wrap, 3.0m	C5			
			<b>U610B-01</b>	Pediatric/Infant wrap, 3.0m	C5			
			<b>U810-01</b>	Multi-site, 3.0m	C5			
			<b>U910-01</b>	Adult ear clip, 3.0m	C7			

OEM Manufacturer & Models	Sensor Connector	REF# OEM	REF# UNIMED	Sensor Descriptions	Price (unit)	Ext - Cable	Monitor End Conn.	Sensor End Conn.
<b>Welch Allyn</b>								
45NE0-E1 LX, 53STP, Propaq CS, Spot Vital Signs 42MTB-E1, Spot Vital Signs Ixi  (*M-Tech)	 14-pin connector		<b>U110-15R</b>	Pediatric finger clip, 3.0m	D1	Direct		
			<b>U110S-15R</b>	Pediatric soft tip, 3.0m	D1			
			<b>U210S-15R</b>	Infant soft tip, 3.0m	D1			
			<b>U310-15R</b>	Neonate wrap, 3.0m	D1			
			<b>U410-15R</b>	Adult finger clip, 3.0m	C8			
			<b>U410S-15R</b>	Adult soft tip, 3.0m	D1			
			<b>U610-15R</b>	Adult/Neonate wrap, 3.0m	C8			
			<b>U610B-15R</b>	Pediatric/Infant wrap, 3.0m	C8			
			<b>U810-15R</b>	Multi-site, 3.0m	C8			
			<b>U910-15R</b>	Adult ear clip, 3.0m	D1			
	 9-pin connector	See M-Tech U*03-49R Series Sensor	2.2m		U708M-15R			
42NT0-E1 LXi, 45NE0-E1 LX, 53STP, Propaq CS, Spot Vital Signs 42NTB-E1  (*NE-Tech OxiMax)	 14-pin connector		<b>U110-70P</b>	Pediatric finger clip, 3.0m	D2	Direct		
			<b>U110S-70P</b>	Pediatric soft tip, 3.0m	D2			
			<b>U210S-70P</b>	Infant soft tip, 3.0m	D2			
			<b>U310-70P</b>	Neonate wrap, 3.0m	D2			
			<b>U410-70P</b>	Adult finger clip, 3.0m	D1			
			<b>U410S-70P</b>	Adult soft tip, 3.0m	D2			
			<b>U610-70P</b>	Adult/Neonate wrap, 3.0m	D1			
			<b>U610B-70P</b>	Pediatric/Infant wrap, 3.0m	D1			
			<b>U810-70P</b>	Multi-site, 3.0m	D1			
			<b>U910-70P</b>	Adult ear clip, 3.0m	D2			
	 9-pin connector	See NE-Tech (OxiMax) U*03-01P Series Sensor	2.2m		U708-70			
<b>Zoll</b>								
M Series  (*M-Tech)	 14-pin connector		<b>U110-15R</b>	Pediatric finger clip, 3.0m	D1	Direct		
			<b>U110S-15R</b>	Pediatric soft tip, 3.0m	D1			
			<b>U210S-15R</b>	Infant soft tip, 3.0m	D1			
			<b>U310-15R</b>	Neonate wrap, 3.0m	D1			
			<b>U410-15R</b>	Adult finger clip, 3.0m	C8			
			<b>U410S-15R</b>	Adult soft tip, 3.0m	D1			
			<b>U610-15R</b>	Adult/Neonate wrap, 3.0m	C8			
			<b>U610B-15R</b>	Pediatric/Infant wrap, 3.0m	C8			
			<b>U810-15R</b>	Multi-site, 3.0m	C8			
			<b>U910-15R</b>	Adult ear clip, 3.0m	D1			
	 9-pin connector, Keyed	See M-Tech U*03-49R Series Sensor	2.2m		U708M-15R			

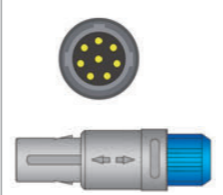
OEM Manufacturer & Models	Sensor Connector	REF# OEM	REF# UNIMED	Sensor Descriptions	Price (unit)	Ext - Cable	Monitor End Conn.	Sensor End Conn.
<b>Zondan</b>								
Apollo N2 Apollo N4 Apollo N5 DS120C	 6-pin lemo connector, 1 notch		<b>U110-45</b>	Pediatric finger clip, 3.0m	C8	Direct		
			<b>U110S-45</b>	Pediatric soft tip, 3.0m	C8			
			<b>U210S-45</b>	Infant soft tip, 3.0m	C8			
			<b>U310-45</b>	Neonate wrap, 3.0m	C8			
			<b>U410-45</b>	Adult finger clip, 3.0m	C7			
			<b>U410S-45</b>	Adult soft tip, 3.0m	C8			
			<b>U610-45</b>	Adult/Neonate wrap, 3.0m	C7			
			<b>U610B-45</b>	Pediatric/Infant wrap, 3.0m	C7			
			<b>U810-45</b>	Multi-site, 3.0m	C7			
			<b>U910-45</b>	Adult ear clip, 3.0m	C8			
	 9-pin connector, Keyed	See NE-Tech (OxiSmart) U*03-01 Series Sensor	2.2m		U708-45			
ZD120B, ZD120D, ZD120E  (*Digital Tech)	 6-pin lemo connector, 1 notch		<b>U110-66D</b>	Pediatric finger clip, 3.0m	D1	Direct		
			<b>U110S-66D</b>	Pediatric soft tip, 3.0m	D1			
			<b>U210S-66D</b>	Infant soft tip, 3.0m	D1			
			<b>U310-66D</b>	Neonate wrap, 3.0m	D1			
			<b>U410-66D</b>	Adult finger clip, 3.0m	C8			
			<b>U410S-66D</b>	Adult soft tip, 3.0m	D1			
			<b>U610-66D</b>	Adult/Neonate wrap, 3.0m	C8			
			<b>U610B-66D</b>	Pediatric/Infant wrap, 3.0m	C8			
			<b>U810-66D</b>	Multi-site, 3.0m	C8			
			<b>U910-66D</b>	Adult ear clip, 3.0m	D1			
	 9-pin connector, Keyed	See Digital Tech U*03-42D Series Sensor	2.2m		U708-45			
Apollo N1/N2/N3/N4/N5  (*M-Tech)	 8-pin lemo connector, 1 notch		<b>U110-210M</b>	Pediatric finger clip, 3.0m	D2	Direct		
			<b>U110S-210M</b>	Pediatric soft tip, 3.0m	D2			
			<b>U210S-210M</b>	Infant soft tip, 3.0m	D2			
			<b>U310-210M</b>	Neonate wrap, 3.0m	D2			
			<b>U410-210M</b>	Adult finger clip, 3.0m	D1			
			<b>U410S-210M</b>	Adult soft tip, 3.0m	D2			
			<b>U610-210M</b>	Adult/Neonate wrap, 3.0m	D1			
			<b>U610B-210M</b>	Pediatric/Infant wrap, 3.0m	D1			
			<b>U810-210M</b>	Multi-site, 3.0m	D1			
			<b>U910-210M</b>	Adult ear clip, 3.0m	D2			



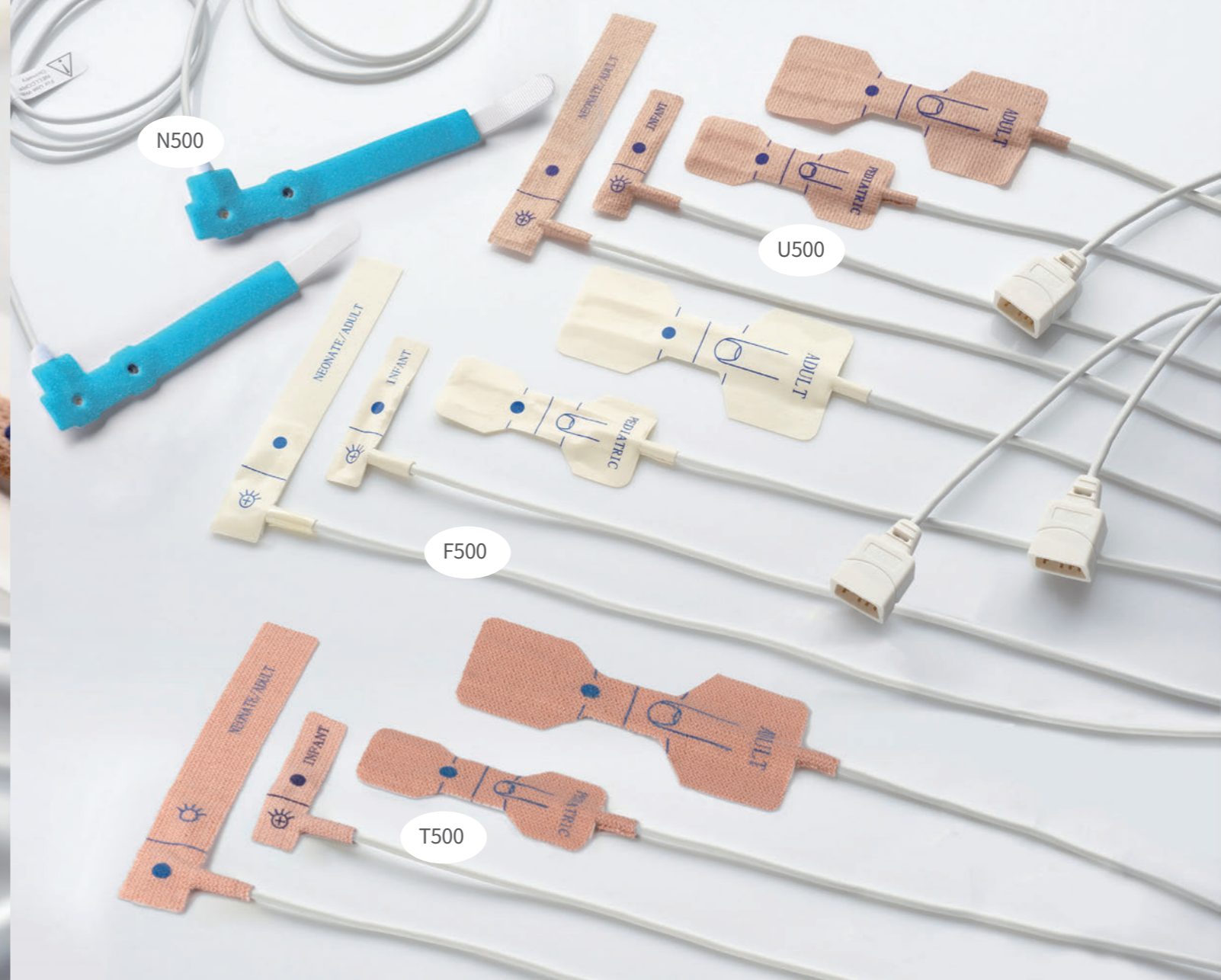

## 2 Disposable SpO<sub>2</sub> Sensor

### Compatible with major brands

- NE-Tech
- GE
- Novamatrix
- M-Tech
- BCI
- Mindray
- Datex
- Nihon Kohden
- ...

### Certificates

- FDA
- CE
- ISO 13485
- MDSAP

## 2.1 Regular disposable spo2 sensor

### Specification













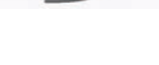

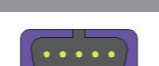

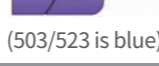
<b>Cable material</b>	PVC Jacket, white, 3.2mm diameter	<b>Connector</b>	PVC plug & Golden plated pins
<b>LED</b>	660nm/905nm/940nm/890nm	<b>Photo detector</b>	4mm/8mm (size)
<b>Cable Length</b>	0.9m	<b>Sensor tape</b> (See the above picture for Reference)	Blue non-adhesive foam (N500 series) 3M textile adhesive (U500 series) 3M white adhesive foam (F500 series) 3M Stretch fabric (T500 series)
<b>Package</b>	24 pcs per box		

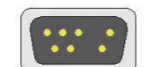

OEM Part Number	Textile Adhesive	Foam Adhesive	Non-Adhesive	Stretch Fabric	Patient Sizes	Sensor end Connector	Price (unit)
<b>BCI</b>							
1300	U503-06	F503-06	N543-06	T503-06	Adult (>40Kg)		B1
1301	U523-06	F523-06	N533-06	T523-06	Pediatric (10-50Kg)		B1
1303	U533-06	F533-06	N533-06	T533-06	Infant (3-20Kg)		B1
1302	U543-06	F543-06	N543-06	T543-06	Neonate (<3Kg)		B1
<b>Biolight Digital-Tech</b>							
	U503-62D	F503-62D	N543-62D	T503-62D	Adult (>40Kg)		B6.5
	U523-62D	F523-62D	N533-62D	T523-62D	Pediatric (10-50Kg)		B6.5
	U533-62D	F533-62D	N533-62D	T533-62D	Infant (3-20Kg)		B6.5
	U543-62D	F543-62D	N543-62D	T543-62D	Neonate (<3Kg)		B6.5
<b>Criticare/CSI</b>							
570SD	U503-05	F503-05	N543-05	T503-05	Adult (>40Kg)		B3
571SD	U523-05	F523-05	N533-05	T523-05	Pediatric (10-50Kg)		B3
572SD	U533-05	F533-05	N533-05	T533-05	Infant (3-20Kg)		B3
573SD	U543-05	F543-05	N543-05	T543-05	Neonate (<3Kg)		B3
<b>Digital-Tech</b>							
	U503-42D	F503-42D	N543-42D	T503-42D	Adult (>40Kg)		B3
	U523-42D	F523-42D	N533-42D	T523-42D	Pediatric (10-50Kg)		B3
	U533-42D	F533-42D	N533-42D	T533-42D	Infant (3-20Kg)		B3
	U543-42D	F543-42D	N543-42D	T543-42D	Neonate (<3Kg)		B3
<b>Dixtal</b>							
	U503-113	F503-113	N543-113	T503-113	Adult (>40Kg)		B2
	U523-113	F523-113	N533-113	T523-113	Pediatric (10-50Kg)		B2
	U533-113	F533-113	N533-113	T533-113	Infant (3-20Kg)		B2
	U543-113	F543-113	N543-113	T543-113	Neonate (<3Kg)		B2
<b>GE-Datex</b>							
SAS-AF	U503-09	F503-09	N543-09	T503-09	Adult (>40Kg)		B1
SAS-AP	U523-09	F523-09	N533-09	T523-09	Pediatric (10-50Kg)		B1
SAS-AP	U533-09	F533-09	N533-09	T533-09	Infant (3-20Kg)		B1
SAS-AF	U543-09	F543-09	N543-09	T543-09	Neonate (<3Kg)		B1

OEM Part Number	Textile Adhesive	Foam Adhesive	Non-Adhesive	Stretch Fabric	Patient Sizes	Sensor end Connector	Price (unit)
<b>GE- Ohmeda</b>							
	U503-02	F503-02	N543-02	T503-02	Adult (>40Kg)		B2
	U523-02	F523-02	N533-02	T523-02	Pediatric (10-50Kg)		B2
	U533-02	F533-02	N533-02	T533-02	Infant (3-20Kg)		B2
	U543-02	F543-02	N543-02	T543-02	Neonate (<3Kg)		B2
<b>GE-TruSignal+</b>							
TS-AP-10/TS-AP-24	U503-117	F503-117	N543-117	T503-117	Adult (>40Kg)		B4
TS-PAW-10/TS-PAW-24	U523-117	F523-117	N533-117	T523-117	Pediatric (10-50Kg)		B4
	U533-117	F533-117	N533-117	T533-117	Infant (3-20Kg)		B4
TS-AF-10/TS-AF-24	U543-117	F543-117	N543-117	T543-117	Neonate (<3Kg)		B4
<b>GE-OxyTip+</b>							
OXY-AP-10	U503-127	F503-127	N543-127	T503-127	Adult (>40Kg)		B4.1
	U523-127	F523-127	N533-127	T523-127	Pediatric (10-50Kg)		B4.1
	U533-127	F533-127	N533-127	T533-127	Infant (3-20Kg)		B4.1
OXY-AF-10	U543-127	F543-127	N543-127	T543-127	Neonate (<3Kg)		B4.1
<b>Mindray-Datascope</b>							
0998-00-0076-05	U503-07	F503-07	N543-07	T503-07	Adult (>40Kg)		B2
0998-00-0076-04	U523-07	F523-07	N533-07	T523-07	Pediatric (10-50Kg)		B2
0998-00-0074-03	U533-07	F533-07	N533-07	T533-07	Infant (3-20Kg)		B2
0998-00-0074-04	U543-07	F543-07	N543-07	T543-07	Neonate (<3Kg)		B2
<b>M-Tech Rainbow</b>							
2317/LNCS Adtx-3	U503-49R	F503-49R	N543-49R	T503-49R	Adult (>40Kg)		B4.1
2318/LNCS Pdtx-3	U523-49R	F523-49R	N533-49R	T523-49R	Pediatric (10-50Kg)		B4.1
2319/LNCS Inf-3	U533-49R	F533-49R	N533-49R	T533-49R	Infant (3-20Kg)		B4.1
2320/LNCS Neo-3	U543-49R	F543-49R	N543-49R	T543-49R	Neonate (<3Kg)		B4.1
1001/LNOP Adt	U503-125R	F503-125R	N543-125R	T503-125R	Adult (>40Kg)		B4.1
1025/LNOP Pdt	U523-125R	F523-125R	N533-125R	T523-125R	Pediatric (10-50Kg)		B4.1
1800/LNOP Inf-L	U533-125R	F533-125R	N533-125R	T533-125R	Infant (3-20Kg)		B4.1
1798/LNOP Neo-L	U543-125R	F543-125R	N543-125R	T543-125R	Neonate (<3Kg)		B4.1

M-Tech Rainbow Next Page

OEM Part Number	Textile Adhesive	Foam Adhesive	Non-Adhesive	Stretch Fabric	Patient Sizes	Sensor end Connector	Price (unit)
<b>M-Tech Rainbow</b>							
2509/M-LNCS Adtx-3	U503-203	F503-203	N543-203	T503-203	Adult (>40Kg)		B4.1
2511/M-LNCS Pdbx-3	U523-203	F523-203	N533-203	T523-203	Pediatric (10-50Kg)		B4.1
2513/M-LNCS Inf-3	U533-203	F533-203	N533-203	T533-203	Infant (3-20Kg)		B4.1
2515/M-LNCS Neo-3	U543-203	F543-203	N543-203	T543-203	Neonate (<3Kg)		B4.1
4000/RD SET Adt	U503-254	F503-254	N543-254	T503-254	Adult (>40Kg)		B6
4001/RD SET Pdt	U523-254	F523-254	N533-254	T523-254	Pediatric (10-50Kg)		B6
4002/RD SET Inf	U533-254	F533-254	N533-254	T533-254	Infant (3-20Kg)		B6
4003/RD SET Neo	U543-254	F543-254	N543-254	T543-254	Neonate (<3Kg)		B6
<b>NE-Tech OxiSmart</b>							
D25	U503-01	F503-01	N543-01	T503-01	Adult (>40Kg)		A8
D20	U523-01	F523-01	N533-01	T523-01	Pediatric (10-50Kg)		A8
I20	U533-01	F533-01	N533-01	T533-01	Infant (3-20Kg)		A8
N25	U543-01	F543-01	N543-01	T543-01	Neonate (<3Kg)		A8
<b>NE-Tech OxiMax</b>							
MAX-A	U503-01XP	F503-01XP	N543-01XP	T503-01XP	Adult (>40Kg)		B2
MAX-P	U523-01XP	F523-01XP	N533-01XP	T523-01XP	Pediatric (10-50Kg)		B2
MAX-I	U533-01XP	F533-01XP	N533-01XP	T533-01XP	Infant (3-20Kg)		B2
MAX-N	U543-01XP	F543-01XP	N543-01XP	T543-01XP	Neonate (<3Kg)	 (503/523 is blue)	B2
<b>Nihon Kohden</b>							
TL-271T	U503-16	F503-16	N543-16	T503-16	Adult (>40Kg)		B2
TL-272T	U523-16	F523-16	N533-16	T523-16	Pediatric (10-50Kg)		B2
TL-274T	U533-16	F533-16	N533-16	T533-16	Infant (3-20Kg)		B2
TL-273T	U543-16	F543-16	N533-16	T543-16	Neonate (<3Kg)		B2
<b>Nonin</b>							
6000CA/7000A	U503-08	F503-08	N543-08	T503-08	Adult (>40Kg)		B1
6000CP/7000P	U523-08	F523-08	N533-08	T523-08	Pediatric (10-50Kg)		B1
6000CI/7000I	U533-08	F533-08	N533-08	T533-08	Infant (3-20Kg)		B1
6000CN/7000N	U543-08	F543-08	N543-08	T543-08	Neonate (<3Kg)		B1
<b>Novamatrix</b>							
AS110	U503-03	F503-03	N543-03	T503-03	Adult (>40Kg)		B2
AS120	U523-03	F523-03	N533-03	T523-03	Pediatric (10-50Kg)		B2
AS130	U533-03	F533-03	N533-03	T533-03	Infant (3-20Kg)		B2
AS140	U543-03	F543-03	N543-03	T543-03	Neonate (<3Kg)		B2



## 2.2 C-Shape disposable spo2 sensor

### Features

1. Easy to place on finger
2. More accurate sensor positioning
3. Adhesive foam or PE breathable film option

### Specification

SpO <sub>2</sub> Accuracy Range	70-100%
Saturation Accuracy	70-89%, ±3; 90-100%, ±2 (No Motion)
Pulse Rate Accuracy	±2bpm (No Motion)
Low Perfusion	PI=0.3
Package	24 pcs/box
Sensor Tape	C-Shpae adhesive foam (CF500 series) C-Shpae PE breathable film (CP500 series)



## Order Information

OEM Model Reference	C-Shape Foam Adhesive	C-Shape Adhesive PE Breathable Film	Patient Sizes	Sensor end Connector	Price (unit)
BCI					
	CF503-06	CP503-06	Adult (>40Kg)		B1
	CF523-06	CP523-06	Pediatric (10-50Kg)		B1
Bielight Digital-Tech					
	CF503-62D	CP503-62D	Adult (>40Kg)		B6.5
	CF523-62D	CP523-62D	Pediatric (10-50Kg)		B6.5
Criticare/CSI					
	CF503-05	CP503-05	Adult (>40Kg)		B3
	CF523-05	CP523-05	Pediatric (10-50Kg)		B3
Digital-Tech					
	CF503-42D	CP503-42D	Adult (>40Kg)		B3
	CF523-42D	CP523-42D	Pediatric (10-50Kg)		B3
Dixtal					
	CF503-113	CP503-113	Adult (>40Kg)		B2
	CF523-113	CP523-113	Pediatric (10-50Kg)		B2
GE-Datex					
	CF503-09	CP503-09	Adult (>40Kg)		B1
	CF523-09	CP523-09	Pediatric (10-50Kg)		B1

## Order Information



OEM Model Reference	C-Shape Foam Adhesive	C-Shape Adhesive PE Breathable Film	Patient Sizes	Sensor end Connector	Price (unit)
GE- Ohmeda					
	CF503-02	CP503-02	Adult (>40Kg)		B2
	CF523-02	CP523-02	Pediatric (10-50Kg)		B2
GE-TruSignal+					
	CF503-117	CP503-117	Adult (>40Kg)		B4
	CF523-117	CP523-117	Pediatric (10-50Kg)		B4
GE-OxyTip+					
	CF503-127	CP503-127	Adult (>40Kg)		B4.1
	CF523-127	CP523-127	Pediatric (10-50Kg)		B4.1
Mindray-Datascope					
	CF503-07	CP503-07	Adult (>40Kg)		B2
	CF523-07	CP523-07	Pediatric (10-50Kg)		B2
M-Tech					
	CF503-49	CP503-49	Adult (>40Kg)		B1
	CF523-49	CP523-49	Pediatric (10-50Kg)		B1
M-Tech Rainbow					
	CF503-49R	CP503-49R	Adult (>40Kg)		B4.1
	CF523-49R	CP523-49R	Pediatric (10-50Kg)		B4.1
M-Tech Rainbow Next Page					



# Order Information

OEM Model Reference	C-Shape Foam Adhesive	C-Shape Adhesive PE Breathable Film	Patient Sizes	Sensor end Connector	Price (unit)
<b>M-Tech Rainbow</b>					
	CF503-203	CP503-203	Adult (>40Kg)		B4.1
	CF523-203	CP523-203	Pediatric (10-50Kg)		B4.1
	CF503-125R	CP503-125R	Adult (>40Kg)		B4.1
	CF523-125R	CP523-125R	Pediatric (10-50Kg)		B4.1
<b>NE-Tech OxiSmart</b>					
	CF503-01	CP503-01	Adult (>40Kg)		A8
	CF523-01	CP523-01	Pediatric (10-50Kg)		A8
<b>NE-Tech OxiMax</b>					
	CF503-01XP	CP503-01XP	Adult (>40Kg)		B2
	CF523-01XP	CP523-01XP	Pediatric (10-50Kg)	 (503/523 is blue 533/543 is purple)	B2
<b>Nihon Kohden</b>					
	CF503-16	CP503-16	Adult (>40Kg)		B2
	CF523-16	CP523-16	Pediatric (10-50Kg)		B2
<b>Nonin</b>					
	CF503-08	CP503-08	Adult (>40Kg)		B1
	CF523-08	CP523-08	Pediatric (10-50Kg)		B1

# Order Information

OEM Model Reference	C-Shape Foam Adhesive	C-Shape Adhesive PE Breathable Film	Patient Sizes	Sensor end Connector	Price (unit)
<b>Novamatrix</b>					
	CF503-03	CP503-03	Adult (>40Kg)		B2
	CF523-03	CP523-03	Pediatric (10-50Kg)		B2





### Compatible with Major Patient Monitor Brands

Covidien>NE tech  
 GE>Datex>Ohmeda  
 Philips  
 GE>Marquette

Spacelabs  
 Novamatrix  
 Criticare  
 Criticare

BCI  
 Mindray>Datascope  
 Nihon Kohden  
 Palco  
 ...

REF#	OEM REF#	Sensor Tech.	Cable Length	Monitor End Conn.	Sensor End Conn.	Price (unit)
<b>3F Medical</b>						
<b>U708-189</b>		NE-Tech Non-OxiMax	2.2m			C3
<b>Adecon</b>						
<b>U708-120</b>		NE-Tech OxiSmart	2.2m			C1.4
<b>Advanced Instrumentations</b>						
<b>U708-29</b>		NE-Tech OxiSmart	2.2m			B8
<b>Anke</b>						
<b>U708-37</b>		NE-Tech OxiSmart	2.2m			C2
<b>U708X-78</b>		NE-Tech OxiMax	2.2m			C4
<b>U710X-78</b>			3.0m			C5
<b>U708-82</b>		NE-Tech OxiSmart	2.2m			C3
<b>ARI Medical</b>						
<b>U708-29</b>		NE-Tech OxiSmart	2.2m			B8
<b>Armstrong</b>						
<b>U708-06</b>		NE-Tech OxiSmart	2.2m			B8
<b>Artema/S&amp;W</b>						
<b>U708-80</b>	59831-0	NE-Tech OxiSmart	2.2m			C3
<b>U708-19</b>		NE-Tech OxiSmart	2.2m			C3
<b>Baxter</b>						
<b>U708-12</b>		NE-Tech OxiSmart	2.2m			C2

## ③ SpO2 Interface Cable

### Specification

Cable material	TPU Jacket, Light gray, Blue
Connector	Nylon plug & Golden plated pins
Cable Length	1.1m/2.2m/3.0m/3.6m
Cable diameter	4.0mm/5.0mm
Package	1 pc/bag



REF#	OEM REF#	Sensor Tech.	Cable Length	Monitor End Conn.	Sensor End Conn.	Price (unit)
BCI						
U708-06	3311	NE-Tech OxiSmart	2.2m			B8
U708-76		BCI Tech	2.2m			C1
Biocare						
U708-62		Biolight Digital Tech	2.2m			C3
U708-143		NE-Tech OxiSmart	2.2m			C1
U708-29		NE-Tech OxiSmart	2.2m			B8
U708-61		Digital Tech	2.2m			C3
U708-223		NE-Tech OxiSmart	2.2m			C3
Biolight						
U708-47		NE-Tech OxiSmart	2.2m			C1.4
U708-51P		NE-Tech OxiSmart	2.2m			C8.9
U710X-51	15-100-0016	NE-Tech OxiMax	3.0m			C5
U708-62		Biolight Digital Tech	2.2m			C3
U708-68	15-027-0005	Biolight Digital Tech	2.2m			C3
U708-205		Biolight Digital Tech	2.2m			C3
U708-261		New Biolight Digital Tech	2.2m			C1.3
Bionet						
U708-58		NE-Tech OxiSmart	2.2m			C1.4
U708-108		Bionet	2.2m			C3

REF#	OEM REF#	Sensor Tech.	Cable Length	Monitor End Conn.	Sensor End Conn.	Price (unit)
Bionet						
U708-114	152600-004002	NE-Tech OxiSmart	2.2m			C3
Biosys						
U708-27		NE-Tech OxiSmart	2.2m			C3
Bruker						
U708-63		NE-Tech OxiSmart	2.2m			C3
Carewell						
U708-29		NE-Tech OxiSmart	2.2m			B8
U708-45		Digital Tech	2.2m			C1
CAS Medical						
U708M-15R		M-Tech LNCS	2.2m			D1.3
Charmcare						
U708-246		NE-Tech OxiSmart	2.2m			C4
U708-153		NE-Tech OxiSmart	2.2m			C1.4
ChoiceMMed(Beijing Choice)						
U708-96		BCI	2.2m			B8
U708-37		NE-Tech OxiSmart	2.2m			C2
U708-229		NE-Tech OxiSmart	2.2m			To be updated
Comen						
U708M-202		M-Tech LNCS	2.2m			D3
U710X-187		NE-Tech OxiMax	3.0m			C6



REF#	OEM REF#	Sensor Tech.	Cable Length	Monitor End Conn.	Sensor End Conn.	Price (unit)
<b>Comen</b>						
U708M-187		M-Tech LNCS	2.2m			C8
U708MR-187		M-Tech M-LNCS	2.2m			D3
U708-183		NE-Tech OxiSmart	3.0m			C1.3
U708-208		NE-Tech OxiSmart	2.2m			C3
U708-208D		Digital Tech	2.2m			C3
U708-208P		NE-Tech OxiSmart	2.2m			D1
U708X-208		NE-Tech OxiMax	2.2m			C4
U710X-208			3.0m			C5
U708M-208R		M-Tech LNCS Rainbow	2.2m			C8
U708MR-208		M-Tech M-LNCS Rainbow	2.2m			D3
<b>Contec</b>						
U708-29		NE-Tech OxiSmart	2.2m			B8
U708-47		Digital Tech	2.2m			C1.4
<b>Corpuls</b>						
U708M-152		M-Tech LNCS	2.2m			C3
<b>Creative</b>						
U708-29		NE-Tech OxiSmart	2.2m			B8
U708-61		Digital Tech	2.2m			C3
U710X-195		NE-Tech OxiMax	2.2m			C3.8

REF#	OEM REF#	Sensor Tech.	Cable Length	Monitor End Conn.	Sensor End Conn.	Price (unit)
<b>Criticare/CSI*</b>						
U708-05	518LD	CSI	2.2m			C7
U708-75	518DD	CSI	2.2m			B8
<b>Digicare</b>						
U708-76		BCI Tech	2.2m			C1
U708-52		NE-Tech OxiSmart	2.2m			C2
<b>Dixon</b>						
U708-205		Biolight Digital Tech	2.2m			C3
U708M-87P		M-Tech LNCS Rainbow	2.2m			D1.3
U708-29		NE-Tech OxiSmart	2.2m			B8
<b>Dixtal</b>						
U708-113		NE-Tech OxiSmart	2.2m			C3
<b>Dolphin</b>						
U708-50		Digital Tech	2.2m			C5
<b>Draeger/Dräger &gt; Siemens</b>						
U708-28	5720084/M35370	NE-Tech OxiSmart	2.2m			C4
U708-85		NE-Tech OxiSmart	2.2m			D6.7
U710-85			3.0m			D7
U704-23	3368433	NE-Tech OxiSmart	1.1m			C3
U708-23	3375834		2.2m			C4
U704X-23	MS18683	NE-Tech OxiMax *Universal (Under specific circumstances)	1.1m			C3
U708X-23			2.2m			C5
U710X-23	MS17330		3.0m			C6

Draeger/Dräger > Siemens Next Page

REF#	OEM REF#	Sensor Tech.	Cable Length	Monitor End Conn.	Sensor End Conn.	Price (unit)
Draeger/Dräger > Siemens						
U708-23P		NE-Tech OxiSmart	2.2m			D1
U704M-23R	MS24303	M-Tech LNCS Rainbow	1.1m			C5
U708M-23R			2.2m			C6
U710M-23R	MS17522		3.0m			C6.7
U704M-23PR	MS18680	M-Tech LNCS Rainbow	1.1m			C6.7
U708M-23PR			2.2m			C7
U710M-23PR	MS17041		3.0m			C8.1
U708MR-23		M-Tech LNCS Rainbow	2.2m			D3
U708-33	4533840	NE-Tech OxiSmart	2.2m			C3
U708-29	2606487	NE-Tech OxiSmart	2.2m			B8
DRE						
U708-213		NE-Tech OxiSmart	2.2m			C6
U708X-212		NE-Tech OxiMax	2.2m			C5
U710X-212			3.0m			C6
U708-137		NE-Tech OxiSmart	2.2m			C5
U708-38		NE-Tech OxiSmart	2.2m			C2
DST						
U708-65		Digital Tech	2.2m			C1
Edan						
U708-29	M13-30691	NE-Tech OxiSmart	2.2m			B8
U708X-191		NE-Tech OxiMax	2.2m			C3
U710X-191			3.0m			C4

REF#	OEM REF#	Sensor Tech.	Cable Length	Monitor End Conn.	Sensor End Conn.	Price (unit)
Fukuda Denshi						
U708-70		NE-Tech OxiMax	2.2m			C5
U710-70			3.0m			C6
FJBF						
U708-134		Digital Tech	2.2m			C1
GE Healthcare (Corometrics/ Datex Ohmeda/Critikon)						
U708-21		NE-Tech OxiSmart	2.2m			C3
U710-21	2006644-001		3.0m			C4
U708X-21		NE-Tech OxiMax	2.2m			C6.7
U710X-21	2021406-001		3.0m			C7
U704M-21R	2430/LNC-4-GE	M-Tech LNCS Rainbow	1.1m			C4
U708M-21R			2.2m			C5
U710M-21R	2027263-002 2016/LNC-10-GE		3.0m			C6
U704MR-21	2655/M-LNC-4-GE	M-Tech M-LNCS Rainbow	1.1m			C8.6
U708MR-21			2.2m			C8.9
U710MR-21	2533/M-LNC-10-GE		3.0m			D1
U704M-21PR	2017002-002	M-Tech LNCS Rainbow	1.1m			C6.7
U708M-21PR	2017002-003(2.4m) 20169041-001		2.2m			C7
U710M-21PR	2017002-001		3.0m			C8.1
U711M-21PR	1890/PC-12-GE		3.6m			C8.2
U708-111		GE TruSignal	2.2m			C5
U710-111	TS-G3		3.0m			C6
U708-121		GE OxyTip+	2.2m			C6.7
U710-121	OXY-ES3		3.0m			C7
U711M-21RD	RD-4084(1.5m) RD-4085(3.6m) RD SET GE-05/4084(1.5m) RD SET GE-12/4085(3.6m)	M-Tech RD SET	3.6m			D2
U708-09		Datex Tech	2.2m			C4
U710-09	OXY-C3		3.0m			C5
U708-119		GE TruSignal	2.2m			C5
U710-119	TS-N3		3.0m			C6

GE Healthcare (Corometrics/ Datex Ohmeda/Critikon) Next Page

REF#	OEM REF#	Sensor Tech.	Cable Length	Monitor End Conn.	Sensor End Conn.	Price (unit)
GE Healthcare (Corometrics/ Datex Ohmeda/Critikon)						
U708-209		GE OxyTip+	2.2m			C5
U710-209	OXY-SL3		3.0m			C6
U708-25		NE-Tech OxiSmart	2.2m			C4
U710-25	4033CAX		3.0m			C5
U708-72		Ohmeda Tech	2.2m			C2
U708-112		GE TruSignal	2.2m			C5
U710-112	TS-H3		3.0m			C6
U708-102		GE OxyTip+	2.2m			C4
U710-102	OXY-OL3		3.0m			C5
U708-116		GE TruSignal	2.2m			C6
U710-116	TS-M3		3.0m			C6.7
U708-160		GE OxyTip+	2.2m			C6.7
U710-160	OXY-MC3		3.0m			C7
U708-70		NE-Tech OxiMax	2.2m			C5
U710-70	2008773-001		3.0m			C6
U708-69		NE-Tech OxiSmart	2.2m			C3
U710-69	SCP-10		3.0m			C4
U708M-15R		M-Tech LNCS	2.2m			D1.3
U710M-15R	2027263-001		3.0m			D1.5
U708-55		NE-Tech OxiSmart	2.2m			C2
U701-81	OXY-SLC	GE OxyTip+ (DATEX→OxyTip+)	0.3m			C3
U708-81	OXY-SLA		3.0m			C5
General Meditech						
U708-65		Digital Tech	2.2m			C1
U708-37		NE-Tech OxiSmart	2.2m			C2

REF#	OEM REF#	Sensor Tech.	Cable Length	Monitor End Conn.	Sensor End Conn.	Price (unit)
Guoteng						
U708-179		NE-Tech OxiSmart	2.2m			C1
Heal Force						
U708-37		NE-Tech OxiSmart	2.2m			C2
U708-61		Digital Tech	2.2m			C3
HwaTime						
U708-175		NE-Tech OxiSmart	2.2m			C1
Huntleigh						
U710-70	320325-1	NE-Tech OxiMax	3.0m			C6
Infinium						
U708-97		Digital Tech	2.2m			C3
U708-137		Digital Tech	2.2m			C5
U708-147		NE-Tech OxiSmart	2.2m			B8
Innocare						
U708-204		NE-Tech OxiSmart	2.2m			C1.4
Invivo						
U708-14		NE-Tech OxiSmart	2.2m			C7
U708M-14		M-Tech LNCS	2.2m			C3
Ivy Biomedical						
U708-85		NE-Tech OxiSmart	2.2m			D6.7
U708M-15R		M-Tech LNCS	2.2m			D1.3

Ivy Biomedical Next Page



REF#	OEM REF#	Sensor Tech.	Cable Length	Monitor End Conn.	Sensor End Conn.	Price (unit)
Ivy Biomedical						
U708-70		NE-Tech OxiMax	2.2m			C5
IBIO R&DT						
U708-100		NE-Tech OxiSmart	2.2m			C1
Jeteem						
U708-174		NE-Tech OxiSmart	2.2m			C3
Jumbor						
U708-37		NE-Tech OxiSmart	2.2m			C2
Kontron						
U708-29		NE-Tech OxiSmart	2.2m			B8
U708-53		NE-Tech OxiSmart	2.2m			C1.4
U708-13		NE-Tech OxiSmart				C3
LG Medical Design						
U708-65		Digital Tech	2.2m			C1
Lutech						
U708-45		Digital Tech	2.2m			C1
M-Tech						
U704M-125P	1619/PC04-EXT(3.6m)	M-Tech LNOP	1.1m			C4
U701M-125	1816	M-Tech LNCS LNCS → PC	0.3m			C1
U704M-49	2021/LNC-4-Ext	M-Tech LNCS	1.1m			B8
U704M-49P	1645/MAC-1(0.45m)	M-Tech LNOP	1.1m			C2

M-Tech Next Page

REF#	OEM REF#	Sensor Tech.	Cable Length	Monitor End Conn.	Sensor End Conn.	Price (unit)
M-Tech						
U701MR-49		M-Tech M-LNCS	0.3m			C6.7
U704M-49RD	4105(0.45m) 4089(0.9m)	M-Tech RD SET RD SET → LNCS	1.1m			D1.3
U701M-254R	4092	M-Tech LNCS LNCS → RD SET	0.3m			C3
☆ U704M-254RD	4095/RD SET EXT-4	M-Tech RD SET (RD SET Extension)	1.1m			D1
☆ U704M-254PR	4091(0.45m)	M-Tech LNOP LNOP → RD SET	1.1m			C7
☆ U704MR-273	Rainbow M20-01 (0.45m)	M-Tech M-LNCS M-LNCS → M20	1.1m			D1

Reserved

M-Tech Next Page

REF#	OEM REF#	Sensor Tech.	Cable Length	Monitor End Conn.	Sensor End Conn.	Price (unit)
<b>M-Tech</b>						
<b>U704M-15PR</b>	1173/PC04	M-Tech LNOP Rainbow	1.1m			D2
<b>U708M-15PR</b>	1005/PC08		2.2m			D3
<b>U711M-15PR</b>	1006/PC12		3.6m			D3.4
<b>U701MR-15</b>	2523/M-LNC-1	M-Tech M-LNCS Rainbow	0.3m			DD1.3
<b>U704MR-15</b>	2524/M-LNC-4		1.1m			DD1.7
<b>U708MR-15</b>			2.2m			D4
<b>U710MR-15</b>	2525/M-LNC-10		3.0m			D4.1
<b>U712MR-15</b>	2526/M-LNC-14		4.0m			D4.4
<b>U701M-15R</b>	2364/LNC-1	M-Tech LNCS Rainbow	0.3m			C8.7
<b>U704M-15R</b>	2017/LNC-4		1.1m			D1
<b>U708M-15R</b>			2.2m			D1.3
<b>U710M-15R</b>	1814/LNC-10		3.0m			D1.5
<b>U712M-15R</b>	2013/LNC-14		4.0m			D2
<b>U705M-15RD</b>	4080/MD14-05	M-Tech RD SET	1.5m			<b>C8.3</b>
<b>U708M-15RD</b>	4108/MD14-08		2.2m			<b>C8</b>
<b>U711M-15RD</b>	4081/MD14-12		3.6m			C8.7
<b>U704M-87P</b>	2058/Red PC-04	M-Tech LNOP Rainbow	1.1m			D1
<b>U708M-87P</b>	2059/Red PC-08		2.2m			D1.3
<b>U711M-87P</b>	2060/Red PC-12		3.6m			D1.6
<b>U701MR-87</b>	2405/Rainbow RC-1	M-Tech M-LNCS Rainbow	0.3m			D3.5
<b>U704MR-87</b>	2406/Rainbow RC-4		1.2m			D3.8
<b>U708MR-87</b>			2.2m			DD1
<b>U711MR-87</b>	2404/Rainbow RC-12		3.6m			DD1.3
<b>U701M-87</b>	2365/Red LNC-01	M-Tech LNCS Rainbow	0.3m			C8.3
<b>U704M-87</b>	2055/Red LNC-04		1.2m			C8.7
<b>U708M-87</b>			2.2m			D1
<b>U710M-87</b>	2056/Red LNC-10		3.0m			D1.3
<b>U712M-87</b>	2057/Red LNC-14		4.0m			D1.6

M-Tech Next Page

REF#	OEM REF#	Sensor Tech.	Cable Length	Monitor End Conn.	Sensor End Conn.	Price (unit)
<b>M-Tech</b>						
<b>U708M-87RD</b>	4102/MD20-1.5(0.45m)	M-Tech RD SET	2.2m			C8
<b>U710M-87RD</b>	4103-MD20-05(1.5m)		3.0m			D1
<b>U711M-87RD</b>	4104/MD20-12		3.6m			D1.3
<b>MDE</b>						
<b>U708M-15R</b>		M-Tech LNCS	2.2m			D1.3
<b>MedChoice</b>						
<b>U708-97</b>		Digital Tech	2.2m			C3
<b>Medec</b>						
<b>U708-29</b>		NE-Tech OxiSmart	2.2m			B8
<b>Mediana</b>						
<b>U708-70</b>		NE-Tech OxiMax	2.2m			C5
<b>Mediblu</b>						
<b>U708-65</b>		Digital Tech	2.2m			C1
<b>U708-37</b>		NE-Tech OxiSmart	2.2m			C2
<b>Medtronic &gt; Physio Control</b>						
<b>U708M-15R</b>		M-Tech LNCS	2.2m			D1.3
<b>Medlab</b>						
<b>U708-76</b>		BCI Tech	2.2m			C1
<b>MEK</b>						
<b>U708-56</b>		NE-Tech OxiSmart	2.2m			C3
<b>U708-27</b>		NE-Tech OxiSmart	2.2m			C3
<b>U708-249</b>		NE-Tech OxiSmart	2.2m			C3

REF#	OEM REF#	Sensor Tech.	Cable Length	Monitor End Conn.	Sensor End Conn.	Price (unit)
<b>Mennen</b>						
U708-54		NE-Tech OxiSmart	2.2m			C3
U708-85		NE-Tech OxiSmart	2.2m			D6.7
U708-24		NE-Tech OxiSmart	2.2m			D3.5
U708X-59		NE-Tech OxiMax	2.2m			C4
U710X-59			3.0m			C5
U708M-59		M-Tech LNCS	2.2m			C3
<b>Mindray &gt; Datascope</b>						
U708-07	0012-00-0516-01 0012-00-0516-02	Datascope	2.2m			C3
U704M-15R	0012-00-1652	M-Tech LNCS Rainbow	1.1m			D1
U708M-15R			2.2m			D1.3
U710M-15R	0012-00-1599		3.0m			D1.5
U712M-15R	0012-00-1653		4.0m			D2
U708-69		NE-Tech OxiSmart	2.2m			C3
U710-69	0012-00-1254		3.0m			C4
U708-70		NE-Tech OxiMax	2.2m			C5
U710-70	0012-00-1464		3.0m			C6
U704-01	0010-20-43075	DPM SpO2 NE-Tech OxiSmart	1.1m			C1.4
U704-29	040-001274-00	DPM SpO2 NE-Tech OxiSmart	1.1m			B7
U708-29	561A/0010-20-42594		2.2m			B8
U708M-29		M-Tech LNCS	2.2m			B8
U708-29M		NE-Tech OxiSmart	2.2m			C6

REF#	OEM REF#	Sensor Tech.	Cable Length	Monitor End Conn.	Sensor End Conn.	Price (unit)
<b>Mindray &gt; Datascope</b>						
U708M-30	115-023136-00	M-Tech LNCS	2.2m			B8
U708-30M		NE-Tech OxiSmart	2.2m			B8
U708X-180	571B/0010-20-42595	NE-Tech OxiMax	2.2m			C2
U710X-180			3.0m			C3
U708-22	0515-30-11221 0010-30-42737	NE-Tech OxiSmart	2.2m			C1
U708M-22	0010-30-12452	M-Tech LNCS	2.2m			C1
U708-22M		NE-Tech OxiSmart	2.2m			C1
U704-48	562B/040-001443-00	DPM SpO2 NE-Tech OxiSmart	1.1m			B8
U708-48	562A/0010-20-42710		2.2m			C1.3
U708X-48	0010-20-42712	NE-Tech OxiMax	2.2m			C3
U710X-48			3.0m			C4
U708M-48R	115-020768-00 040-000332-00	M-Tech LNCS Rainbow	2.2m			C4
U708M-48	0010-30-42738 115-023135-00	M-Tech LNCS	2.2m			C3
U710M-48RD	040-003310-00/583A RD SET MR-10	M-Tech RD SET	3.0m			D1.3
<b>M&amp;B/Mbelec</b>						
U708-92		NE-Tech OxiSmart	2.2m			C2
U708X-92		NE-Tech OxiMax	2.2m			C4
U710X-92			3.0m			C5
U708-275		NE-Tech OxiSmart	2.2m			C8.3
<b>NCC</b>						
U708-241		NE-Tech OxiSmart	2.2m			D1.3



REF#	OEM REF#	Sensor Tech.	Cable Length	Monitor End Conn.	Sensor End Conn.	Price (unit)
<b>NE-Tech</b>						
U704-70	DOC-4	NE-Tech OxiMax	1.1m			C4
U708-70			2.2m			C5
U710-70	DOC-10		3.0m			C6
U708-70P		NE-Tech OxiSmart	2.2m			C8.1
U708-69		NE-Tech OxiSmart	2.2m			C3
U710-69	SCP-10/MC-1		3.0m			C4
U708-01		NE-Tech OxiSmart	2.2m			C3
U704-71	DEC-4	NE-Tech OxiMax	1.1m			B8
U708-71	DEC-8		2.2m			B8.1
U701-01P		NE-Tech OxiSmart (OxiMax→OxiSmart)	0.3m			C3
U708-01P			2.2m			C4
<b>Newtech</b>						
U708-173		Digital Tech	2.2m			C1
U708-167		NE-Tech OxiSmart	2.2m			C1
<b>Nihon Kohden</b>						
U708-36		Nihon Kohden	2.2m			C6.7
U710-36	JL-900P		3.0m			C7
U708X-36		NE-Tech OxiMax	2.2m			C6.7
U710X-36	JL-650P		3.0m			C7
U708M-36		M-Tech LNCS	2.2m			C6.7
U710M-36	JL-631P/K937		3.0m			C7
U708M-36R		M-Tech LNCS Rainbow	2.2m			D1
U711M-36RD	4192/RD SET NK-12	M-Tech RD SET	3.6m			C8.7
U708-106		Nihon Kohden	2.2m			C6.7
U710-106	JL-302T		3.0m			C7

Nihon Kohden Next Page

REF#	OEM REF#	Sensor Tech.	Cable Length	Monitor End Conn.	Sensor End Conn.	Price (unit)
<b>Nihon Kohden</b>						
U708-16		Nihon Kohden	2.2m			C7
U708-224	SLZ106 JL-701P	Nihon Kohden	2.2m			C7
U708X-133	NK-OEM-10 OEM-10	NE-Tech OxiMax	2.2m			C7
U710X-133			3.0m			C8.3
U708-69	NK-SCP-10	NE-Tech OxiSmart	2.2m			C3
<b>Nonin</b>						
U708-08L		Nonin	2.2m			C6
U708-08		Nonin	2.2m			C6.7
<b>Novamatrix</b>						
U708-03		Novamatrix				C1
<b>Oridion</b>						
U708-70		NE-Tech OxiSmart	2.2m			C5
<b>PaceTech</b>						
U708-39		NE-Tech OxiSmart	2.2m			DD1.5
<b>Palco</b>						
U708-148		NE-Tech OxiSmart	2.2m			C2
<b>Philips</b>						
U708-20	M1900A M1900B	NE-Tech OxiSmart	2.2m			C3
U708-40	M1940A M1940B	Philips	2.2m			C3
U708-41	M1941A/M1941B 989803105681	Philips	2.2m			C3

Philips Next Page

REF#	OEM REF#	Sensor Tech.	Cable Length	Monitor End Conn.	Sensor End Conn.	Price (unit)
Philips						
U704-43	M1943A	NE-Tech OxiSmart	1.1m			C2
U708-43			2.2m			C3
U710-43	M1943AL		3.0m			C3.8
U708X-43		NE-Tech OxiMax	2.2m			C6.7
U710X-43	M1943NL		3.0m			C7
U704M-43	2281/LNC MP4	M-Tech LNCS	1.1m			C2
U708M-43			2.2m			C3
U710M-43	2281/LNC MP10 989803148221		3.0m			C3.8
U708M-43P		M-Tech LNOP	2.2m			C5
U711M-43P	2282/LNOP MP12 M1020-61100/ 451261000761		3.6m			C6
U708-43M		NE-Tech OxiSmart	2.2m			C3
U708M-43R		M-Tech LNCS Rainbow	2.2m			C6
U710M-43R	1902/LNC-10 P8		3.0m			C6.7
U708MR-43		M-Tech M-LNCS Rainbow	2.2m			D3
U710MR-43	2352/M-LNC-10 P8		3.0m			D3.2
U708M-43PR		M-Tech LNOP Rainbow	2.2m			C7
U710M-43PR	1847/LNOP PC-12 P8		3.0m			C8.2
U711M-43RD	989803206901[1.5m] 989803206911[3.6m] 4082/RD SET MP-05[1.5m] 4083/RD SET MP-12[3.6m]	M-Tech RD SET	3.6m			D1
U710M-270R	989803186531[1.2m] 989803186501[3.0m] 3935/RED 25 LNC-1[0.3m] 3630/RED 25 LNC-4[1.2m] 3345/RED 25 LNC-10[3.0m]	M-Tech LNCS Rainbow	3.0m			D3.5
U710MR-270	989803182421[1.2m] 989803186471[3.7m] 3933/RC25-1[0.3m] 3628/RC25-4[1.2m] 3342/RC25-12[3.7m]	M-Tech M-LNCS Rainbow	3.0m			DD2
U710M-270RD	989803206931[3.7m] 4074/R25-1.5[0.5m] 4076/R25-05[1.5m] 4106/R25-08[2.4m] 4078/R25-12[3.7m]	M-Tech RD SET	3.0m			D4.3

REF#	OEM REF#	Sensor Tech.	Cable Length	Monitor End Conn.	Sensor End Conn.	Price (unit)
Philips > Goldway						
U708-37		NE-Tech OxiSmart	2.2m			C2
U708-38		NE-Tech OxiSmart	2.2m			C2
U708X-38		NE-Tech OxiMax	2.2m			C4
U710X-38			3.0m			C3
U708-11		NE-Tech OxiSmart	2.2m			C8.2
U708-61		Digital Tech	2.2m			C3
Risingsmed						
U708-217		NE-Tech OxiSmart	2.2m			C2
Schiller						
U708-17		NE-Tech OxiSmart	2.2m			C3
U708M-17		M-Tech LNCS	2.2m			C2
U708-17M		NE-Tech OxiSmart	2.2m			C2
U708-63		NE-Tech OxiSmart	2.2m			C3
U708M-63		M-Tech LNCS	2.2m			C3
U708-63M		NE-Tech OxiSmart	2.2m			C7
U708M-63R		M-Tech LNCS Rainbow	2.2m			C4
U708X-63		NE-Tech OxiMax	2.2m			C6
U710X-63			3.0m			C7

REF#	OEM REF#	Sensor Tech.	Cable Length	Monitor End Conn.	Sensor End Conn.	Price (unit)
Spacelabs						
U708-03		Novamatrix	2.2m			C1
U708-04	700-0002-00	NE-Tech OxiSmart	2.2m			C3
U710-04			3.0m			C4
U708-74		NE-Tech OxiSmart	2.2m			C7
U710-74	700-0030-00		3.0m			C8.1
U708X-74		NE-Tech OxiMax	2.2m			C8.2
U710X-74	700-0792-00		3.0m			C8
U708-74P		NE-Tech OxiSmart	2.2m			C8.9
U708M-74		M-Tech LNCS	2.2m			C7
U710M-74	700-0906-00 700-0906-01		3.0m			C8.1
U708M-74P		M-Tech LNOP	2.2m			C8.1
U710M-74P	700-0906-00 700-0906-01		3.0m			C8.3
U708M-74R		M-Tech LNCS	2.2m			C8.6
U710M-74R	2432/LNC-SL-10	Rainbow	3.0m			C8.9
U708M-74RP		M-Tech LNOP	2.2m			D1
U711M-74RP	2433/LNOP PC-SL-12	Rainbow	3.6m			D1.3
U708MR-74		M-Tech LNOP	2.2m			D3.5
U710MR-74	2714/M-LNC-SL-10	Rainbow	3.0m			D3.8
U711M-74RD	010-1649-00 4087/RD SET SL-12	M-Tech RD SET	3.6m			D3.5
U701-04NV	175-0646-00/6139-00	Novamatrix	0.3m			C3
U701-74NV	700-0029-00	Novamatrix	0.3m			C7

REF#	OEM REF#	Sensor Tech.	Cable Length	Monitor End Conn.	Sensor End Conn.	Price (unit)
Triton						
U708-135		NE-Tech OxiSmart	2.2m			C3
U708-236		NE-Tech OxiSmart	2.2m			C7
Unicare						
U708-45		Digital Tech	2.2m			C1
Uray						
U708-143		NE-Tech OxiSmart	2.2m			C1
UTAS						
U708-129		NE-Tech OxiSmart	2.2m			C1.4
Welch Allyn						
U704X-104	001966-E (PIC 40 Defibrillator PIC 50 Defibrillator)	NE-Tech OxiMax	1.1m			C7
U704-104	00195-U (PIC 40 Defibrillator PIC50 Defibrillator)	NE-Tech OxiSmart	1.1m			C7



## 4 Accessories



REF#	Product Name	Purpose of Use	Package	Price (unit)	Figures
Y04-E041	Ear sensor hanger	Used with Unimed ear clip sensor U900 series or Other brands ear sensor(Gray)	1pc	A5/pc	A
UEC-01	Adult ear clip Animal lingual clip, small size	Used with D-YS or Unimed U800 sensor(Black)	1pc	A6/pc	B
UVC-01	Animal lingual clip, big size	Used with D-YS or Unimed U800 sensor(Gray)	1pc	A5/pc	C
UVC-02	Animal lingual clip, middle size	Used with D-YS or Unimed U800 sensor(Gray)	1pc	A7/pc	D
Y04-E019	Reusable silicon y sensor wrap tape	Used with NE tech D-YS or Unimed U800 series sensors	1pc	A6/pc	E
E023-12	Reusable 3 holes foam tape for all patient sizes	Used with NE tech D-YS or Unimed U800 series sensors	12pcs/bag	B5/bag	F
E024-25	Disposable 3M adhesive textile tape for adult and neonate	Used with NE tech D-YS or Unimed U800 series sensors	25pcs/bag	B7/bag	G
E025-25	Disposable 3M adhesive textile tape for pediatric and infant	Used with NE tech D-YS or Unimed U800 series sensors	25pcs/bag	B7/bag	H
T002-12	Velcro foam wrap tape	To fix the sensor cable onto the patient	12pcs/bag	C1.4/bag	I
U037-12	Disposable Foam Cable Wrap	To fix the sensor cable onto the patient	12pcs/bag	B5/bag	J
DPTA-24N	SensorMate Disposable Positioning Tapes for Adult Size	Unimed U800 series sensors	24pcs/box	A5/pc	K
DPTN-24N	SensorMate Disposable Positioning Tapes for Infant/Neonate Size	Unimed U800 series sensors	24pcs/box	A5/pc	L
DPTP-24N	SensorMate Disposable Positioning Tapes for Pediatric Size	Unimed U800 series sensors	24pcs/box	A5/pc	M

## 5 SpO<sub>2</sub> Adapter

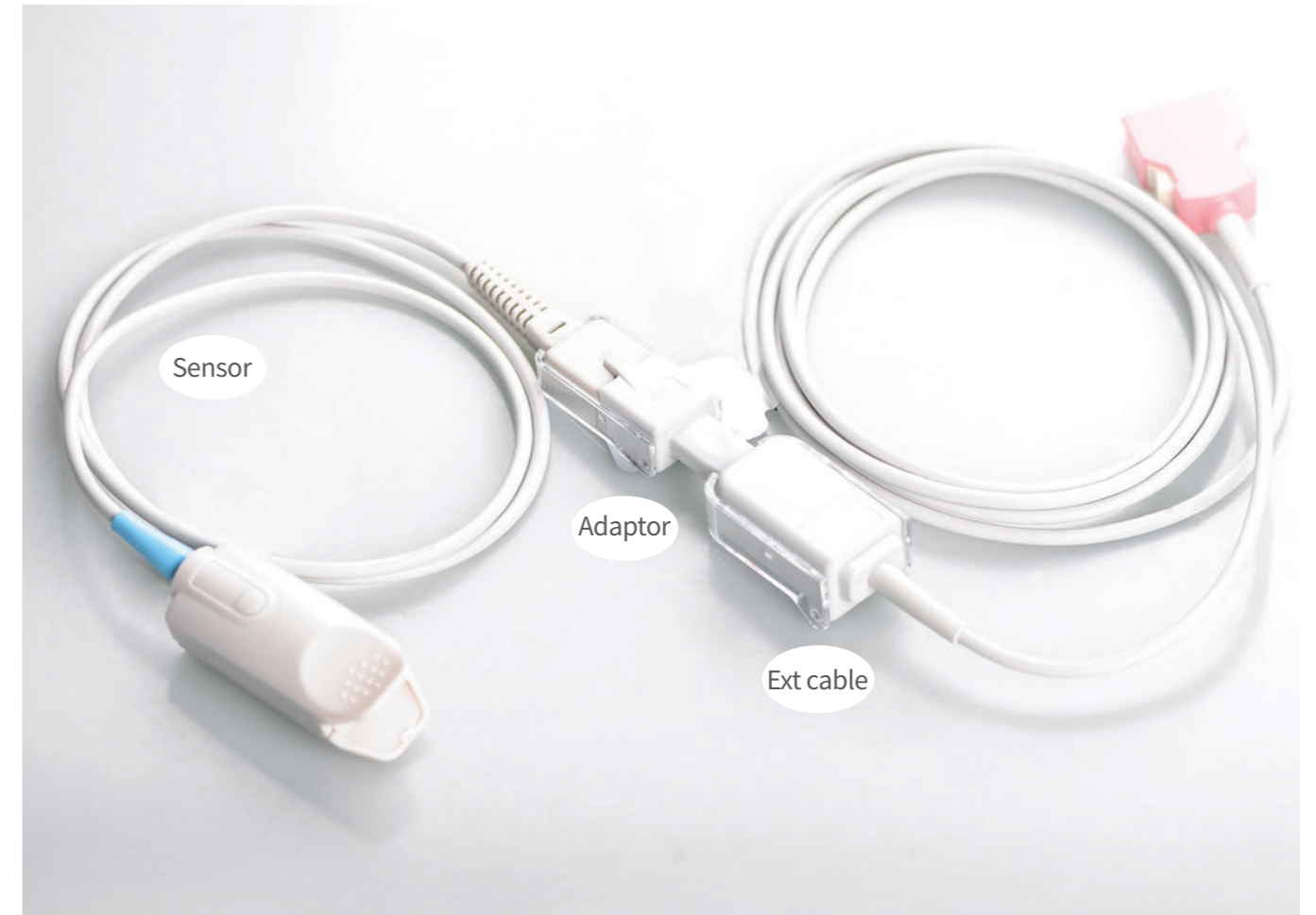





REF#	Product Name	Purpose of Use	Package	Price (unit)	Notes
U700-01P-05	SpO <sub>2</sub> Adapter (NE-Tech OxiMax to NE-Tech Non-OxiMax)	Purpose for NE-Tech OxiMax oximetry being used with NE-Tech Non-OxiMax sensors.	5pcs/box	D7	A
U700-49R-05	SpO <sub>2</sub> Adapter (M-Tech Rainbow to NE-Tech Non-OxiMax)	Purpose for M-Tech Rainbow oximetry being used with NE-Tech Non-OxiMax sensors.	5pcs/box	D7	B

A: Purpose for NE-Tech OxiMax oximetry being used with NE-Tech Non-OxiMax sensors.

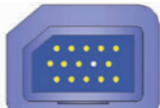
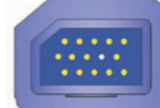
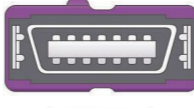
B: Purpose for M-Tech Rainbow oximetry being used with NE-Tech Non-OxiMax sensors.

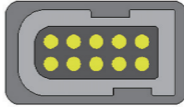
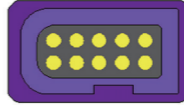
OEM Manufacturer & Models	Monitor End Conn.	Package(Ext-Cable + Adapter)				
		Package No.	Price (unit)	Ext-Cable No.	Adapter No.	Compatible with sensor (NE-Tech Non-OxiMax Sensor)
<b>Biolight</b>						
Anyview A3 (M-Tech)		U708N-87M	D4.3	U708M-87	U700-49R	Reusable or Disposable -01 Series
BLTM8500 (NE-Tech OxiMax)		U710N-51X	D3.5	U710X-51	U700-01P	Reusable or Disposable -01 Series
<b>Comen (China)</b>						
C20,C60,C80,C90 (M-Tech)		U708N-208MR	DD1.7	U708M-208R	U700-49R	Reusable or Disposable -01 Series
C20,C60,C80,C90 (NE-Tech OxiMax)		U708N-208X	D3.2	U708X-208	U700-01P	Reusable or Disposable -01 Series
<b>GE Healthcare</b>						
Dash3000/4000/5000 Solar8000/8000M Solar 8000i/9500 B20i/B40i/B60i//B650 (M-Tech)		U708N-21MR	D3.4	U708M-21R	U700-49R	Reusable or Disposable -01 Series
Dash3000/4000/5000 Solar8000/8000M Solar 8000i/9500 B20i/B40i/B60i//B650 (NE-Tech OxiMax)		U710N-21X	DD1	U710X-21	U700-01P	Reusable or Disposable -01 Series
<b>Mindray(China)</b>						
elite V5/V6/V8 IMEC,UMEC,IPM T series ,IT20,iM20, (M-Tech)		U708N-48MR	D3.2	U708M-48R	U700-49R	Reusable or Disposable -01 Series
MEC,IMEC,UMEC,IPM T series (NE-Tech OxiMax)		U710N-48X	D3.2	U710X-48	U700-01P	Reusable or Disposable -01 Series
<b>M tech</b>						
new Redical-7,Rad-8,Red-87 (M-Tech)		U708N-87M	D4.3	U708M-87	U700-49R	Reusable or Disposable -01 Series
Old RAD-5,RAD-5V (M-Tech)		U708N-15MR	D4.4	U708M-15R	U700-49R	Reusable or Disposable -01 Series

OEM Manufacturer & Models	Monitor End Conn.	Package(Ext-Cable + Adapter)				
		Package No.	Price (unit)	Ext-Cable No.	Adapter No.	Compatible with sensor (NE-Tech Non-OxiMax Sensor)
<b>Nihon Kohden</b>						
BSM-1700 Series PVM-2700 Series* BSM-3500 Series BSM-6000 Series (M-Tech)		U710N-36MR	D4.4	U710M-36R	U700-49R	Reusable or Disposable -01 Series
BSM-1700 Series PVM-2700 Series* BSM-3500 Series BSM-6000 Series (NE-Tech OxiMax)		U710N-36X	DD1	U710X-36	U700-01P	Reusable or Disposable -01 Series
<b>NE tech</b>						
N Series (NE-Tech OxiMax)		U708N-70X	D3.5	U708-70	U700-01P	Reusable or Disposable -01 Series
<b>Philips</b>						
MP20/30/40/ PM50/60/70/90 VN4,VM6,VM8 (NE-Tech OxiMax)		U710N-43X	DD1	U710X-43	U700-01P	Reusable or Disposable -01 Series
<b>Spacelabs</b>						
Ultraview (M-Tech)		U708N-74MR	DD1.9	U708M-74R	U700-49R	Reusable or Disposable -01 Series
Ultraview (NE-Tech OxiMax)		U710N-74X	DD1.7	U710X-74	U700-01P	Reusable or Disposable -01 Series
<b>Siemens</b>						
Infinity Delta/Gamma/Kappa/ MultiMed Pod/Vista (M-Tech)		U708N-23MR	D3.8	U708M-23R	U700-49R	Reusable or Disposable -01 Series
Sirecust 1281 Monitor SC 6002XL,SC7000, SC9000XL (NE-Tech OxiMax)		U710N-23X	D3.8	U710X-23	U700-01P	Reusable or Disposable -01 Series



# 6 New style SpO2 Sensor(Adult Finger Clip)











High Performance, High Flexibility, High Accuracy, More comfortable

-   
 TPU jacket
-   
 ABS shell
-   
 Latex-free
-   
 Gold plated pins
-   
 Silicone Shield

## Product Features

- Ergonomic light-weight design to offer painless and supreme comfort to the patient by providing an optimal distribution of pressure.
- Accurate measurement for thicker finger or darker skin.
- Special silicone shield design against ambient light.
- Special adjustable design accommodates bigger patient's finger.
- Easy to use, efficient cleaning and disinfection.
- Bio-compatibility tests and qualified, Latex-free.

## Order Information

Unimed Code	Specification	Picture		Price
U403N-01	Nellcor OxiSmart Compatible Cable length: 1.1M Patient weight: ≥40KG Patient type: Adult			C4
U403NC-01	Nellcor OxiSmart Compatible Cable length: 1.1M Patient weight: ≥40KG Patient type: Adult <b>Adjustable hinge</b>			C4
U403L-01	Nellcor OxiSmart Compatible Cable length: 1.1M Patient weight: ≥40KG Patient type: Adult Silicone shield			C5
U403LC-01	Nellcor OxiSmart Compatible Cable length: 1.1M Patient weight: ≥40KG Patient type: Adult Silicone shield <b>Adjustable hinge</b>			C5

\* The Price of U403-01 is C3.8  
 \* New developed SpO2 sensors series are not limited to above product listed.  
 \* Please contact our sales managers or email to sales@unimed.cn for more information.





# NIBP Cuff & Accessories

- 1. Reusable NIBP Cuff** ..... 195
  - 1.1 Reusable NIBP Bladderless Cuff ..... 196
    - 1.1a Cuff without Connector ..... 196
    - 1.1b Single Tube Cuff with Connector ..... 197
    - 1.1c Double Tube Cuff with Connector ..... 199
  - 1.2 Reusable NIBP Cuff with Inflation Bag ..... 201
    - 1.2a Cuff without Connector ..... 201
    - 1.2b Single Tube Cuff with Connector ..... 202
    - 1.2c Double Tube Cuff with Connector ..... 203
- 2. Disposable NIBP Cuff** ..... 205
  - 2.1 Disposable Neonate NIBP Cuff ..... 206
    - 2.1a Disposable Neonate TPU Cuff ..... 206
    - 2.1b Disposable Neonate Soft Fiber Cuff ..... 207
  - 2.2 Disposable NIBP Soft Fiber Cuff ..... 208
    - 2.2a Disposable Single Tube Cuff ..... 208
    - 2.2 b Disposable Double Tube Cuff ..... 209
- 3. Patient NIBP Adapter Air Hose** ..... 210
- 4. NIBP Connectors & Tubing** ..... 214
  - 4.1 Universal Y Adapter ..... 215
  - 4.2 Connectors for Cuffs And Hoses ..... 217
  - 4.3 Air Tubing ..... 222
- 5. Manual Inflation System** ..... 223
  - 5.1 Reusable Cuff with Inflation System ..... 223
  - 5.2 Disposable Cuff with Inflation System ..... 223
- 6. Wall Manometer Accessories** ..... 224
  - 6.1 Inflation System with Cuff ..... 224
  - 6.2 Inflation System without Cuff ..... 225
  - 6.3 Parts ..... 225
- 7. Tourniquet** ..... 226
- 8. Phototherapy Mask** ..... 227
- 9. Pressure Infusion Bag** ..... 228

## Certification



## Compliance with

ANSI/AAMI SP10	ISO 10993-1
EN 60601-1	ISO 10993-5
ISO 15223-1	ISO 10993-10
ISO 20417	ISO 10993-23





### 1.1 Reusable NIBP Bladderless Cuff



1.1a NIBP Cuff without Connector





## 1 Reusable NIBP Cuff







### Specification

- Reusable for multiple patient use
- Gentle nylon and TPU materials cuff with 50cm tube
- Large selection of 9 types cuffs matching the different sizes patients, coded by tubing colors
- Variety of connectors to fit all major brands monitoring systems
- Convenient to use and easy to clean
- Latex free

Patient Size	Limb Circumference	Tubing Color	Package	REF# (Single Tube)	Price (unit)	REF # (Double Tubes)	Price (unit)
Large adult long	35.5-46cm	Signal violet	1 pc/bag	<b>U1889NS</b>	B3	<b>U1889ND</b>	B4.1
Large adult	35.5-46cm	Signal violet	1 pc/bag	<b>U1869NS</b>	B2	<b>U1869ND</b>	B4
Adult long	27.5-36.5cm	Dusty grey	1 pc/bag	<b>U1886NS</b>	B1	<b>U1886ND</b>	B2
Adult	27.5-36.5cm	Dusty grey	1 pc/bag	<b>U1880NS</b>	A8	<b>U1880ND</b>	B1
Small adult	20.5-28.5cm	Sky blue	1 pc/bag	<b>U1885NS</b>	A7	<b>U1885ND</b>	A8
Pediatric	13.8-21.5cm	Green	1 pc/bag	<b>U1881NS</b>	A7	<b>U1881ND</b>	A8
Infant	9-14.8cm	Red	1 pc/bag	<b>U1882NS</b>	A6	<b>U1882ND</b>	A7
Neonate	5.8-10.8cm	Light blue	1 pc/bag	<b>U1883NS</b>	A6	<b>U1883ND</b>	A7
Thigh	45-56cm	Brown	1 pc/bag	<b>U1884NS</b>	B5	<b>U1884ND</b>	B6
Package1: Adult(x2) Small adult(x1) Adult long(x1) Large adult(x1) Large adult long(x1)		Variety	Total 6 pcs	<b>U1801NS-06</b> U1880NS x 2 U1885NS x 1 U1886NS x 1 U1869NS x 1 U1889NS x 1	C8.1	<b>U1801ND-06</b> U1880ND x 2 U1885ND x 1 U1886ND x 1 U1869ND x 1 U1889ND x 1	C8.9
Package2: Adult(x1) Small adult(x1) Pediatric(x1) Adult long(x1) Large adult(x1) Thigh(x1)		Variety	Total 6 pcs	<b>U1802NS-06</b> U1880NS x 1 U1885NS x 1 U1881NS x 1 U1886NS x 1 U1869NS x 1 U1884NS x 1	C8.3	<b>U1802ND-06</b> U1880ND x 1 U1885ND x 1 U1881ND x 1 U1886ND x 1 U1869ND x 1 U1884ND x 1	D1.3



1.1b Single Tube Cuff with Connector



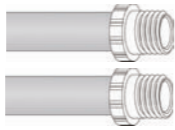
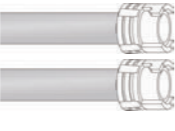
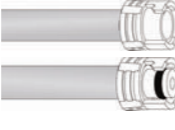

Patient Size	Limb Circumference	REF#	Cuff Connector	Tubing Color	Package	Price(unit)	
Large adult long	35.5-46cm	U1889NS-C12	For Philips Siemens Spacelabs Mindray EDAN Comen Biolight ..... 	Signal violet	1 pc/bag	B4	
Large adult	35.5-46cm	U1869NS-C12		Signal violet	1 pc/bag	B3	
Adult long	27.5-36.5cm	U1886NS-C12		Dusty grey	1 pc/bag	B2	
Adult	27.5-36.5cm	U1880NS-C12		Dusty grey	1 pc/bag	B1	
Small adult	20.5-28.5cm	U1885NS-C12		Sky blue	1 pc/bag	A8	
Pediatric	13.8-21.5cm	U1881NS-C12		Green	1 pc/bag	A8	
Infant	9-14.8cm	U1882NS-C12		Red	1 pc/bag	A7	
Neonate	5.8-10.8cm	U1883NS-C12		Light blue	1 pc/bag	A7	
Thigh	45-56cm	U1884NS-C12		Brown	1 pc/bag	B5.3	
Large adult long	35.5-46cm	U1889NS-C03		For Colin Spacelabs Datascope 	Signal violet	1 pc/bag	B4
Large adult	35.5-46cm	U1869NS-C03			Signal violet	1 pc/bag	B3
Adult long	27.5-36.5cm	U1886NS-C03			Dusty grey	1 pc/bag	B2
Adult	27.5-36.5cm	U1880NS-C03	Dusty grey		1 pc/bag	B1	
Small adult	20.5-28.5cm	U1885NS-C03	Sky blue		1 pc/bag	A8	
Pediatric	13.8-21.5cm	U1881NS-C03	Green		1 pc/bag	A8	
Infant	9-14.8cm	U1882NS-C03	Red		1 pc/bag	A7	
Neonate	5.8-10.8cm	U1883NS-C03	Light blue		1 pc/bag	A7	
Thigh	45-56cm	U1884NS-C03	Brown		1 pc/bag	B5.3	
Large adult long	35.5-46cm	U1889NS-C17			Signal violet	1 pc/bag	B4
Large adult	35.5-46cm	U1869NS-C17			Signal violet	1 pc/bag	B3
Adult long	27.5-36.5cm	U1886NS-C17			Dusty grey	1 pc/bag	B2
Adult	27.5-36.5cm	U1880NS-C17		Dusty grey	1 pc/bag	B1	
Small adult	20.5-28.5cm	U1885NS-C17		Sky blue	1 pc/bag	A8	
Pediatric	13.8-21.5cm	U1881NS-C17		Green	1 pc/bag	A8	
Infant	9-14.8cm	U1882NS-C17		Red	1 pc/bag	A7	
Neonate	5.8-10.8cm	U1883NS-C17		Light blue	1 pc/bag	A7	
Thigh	45-56cm	U1884NS-C17		Brown	1 pc/bag	B5.3	
Large adult long	35.5-46cm	U1889NS-C18			Signal violet	1 pc/bag	B4
Large adult	35.5-46cm	U1869NS-C18			Signal violet	1 pc/bag	B3
Adult long	27.5-36.5cm	U1886NS-C18			Dusty grey	1 pc/bag	B2
Adult	27.5-36.5cm	U1880NS-C18	Dusty grey		1 pc/bag	B1	
Small adult	20.5-28.5cm	U1885NS-C18	Sky blue		1 pc/bag	A8	
Pediatric	13.8-21.5cm	U1881NS-C18	Green		1 pc/bag	A8	
Infant	9-14.8cm	U1882NS-C18	Red		1 pc/bag	A7	
Neonate	5.8-10.8cm	U1883NS-C18	Light blue		1 pc/bag	A7	
Thigh	45-56cm	U1884NS-C18	Brown		1 pc/bag	B5.3	
Large adult long	35.5-46cm	U1889NS-C58	For Draeger 		Signal violet	1 pc/bag	B7
Large adult	35.5-46cm	U1869NS-C58			Signal violet	1 pc/bag	B6.7
Adult long	27.5-36.5cm	U1886NS-C58			Dusty grey	1 pc/bag	B6.6
Adult	27.5-36.5cm	U1880NS-C58		Dusty grey	1 pc/bag	B6.5	
Small adult	20.5-28.5cm	U1885NS-C58		Sky blue	1 pc/bag	B6	
Pediatric	13.8-21.5cm	U1881NS-C58		Green	1 pc/bag	B6	
Infant	9-14.8cm	U1882NS-C58		Red	1 pc/bag	B5.3	
Neonate	5.8-10.8cm	U1883NS-C58		Light blue	1 pc/bag	B5.3	
Thigh	45-56cm	U1884NS-C58	Brown	1 pc/bag	B8.1		

Patient Size	Limb Circumference	REF#	Cuff Connector	Tubing Color	Package	Price(unit)
Package1: Adult(x2) Small adult(x1) Adult long(x1) Large adult(x1) Large adult long(x1)		U1801NS-C12-06 U1880NS-C12 X2 U1885NS-C12 X1 U1886NS-C12 X1 U1869NS-C12 X1 U1889NS-C12 X1		Variety	Total 6 pcs	C8.7
		U1801NS-C03-06 U1880NS-C03 X2 U1885NS-C03 X1 U1886NS-C03 X1 U1869NS-C03 X1 U1889NS-C03 X1		Variety	Total 6 pcs	C8.7
		U1801NS-C18-06 U1880NS-C18 X2 U1885NS-C18 X1 U1886NS-C18 X1 U1869NS-C18 X1 U1889NS-C18 X1		Variety	Total 6 pcs	C8.7
Package2: Adult(x1) Small adult(x1) Pediatric(x1) Adult long(x1) Large adult(x1) Thigh(x1)		U1802NS-C12-06 U1880NS-C12 X1 U1885NS-C12 X1 U1881NS-C12 X1 U1886NS-C12 X1 U1869NS-C12 X1 U1884NS-C12 X1		Variety	Total 6 pcs	C8.9
		U1802NS-C03-06 U1880NS-C03 X1 U1885NS-C03 X1 U1881NS-C03 X1 U1886NS-C03 X1 U1869NS-C03 X1 U1884NS-C03 X1		Variety	Total 6 pcs	C8.9
		U1802NS-C18-06 U1880NS-C18 X1 U1885NS-C18 X1 U1881NS-C18 X1 U1886NS-C18 X1 U1869NS-C18 X1 U1884NS-C18 X1		Variety	Total 6 pcs	C8.9

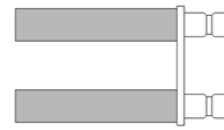
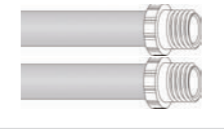
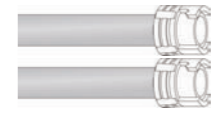

1.1c Double Tubes Cuff with Connector

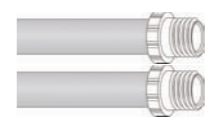
Patient Size	Limb Circumference	REF#	Cuff Connector	Tubing Color	Package	Price(unit)
Large adult long	35.5-46cm	U1889ND-C0808	For GE Corometrics GE Dianmap ..... 	Signal violet	1 pc/bag	B5
Large adult	35.5-46cm	U1869ND-C0808		Signal violet	1 pc/bag	B4.1
Adult long	27.5-36.5cm	U1886ND-C0808		Dusty grey	1 pc/bag	B3
Adult	27.5-36.5cm	U1880ND-C0808		Dusty grey	1 pc/bag	B2
Small adult	20.5-28.5cm	U1885ND-C0808		Sky blue	1 pc/bag	B1
Pediatric	13.8-21.5cm	U1881ND-C0808		Green	1 pc/bag	B1
Infant	9-14.8cm	U1882ND-C0808		Red	1 pc/bag	A8
Neonate	5.8-10.8cm	U1883ND-C0808		Light blue	1 pc/bag	A8
Thigh	45-56cm	U1884ND-C0808		Brown	1 pc/bag	B6.5
Large adult long	35.5-46cm	U1889ND-C1818		For GE Eagle/Dash/Tram/Solar ..... 	Signal violet	1 pc/bag
Large adult	35.5-46cm	U1869ND-C1818	Signal violet		1 pc/bag	B5
Adult long	27.5-36.5cm	U1886ND-C1818	Dusty grey		1 pc/bag	B4
Adult	27.5-36.5cm	U1880ND-C1818	Dusty grey		1 pc/bag	B3
Small adult	20.5-28.5cm	U1885ND-C1818	Sky blue		1 pc/bag	B2
Pediatric	13.8-21.5cm	U1881ND-C1818	Green		1 pc/bag	B2
Infant	9-14.8cm	U1882ND-C1818	Red		1 pc/bag	B1
Neonate	5.8-10.8cm	U1883ND-C1818	Light blue		1 pc/bag	B1
Thigh	45-56cm	U1884ND-C1818	Brown		1 pc/bag	B6.6
Large adult long	35.5-46cm	U1889ND-C1718	For GE Datex Ohmeda ..... 		Signal violet	1 pc/bag
Large adult	35.5-46cm	U1869ND-C1718		Signal violet	1 pc/bag	B5
Adult long	27.5-36.5cm	U1886ND-C1718		Dusty grey	1 pc/bag	B4
Adult	27.5-36.5cm	U1880ND-C1718		Dusty grey	1 pc/bag	B3
Small adult	20.5-28.5cm	U1885ND-C1718		Sky blue	1 pc/bag	B2
Pediatric	13.8-21.5cm	U1881ND-C1718		Green	1 pc/bag	B2
Infant	9-14.8cm	U1882ND-C1718		Red	1 pc/bag	B1
Neonate	5.8-10.8cm	U1883ND-C1718		Light blue	1 pc/bag	B1
Thigh	45-56cm	U1884ND-C1718		Brown	1 pc/bag	B6.6
Large adult long	35.5-46cm	U1889ND-C5858		For Drager 	Signal violet	1 pc/bag
Large adult	35.5-46cm	U1869ND-C5858	Signal violet		1 pc/bag	C3.8
Adult long	27.5-36.5cm	U1886ND-C5858	Dusty grey		1 pc/bag	C3
Adult	27.5-36.5cm	U1880ND-C5858	Dusty grey		1 pc/bag	C2
Small adult	20.5-28.5cm	U1885ND-C5858	Sky blue		1 pc/bag	C1.4
Pediatric	13.8-21.5cm	U1881ND-C5858	Green		1 pc/bag	C1.4
Infant	9-14.8cm	U1882ND-C5858	Red		1 pc/bag	C1.3
Neonate	5.8-10.8cm	U1883ND-C5858	Light blue		1 pc/bag	C1.3
Thigh	45-56cm	U1884ND-C5858	Brown		1 pc/bag	C5

Patient Size	Limb Circumference	REF#	Cuff Connector	Tubing Color	Package	Price(unit)
Large adult long	35.5-46cm	U1889ND-C48	For GE 	Signal violet	1 pc/bag	B5
Large adult	35.5-46cm	U1869ND-C48		Signal violet	1 pc/bag	B4.1
Adult long	27.5-36.5cm	U1886ND-C48		Dusty grey	1 pc/bag	B3
Adult	27.5-36.5cm	U1880ND-C48		Dusty grey	1 pc/bag	B2
Small adult	20.5-28.5cm	U1885ND-C48		Sky blue	1 pc/bag	B1
Pediatric	13.8-21.5cm	U1881ND-C48		Green	1 pc/bag	B1
Infant	9-14.8cm	U1882ND-C48		Red	1 pc/bag	A8
Neonate	5.8-10.8cm	U1883ND-C48		Light blue	1 pc/bag	A8
Thigh	45-56cm	U1884ND-C48		Brown	1 pc/bag	B6.5
		U1801ND-C0808-06 U1880ND-C0808 X2 U1885ND-C0808 X1 U1886ND-C0808 X1 U1869ND-C0808 X1 U1889ND-C0808 X1			Variety	Total 6 pcs
		Package1: Adult(x2) Small adult(x1) Adult long(x1) Large adult(x1) Large adult long(x1)		Variety	Total 6 pcs	D3.1
		U1801ND-C1818-06 U1880ND-C1818 X2 U1885ND-C1818 X1 U1886ND-C1818 X1 U1869ND-C1818 X1 U1889ND-C1818 X1		Variety	Total 6 pcs	D3.1
		U1802ND-C0808-06 U1880ND-C0808 X1 U1885ND-C0808 X1 U1881ND-C0808 X1 U1886ND-C0808 X1 U1869ND-C0808 X1 U1884ND-C0808 X1		Variety	Total 6 pcs	D2
		Package2: Adult(x1) Small adult(x1) Pediatric(x1) Adult long(x1) Large adult(x1) Thigh(x1)		Variety	Total 6 pcs	D3.4
		U1802ND-C1818-06 U1880ND-C1818 X1 U1885ND-C1818 X1 U1881ND-C1818 X1 U1886ND-C1818 X1 U1869ND-C1818 X1 U1884ND-C1818 X1		Variety	Total 6 pcs	D3.4

## 1.2 Reusable NIBP Cuff with Inflation Bag



1.2a NIBP Cuff without Connector

Patient Size	Limb Circumference	Tubing Color	Package	REF# (Single Tube)	Price(unit)	REF # (Double Tubes)	Price(unit)
Large adult long	33-47cm	Signal violet	1 pc/bag	<b>U1889S</b>	B4.1	<b>U1889D</b>	B5.3
Large adult	33-47cm	Signal violet	1 pc/bag	<b>U1869S</b>	B4	<b>U1869D</b>	B5
Adult long	25-35cm	Dusty grey	1 pc/bag	<b>U1886S</b>	B2	<b>U1886D</b>	B3
Adult	25-35cm	Dusty grey	1 pc/bag	<b>U1880S</b>	B1	<b>U1880D</b>	B2
Small adult	20-28cm	Sky blue	1 pc/bag	<b>U1885S</b>	A8	<b>U1885D</b>	B1
Pediatric	18-26cm	Green	1 pc/bag	<b>U1881S</b>	A8	<b>U1881D</b>	B1
Infant	10-19cm	Red	1 pc/bag	<b>U1882S</b>	A7	<b>U1882D</b>	A8
Neonate	6-11cm	Light blue	1 pc/bag	<b>U1883S</b>	A7	<b>U1883D</b>	A8
Thigh	46-66cm	Brown	1 pc/bag	<b>U1884S</b>	B6.5	<b>U1884D</b>	B6.7
Package1: Adult(x2) Small adult(x1) Adult long(x1) Large adult(x1) Large adult long(x1)		Variety		<b>U1801S-06</b> U1880S x 2 U1885S x 1 U1886S x 1 U1869S x 1 U1889S x 1	C8.9	<b>U1801D-06</b> U1880D x 2 U1885D x 1 U1886D x 1 U1869D x 1 U1889D x 1	D2
Package2: Adult(x1) Small adult(x1) Pediatric(x1) Adult long(x1) Large adult(x1) Thigh(x1)		Variety		<b>U1802S-06</b> U1880S x 1 U1885S x 1 U1881S x 1 U1886S x 1 U1869S x 1 U1884S x 1	D1.3	<b>U1802D-06</b> U1880D x 1 U1885D x 1 U1881D x 1 U1886D x 1 U1869D x 1 U1884D x 1	D3

## 1.2b Single Tube Cuff with Connector

Patient Size	Limb Circumference	REF#	Cuff Connector	Tubing Color	Package	Price(unit)
Large adult long	33-47cm	<b>U1889S-C12</b>	For Philips Siemens Spacelabs Mindray EDAN Comen Biolight ..... 	Signal violet	1 pc/bag	B5
Large adult	33-47cm	<b>U1869S-C12</b>		Signal violet	1 pc/bag	B4.1
Adult long	25-35cm	<b>U1886S-C12</b>		Dusty grey	1 pc/bag	B3
Adult	25-35cm	<b>U1880S-C12</b>		Dusty grey	1 pc/bag	B2
Small adult	20-28cm	<b>U1885S-C12</b>		Sky blue	1 pc/bag	B1
Pediatric	18-26cm	<b>U1881S-C12</b>		Green	1 pc/bag	B1
Infant	10-19cm	<b>U1882S-C12</b>		Red	1 pc/bag	A8
Neonate	6-11cm	<b>U1883S-C12</b>		Light blue	1 pc/bag	A8
Thigh	46-66cm	<b>U1884S-C12</b>		Brown	1 pc/bag	B6.6
Large adult long	33-47cm	<b>U1889S-C03</b>		For Colin Spacelabs Datascope ..... 	Signal violet	1 pc/bag
Large adult	33-47cm	<b>U1869S-C03</b>	Signal violet		1 pc/bag	B4.1
Adult long	25-35cm	<b>U1886S-C03</b>	Dusty grey		1 pc/bag	B3
Adult	25-35cm	<b>U1880S-C03</b>	Dusty grey		1 pc/bag	B2
Small adult	20-28cm	<b>U1885S-C03</b>	Sky blue		1 pc/bag	B1
Pediatric	18-26cm	<b>U1881S-C03</b>	Green		1 pc/bag	B1
Infant	10-19cm	<b>U1882S-C03</b>	Red		1 pc/bag	A8
Neonate	6-11cm	<b>U1883S-C03</b>	Light blue		1 pc/bag	A8
Thigh	46-66cm	<b>U1884S-C03</b>	Brown		1 pc/bag	B6.6
Large adult long	33-47cm	<b>U1889S-C18</b>	For Welch Allyn Protocol 		Signal violet	1 pc/bag
Large adult	33-47cm	<b>U1869S-C18</b>		Signal violet	1 pc/bag	B4.1
Adult long	25-35cm	<b>U1886S-C18</b>		Dusty grey	1 pc/bag	B3
Adult	25-35cm	<b>U1880S-C18</b>		Dusty grey	1 pc/bag	B2
Small adult	20-28cm	<b>U1885S-C18</b>		Sky blue	1 pc/bag	B1
Pediatric	18-26cm	<b>U1881S-C18</b>		Green	1 pc/bag	B1
Infant	10-19cm	<b>U1882S-C18</b>		Red	1 pc/bag	A8
Neonate	6-11cm	<b>U1883S-C18</b>		Light blue	1 pc/bag	A8
Thigh	46-66cm	<b>U1884S-C18</b>		Brown	1 pc/bag	B6.6
Large adult long	33-47cm	<b>U1889S-C58</b>		For Drager 	Signal violet	1 pc/bag
Large adult	33-47cm	<b>U1869S-C58</b>	Signal violet		1 pc/bag	B7.9
Adult long	25-35cm	<b>U1886S-C58</b>	Dusty grey		1 pc/bag	B6.7
Adult	25-35cm	<b>U1880S-C58</b>	Dusty grey		1 pc/bag	B6.6
Small adult	20-28cm	<b>U1885S-C58</b>	Sky blue		1 pc/bag	B6.5
Pediatric	18-26cm	<b>U1881S-C58</b>	Green		1 pc/bag	B6.5
Infant	10-19cm	<b>U1882S-C58</b>	Red		1 pc/bag	B6
Neonate	6-11cm	<b>U1883S-C58</b>	Light blue		1 pc/bag	B6
Thigh	46-66cm	<b>U1884S-C58</b>	Brown		1 pc/bag	C1.4
Package 1:		<b>U1801S-C12-06</b> U1880S-C12 X2 U1885S-C12 X1 U1886S-C12 X1 U1869S-C12 X1 U1889S-C12 X1			Variety	Total 6 pcs
Package 1:		<b>U1801S-C03-06</b> U1880S-C03 X2 U1885S-C03 X1 U1886S-C03 X1 U1869S-C03 X1 U1889S-C03 X1		Variety	Total 6 pcs	D1.5
Package 1:		<b>U1801S-C18-06</b> U1880S-C18 X2 U1885S-C18 X1 U1886S-C18 X1 U1869S-C18 X1 U1889S-C18 X1		Variety	Total 6 pcs	D1.5

Patient Size	Limb Circumference	REF#	Cuff Connector	Tubing Color	Package	Price(unit)
Package 2: Adult(1) Small adult (1) Pediatric(1) Adult long(1) Large adult(1)	33-47cm	U1802S-C12-06 U1880S-C12 X1 U1885S-C12 X1 U1881S-C12 X1 U1886S-C12 X1 U1869S-C12 X1 U1884S-C12 X1		Variety	Total 6 pcs	D3
		U1802S-C03-06 U1880S-C03 X1 U1885S-C03 X1 U1881S-C03 X1 U1886S-C03 X1 U1869S-C03 X1 U1884S-C03 X1		Variety	Total 6 pcs	D3
		U1802S-C18-06 U1880S-C18 X1 U1885S-C18 X1 U1881S-C18 X1 U1886S-C18 X1 U1869S-C18 X1 U1884S-C18 X1		Variety	Total 6 pcs	D3

1.2c Double Tubes cuff with connector

Patient Size	Limb Circumference	REF#	Cuff End Connector	Tubing Color	Package	Price(unit)
Large adult long	33-47cm	U1889D-C0808	For GE Corometrics GE Dianmap ..... 	Signal violet	1 pc/bag	B6
Large adult	33-47cm	U1869D-C0808		Signal violet	1 pc/bag	B5.3
Adult long	25-35cm	U1886D-C0808		Dusty grey	1 pc/bag	B4
Adult	25-35cm	U1880D-C0808		Dusty grey	1 pc/bag	B3
Small adult	20-28cm	U1885D-C0808		Sky blue	1 pc/bag	B2
Pediatric	18-26cm	U1881D-C0808		Green	1 pc/bag	B2
Infant	10-19cm	U1882D-C0808		Red	1 pc/bag	B1
Neonate	6-11cm	U1883D-C0808	Light blue	1 pc/bag	B1	
Thigh	46-66cm	U1884D-C0808	Brown	1 pc/bag	B7	
Large adult long	33-47cm	U1889D-C1818	For GE Eagle/Dash/Tram/Solar ..... 	Signal violet	1 pc/bag	B6.5
Large adult	33-47cm	U1869D-C1818		Signal violet	1 pc/bag	B6
Adult long	25-35cm	U1886D-C1818		Dusty grey	1 pc/bag	B4.1
Adult	25-35cm	U1880D-C1818		Dusty grey	1 pc/bag	B4
Small adult	20-28cm	U1885D-C1818		Sky blue	1 pc/bag	B3
Pediatric	18-26cm	U1881D-C1818		Green	1 pc/bag	B3
Infant	10-19cm	U1882D-C1818		Red	1 pc/bag	B2
Neonate	6-11cm	U1883D-C1818	Light blue	1 pc/bag	B2	
Thigh	46-66cm	U1884D-C1818	Brown	1 pc/bag	B7.9	
Large adult long	33-47cm	U1889D-C1718	For GE Datex Ohmeda 	Signal violet	1 pc/bag	B6.5
Large adult	33-47cm	U1869D-C1718		Signal violet	1 pc/bag	B6
Adult long	25-35cm	U1886D-C1718		Dusty grey	1 pc/bag	B4.1
Adult	25-35cm	U1880D-C1718		Dusty grey	1 pc/bag	B4
Small adult	20-28cm	U1885D-C1718		Sky blue	1 pc/bag	B3
Pediatric	18-26cm	U1881D-C1718		Green	1 pc/bag	B3
Infant	10-19cm	U1882D-C1718		Red	1 pc/bag	B2
Neonate	6-11cm	U1883D-C1718	Light blue	1 pc/bag	B2	
Thigh	46-66cm	U1884D-C1718	Brown	1 pc/bag	B7.9	

Patient Size	Limb Circumference	REF#	Cuff End Connector	Tubing Color	Package	Price(unit)
Large adult long	33-47cm	U1889D-C5858	For Drager 	Signal violet	1 pc/bag	C5
Large adult	33-47cm	U1869D-C5858		Signal violet	1 pc/bag	C4
Adult long	25-35cm	U1886D-C5858		Dusty grey	1 pc/bag	C3.8
Adult	25-35cm	U1880D-C5858		Dusty grey	1 pc/bag	C3
Small adult	20-28cm	U1885D-C5858		Sky blue	1 pc/bag	C2
Pediatric	18-26cm	U1881D-C5858		Green	1 pc/bag	C2
Infant	10-19cm	U1882D-C5858		Red	1 pc/bag	C1.4
Neonate	6-11cm	U1883D-C5858		Light blue	1 pc/bag	C1.4
Thigh	46-66cm	U1884D-C5858		Brown	1 pc/bag	C6
Package1: Adult(x2) Small adult(x1) Adult long(x1) Large adult(x1) Large adult long(x1)	33-47cm	U1801D-C0808-06 U1880D-C0808 X2 U1885D-C0808 X1 U1886D-C0808 X1 U1869D-C0808 X1 U1889D-C0808 X1		Variety	Total 6 pcs	D3.4
		U1801D-C1818-06 U1880D-C1818 X2 U1885D-C1818 X1 U1886D-C1818 X1 U1869D-C1818 X1 U1889D-C1818 X1		Variety	Total 6 pcs	D3.9
		U1801D-C1718-06 U1880D-C1718 X2 U1885D-C1718 X1 U1886D-C1718 X1 U1869D-C1718 X1 U1889D-C1718 X1		Variety	Total 6 pcs	D3.9
Package2: Adult(x1) Small adult(x1) Pediatric(x1) Adult long(x1) Large adult(x1) Thigh(x1)	33-47cm	U1802D-C0808-06 U1880ND-C0808 X1 U1885ND-C0808 X1 U1881ND-C0808 X1 U1886ND-C0808 X1 U1869ND-C0808 X1 U1884ND-C0808 X1		Variety	Total 6 pcs	D3.8
		U1802D-C1818-06 U1880D-C1818 X1 U1885D-C1818 X1 U1881D-C1818 X1 U1886D-C1818 X1 U1869D-C1818 X1 U1884D-C1818 X1		Variety	Total 6 pcs	DD1.3
		U1802D-C1718-06 U1880D-C1718 X1 U1885D-C1718 X1 U1881D-C1718 X1 U1886D-C1718 X1 U1869D-C1718 X1 U1884D-C1718 X1		Variety	Total 6 pcs	DD1.3





## 2.1 Disposable Neonate NIBP Cuff

### 2.1a Disposable Neonate TPU Cuff

Size#	Limb Circumference	Printing Color	Package	REF# (Single Tube)	Cuff Connector	Price (Box)	REF # (Double Tubes)	Cuff Connector	Price (Box)
1	3-6cm	Orange	10pcs/box	U1681S-C05-10	For Philips/GE	C1	U1681D-C0505-10		C1.4
2	4-8cm	Purple red	10pcs/box	U1682S-C05-10		C1.4	U1682D-C0505-10		C3
3	6-11cm	Green	10pcs/box	U1683S-C05-10		C3	U1683D-C0505-10		C3.8
4	7-13cm	Gentian blue	10pcs/box	U1684S-C05-10		C3.8	U1684D-C0505-10		C4
5	8-15cm	Brown	10pcs/box	U1685S-C05-10		C4	U1685D-C0505-10		C5
1	3-6cm	Orange	10pcs/box	U1681S-C12-10	For Philips	C1	U1681D-C1212-10		C1.4
2	4-8cm	Purple red	10pcs/box	U1682S-C12-10		C1.4	U1682D-C1212-10		C3
3	6-11cm	Green	10pcs/box	U1683S-C12-10		C3	U1683D-C1212-10		C3.8
4	7-13cm	Gentian blue	10pcs/box	U1684S-C12-10		C3.8	U1684D-C1212-10		C4
5	8-15cm	Brown	10pcs/box	U1685S-C12-10		C4	U1685D-C1212-10		C5
1	3-6cm	Orange	10pcs/box	U1681S-C55-10	For Philips	C4	U1681D-C5555-10		C8.2
2	4-8cm	Purple red	10pcs/box	U1682S-C55-10		C5	U1682D-C5555-10		C8.3
3	6-11cm	Green	10pcs/box	U1683S-C55-10		C6	U1683D-C5555-10		C8
4	7-13cm	Gentian blue	10pcs/box	U1684S-C55-10		C6	U1684D-C5555-10		C8.6
5	8-15cm	Brown	10pcs/box	U1685S-C55-10		C6.7	U1685D-C5555-10		C8.9
1	3-6cm	Orange	10pcs/box	U1681S-C51-10	For GE	C1	U1681D-C5151-10	For GE	C1.4
2	4-8cm	Purple red	10pcs/box	U1682S-C51-10		C1.4	U1682D-C5151-10		C3
3	6-11cm	Green	10pcs/box	U1683S-C51-10		C3	U1683D-C5151-10		C3.8
4	7-13cm	Gentian blue	10pcs/box	U1684S-C51-10		C3.8	U1684D-C5151-10		C4
5	8-15cm	Brown	10pcs/box	U1685S-C51-10		C4	U1685D-C5151-10		C5

## 2 Disposable NIBP Cuff

### Specification

- Non-woven or TPU material for maximum patient comfort
- Single & double tube cuff with 50 cm length hose (Neonate cuff with 20cm hose)
- Cuffs with particular connectors to fit major brands monitoring systems
- Large selection of 13 sizes cuffs matching the different sizes patients
- Printings in particular color indicate the cuff sizes.
- Latex free



2.1b Disposable Neonate Soft Fiber Cuff



Size#	Limb Circumference	Printing Color	Package	REF# (Single Tube)	Cuff Connector	Price (Box)	REF # (Double Tubes)	Cuff Connector	Price (Box)
1	3-6cm	Orange	10pcs/box	U1781S-C05-10	For Philips/GE	B8	U1781D-C0505-10		C1
2	4-8cm	Purple red	10pcs/box	U1782S-C05-10		B8	U1782D-C0505-10		C1.3
3	6-11cm	Green	10pcs/box	U1783S-C05-10		C1	U1783D-C0505-10		C1.4
4	7-13cm	Gentian blue	10pcs/box	U1784S-C05-10		C1.3	U1784D-C0505-10		C3
5	8-15cm	Brown	10pcs/box	U1785S-C05-10		C1.4	U1785D-C0505-10		C3.8
1	3-6cm	Orange	10pcs/box	U1781S-C12-10	For Spacelabs Philips	B8	U1781D-C1212-10		C1
2	4-8cm	Purple red	10pcs/box	U1782S-C12-10		B8	U1782D-C1212-10		C1.3
3	6-11cm	Green	10pcs/box	U1783S-C12-10		C1	U1783D-C1212-10		C1.4
4	7-13cm	Gentian blue	10pcs/box	U1784S-C12-10		C1.3	U1784D-C1212-10		C3
5	8-15cm	Brown	10pcs/box	U1785S-C12-10		C1.4	U1785D-C1212-10		C3.8
1	3-6cm	Orange	10pcs/box	U1781S-C55-10	For Philips NEW	C3.8	U1781D-C5555-10		C8.1
2	4-8cm	Purple red	10pcs/box	U1782S-C55-10		C4	U1782D-C5555-10		C8.1
3	6-11cm	Green	10pcs/box	U1783S-C55-10		C5	U1783D-C5555-10		C8.3
4	7-13cm	Gentian blue	10pcs/box	U1784S-C55-10		C5	U1784D-C5555-10		C8
5	8-15cm	Brown	10pcs/box	U1785S-C55-10		C6	U1785D-C5555-10		C8.6
1	3-6cm	Orange	10pcs/box	U1781S-C51-10	For GE NEW	B8	U1781D-C5151-10		C1
2	4-8cm	Purple red	10pcs/box	U1782S-C51-10		B8	U1782D-C5151-10		C1.3
3	6-11cm	Green	10pcs/box	U1783S-C51-10		C1	U1783D-C5151-10		C1.4
4	7-13cm	Gentian blue	10pcs/box	U1784S-C51-10		C1.3	U1784D-C5151-10		C3
5	8-15cm	Brown	10pcs/box	U1785S-C51-10		C1.4	U1785D-C5151-10		C3.8

2.2 Disposable NIBP Cuff















2.2a Disposable NIBP TPU Cuff

Patient Size	Limb Circumference	Printing Color	Package	REF# (Single Tube)	REF# Single Tube	Price (Box)	REF # (Double Tubes)	Cuff Connector	Price (Box)		
Large adult long	35.5-46cm	Purple red	5pcs/box	U1610S-C12-05	For Philips Siemens Spacelabs .....	C6.7	U1610D-C0808-05		C8.1		
Large adult	35.5-46cm	Purple red	5pcs/box	U1620S-C12-05		C5	U1620D-C0808-05		GE Corometrics	C6	
Adult long	27.5-36.5cm	Gentian blue	5pcs/box	U1630S-C12-05		C4	U1630D-C0808-05		GE Dianmap	C5	
Adult	27.5-36.5cm	Gentian blue	5pcs/box	U1640S-C12-05		C1.4	U1640D-C0808-05		.....	C3.8	
Small adult	20.5-28.5cm	Sky blue	5pcs/box	U1650S-C12-05		<b>B8.1</b>	U1650D-C0808-05		.....	C1.4	
Pediatric	13.8-21.5cm	Green	5pcs/box	U1660S-C12-05		B7.9	U1660D-C0808-05		C1		
Infant	9-14.8cm	Orange	5pcs/box	U1670S-C12-05		B6.7	U1670D-C0808-05		B8		
Thigh	45-56cm	Brown	5pcs/box	U1690S-C12-05		C8.9	U1690D-C0808-05		D1.3		
Large adult long	35.5-46cm	Purple red	5pcs/box	U1610S-C55-05		For Philips .....	C8		U1610D-C48-05	For GE .....	C8.1
Large adult	35.5-46cm	Purple red	5pcs/box	U1620S-C55-05			C8.1		U1620D-C48-05		.....
Adult long	27.5-36.5cm	Gentian blue	5pcs/box	U1630S-C55-05	C6.7		U1630D-C48-05	.....	C5		
Adult	27.5-36.5cm	Gentian blue	5pcs/box	U1640S-C55-05	C5		U1640D-C48-05		C3.8		
Small adult	20.5-28.5cm	Sky blue	5pcs/box	U1650S-C55-05	C3.8		U1650D-C48-05		C1.4		
Pediatric	13.8-21.5cm	Green	5pcs/box	U1660S-C55-05		C3	U1660D-C48-05		C1		
Infant	9-14.8cm	Orange	5pcs/box	U1670S-C55-05		C1.4	U1670D-C48-05		B8		
Thigh	45-56cm	Brown	5pcs/box	U1690S-C55-05		D1.6	U1690D-C48-05		D1.3		
Large adult long	35.5-46cm	Purple red	5pcs/box	U1610S-C03-05		for Colin Spacelabs Datascope .....	C6.7		U1610D-C1818-05	For GE Datex ohmeda .....	C8.1
Large adult	35.5-46cm	Purple red	5pcs/box	U1620S-C03-05			C5		U1620D-C1818-05		GE Datex
Adult long	27.5-36.5cm	Gentian blue	5pcs/box	U1630S-C03-05	C4		U1630D-C1818-05	ohmeda	C5		
Adult	27.5-36.5cm	Gentian blue	5pcs/box	U1640S-C03-05	C1.4		U1640D-C1818-05	.....	C3.8		
Small adult	20.5-28.5cm	Sky blue	5pcs/box	U1650S-C03-05	<b>B8.1</b>		U1650D-C1818-05	.....	C1.4		
Pediatric	13.8-21.5cm	Green	5pcs/box	U1660S-C03-05		B7.9	U1660D-C1818-05		C1		
Infant	9-14.8cm	Orange	5pcs/box	U1670S-C03-05		B6.7	U1670D-C1818-05		<b>B8.1</b>		
Thigh	45-56cm	Brown	5pcs/box	U1690S-C03-05		C8.9	U1690D-C1818-05		D1.3		
Large adult long	35.5-46cm	Purple red	5pcs/box	U1610S-C18-05		For Welch Allyn Protocol	C8.1		U1610D-C1718-05	For GE Eagle/Dash/ Tram/Solar .....	C8.1
Large adult	35.5-46cm	Purple red	5pcs/box	U1620S-C18-05			C6		U1620D-C1718-05		.....
Adult long	27.5-36.5cm	Gentian blue	5pcs/box	U1630S-C18-05	C5		U1630D-C1718-05	.....	C5		
Adult	27.5-36.5cm	Gentian blue	5pcs/box	U1640S-C18-05	C3		U1640D-C1718-05	.....	C3.8		
Small adult	20.5-28.5cm	Sky blue	5pcs/box	U1650S-C18-05	C1		U1650D-C1718-05		C1.4		
Pediatric	13.8-21.5cm	Green	5pcs/box	U1660S-C18-05		<b>B8.1</b>	U1660D-C1718-05		C1		
Infant	9-14.8cm	Orange	5pcs/box	U1670S-C18-05		B7.9	U1670D-C1718-05		<b>B8.1</b>		
Thigh	45-56cm	Brown	5pcs/box	U1690S-C18-05		D1.3	U1690D-C1718-05		D1.3		



2.2b Disposable Soft Fiber Cuff



Patient Size	Limb Circumference	Printing Color	Package	REF# (Single Tube)	Cuff Connector	Price (Box)	REF # (Double Tubes)	Cuff Connector	Price (Box)
Large adult long	35.5-46cm	Purple red	5pcs/box	U1710S-C12-05	For Philips	C6	U1710D-C0808-05	For GE Corometrics	C6.7
Large adult	35.5-46cm	Purple red	5pcs/box	U1720S-C12-05	Siemens	C4	U1720D-C0808-05	GE Dianmap	C5
Adult long	27.5-36.5cm	Gentian blue	5pcs/box	U1730S-C12-05	Spacelabs	C3.8	U1730D-C0808-05	.....	C5
Adult	27.5-36.5cm	Gentian blue	5pcs/box	U1740S-C12-05	.....	C1.3	U1740D-C0808-05	.....	C3
Small adult	20.5-28.5cm	Sky blue	5pcs/box	U1750S-C12-05		B8	U1750D-C0808-05		C1.3
Child	13.8-21.5cm	Green	5pcs/box	U1760S-C12-05		B7	U1760D-C0808-05		<b>B8.1</b>
Infant	9-14.8cm	Orange	5pcs/box	U1770S-C12-05		B6.6	U1770D-C0808-05		<b>B7.9</b>
Thigh	45-56cm	Brown	5pcs/box	U1790S-C12-05		C8	U1790D-C0808-05		C8.9
Large adult long	35.5-46cm	Purple red	5pcs/box	U1710S-C55-05	For Philips	C8.1	U1710D-C48-05	For GE	C6.7
Large adult	35.5-46cm	Purple red	5pcs/box	U1720S-C55-05	.....	C7	U1720D-C48-05	.....	C5
Adult long	27.5-36.5cm	Gentian blue	5pcs/box	U1730S-C55-05		C6	U1730D-C48-05		C5
Adult	27.5-36.5cm	Gentian blue	5pcs/box	U1740S-C55-05		C4	U1740D-C48-05		C3
Small adult	20.5-28.5cm	Sky blue	5pcs/box	U1750S-C55-05		C3	U1750D-C48-05		C1.3
Child	13.8-21.5cm	Green	5pcs/box	U1760S-C55-05		C1.4	U1760D-C48-05		<b>B8.1</b>
Infant	9-14.8cm	Orange	5pcs/box	U1770S-C55-05		C1	U1770D-C48-05		<b>B7.9</b>
Thigh	45-56cm	Brown	5pcs/box	U1790S-C55-05		D1.3	U1790D-C48-05		C8.9
Large adult long	35.5-46cm	Purple red	5pcs/box	U1710S-C03-05	For Colin	C6	U1710D-C1818-05	For GE Datex	C6.7
Large adult	35.5-46cm	Purple red	5pcs/box	U1720S-C03-05	Spacelabs	C4	U1720D-C1818-05	ohmeda	C5
Adult long	27.5-36.5cm	Gentian blue	5pcs/box	U1730S-C03-05	Datascope	C3.8	U1730D-C1818-05	.....	C5
Adult	27.5-36.5cm	Gentian blue	5pcs/box	U1740S-C03-05	.....	C1.3	U1740D-C1818-05	.....	C3
Small adult	20.5-28.5cm	Sky blue	5pcs/box	U1750S-C03-05		B8	U1750D-C1818-05		C1.3
Child	13.8-21.5cm	Green	5pcs/box	U1760S-C03-05		B7	U1760D-C1818-05		<b>B8.1</b>
Infant	9-14.8cm	Orange	5pcs/box	U1770S-C03-05		B6.6	U1770D-C1818-05		B8
Thigh	45-56cm	Brown	5pcs/box	U1790S-C03-05		C8	U1790D-C1818-05		C8.9
Large adult long	35.5-46cm	Purple red	5pcs/box	U1710S-C18-05	For Welch Allyn	C7	U1710D-C1718-05	For GE Eagle/Dash/Tram/Solar	C6.7
Large adult	35.5-46cm	Purple red	5pcs/box	U1720S-C18-05	Protocol	C5	U1720D-C1718-05	.....	C5
Adult long	27.5-36.5cm	Gentian blue	5pcs/box	U1730S-C18-05		C4	U1730D-C1718-05		C5
Adult	27.5-36.5cm	Gentian blue	5pcs/box	U1740S-C18-05		C1.4	U1740D-C1718-05		C3
Small adult	20.5-28.5cm	Sky blue	5pcs/box	U1750S-C18-05		B8	U1750D-C1718-05		C1.3
Child	13.8-21.5cm	Green	5pcs/box	U1760S-C18-05		B8	U1760D-C1718-05		<b>B8.1</b>
Infant	9-14.8cm	Orange	5pcs/box	U1770S-C18-05		B7	U1770D-C1718-05		B8
Thigh	45-56cm	Brown	5pcs/box	U1790S-C18-05		C8.9	U1790D-C1718-05		C8.9



3 Patient NIBP Adapter Air Hose





OEM Manufacturer & Models	Patient Size	Plug to Monitor	Plug to Cuff	Hose Length	Unimed REF#	Original REF#	Package	Price (Unit)	
<b>Philips</b> All other Philips monitors	Adult Pediatric			1.5m	<b>HS15-16-15</b>	M1598A/M1598B	1 pc/bag	B6	
				2.5m	<b>HS-16-15</b>		1 pc/bag	B6.5	
				3.0m	<b>HS30-16-15</b>	M1599A/M1599B	1 pc/bag	B6.6	
	Infant Neonate			1.5m	<b>HSN15-16-20</b>	M1596A/M1596B	1 pc/bag	B4.1	
				2.5m	<b>HSN-16-20</b>		1 pc/bag	B5.3	
				3.0m	<b>HSN30-16-20</b>	M1597B	1 pc/bag	B6	
	Infant Neonate			1.5m	<b>HSN15-16-56</b>	M1596C	1 pc/bag	B4	
				2.5m	<b>HSN-16-56</b>		1 pc/bag	B4.1	
				3.0m	<b>HSN30-16-56</b>	M1597C	1 pc/bag	B5	
<b>Philips A1/A3/C1/AS3 Spacelabs/Siemens Mindray</b> ..... (with bayonet-style connector)	Adult Pediatric			2.5m	<b>HS-15-15</b>		1 pc/bag	B6.7	
				3.0m	<b>HS30-15-15</b>	M3918A/989803136931	1 pc/bag	B7	
	Infant Neonate			2.5m	<b>HSN-15-20</b>		1 pc/bag	B6.5	
				3.0m	<b>HSN30-15-20</b>	989803136941	1 pc/bag	B6.6	
	<b>GE-Dinamap</b> DINAMAP Pro Series, DINAMAP ProCare, CARESCAPE V100/VC150, Compact, MPS Series Monitors .....	Adult Pediatric			2.5m	<b>HD-25-09</b>		1 pc/bag	B6.7
					3.6m	<b>HD36-25-09</b>	107365	1 pc/bag	B7.9
7.2m					<b>HD72-25-09</b>	107366	1 pc/bag	C3.8	
Adult Pediatric				2.5m	<b>HD-25-17</b>		1 pc/bag	B6.5	
				3.6m	<b>HD36-25-17</b>	107363	1 pc/bag	B6.7	
Adult Pediatric				2.5m	<b>HD-25-47</b>		1 pc/bag	B6.7	
				3.6m	<b>HD36-25-47</b>		1 pc/bag	B7.9	
				7.2m	<b>HD72-25-47</b>		1 pc/bag	C3.8	
Adult Pediatric				2.5m	<b>HD-25-69</b>		1 pc/bag	B8	
				3.6m	<b>HD36-25-69</b>	2058205-001	1 pc/bag	C1.3	
				7.2m	<b>HD72-25-69</b>	2058205-002	1 pc/bag	C5	
Infant Neonate				2.5m	<b>HDN-25-27</b>		1 pc/bag	B6	
				3.6m	<b>HDN36-25-27</b>	107368	1 pc/bag	B6.6	
Infant Neonate				2.5m	<b>HDN-25-52</b>		1 pc/bag	B6.6	
				3.6m	<b>HDN36-25-52</b>	2058206-001	1 pc/bag	B7	
<b>GE-Dinamap</b> 1846, 8100, 9300 and Plus Series Monitors	Adult Pediatric			2.5m	<b>HD-09-09</b>		1 pc/bag	B6.7	
				3.6m	<b>HD36-09-09</b>	008841	1 pc/bag	B8	
				7.2m	<b>HD72-09-09</b>	008842	1 pc/bag	C3.8	
	Adult Pediatric			2.5m	<b>HD-09-17</b>		1 pc/bag	B6.6	
				3.6m	<b>HD36-09-17</b>	088845	1 pc/bag	B7.9	
	Infant Neonate			2.5m	<b>HDN-09-27</b>		1 pc/bag	B6.5	
3.6m				<b>HDN36-09-27</b>	008840	1 pc/bag	B7		
<b>GE-Datex Ohmeda</b> AS/3, CS/3, Cardiocap II, Cardiocap/5, Light, S/5 <b>GE-Marquette</b> Eagle 4000, Tram 100/200/250/300/350	Adult Pediatric			1.8m	<b>HD18-22-17/18</b>	895732	1 pc/bag	B5.3	
				2.5m	<b>HD-22-17/18</b>	877235	1 pc/bag	B6.5	
				3.0m	<b>HD30-22-17/18</b>	879739	1 pc/bag	B6.6	
				6.0m	<b>HD60-22-17/18</b>		1 pc/bag	C1.4	
	Adult Pediatric			2.5m	<b>HD-22-17</b>		1 pc/bag	B6	
				3.6m	<b>HD36-22-17</b>	9461-203	1 pc/bag	B6.7	
	Adult Pediatric			2.5m	<b>HD-22-09</b>		1 pc/bag	B6.7	
				3.6m	<b>HD36-22-09</b>	9461-214	1 pc/bag	B8	
	Infant Neonate			2.5m	<b>HDN-22-27</b>	9461-205	1 pc/bag	B6	
3.0m				<b>HDN30-22-27</b>	877514	1 pc/bag	B6.5		
3.6m				<b>HDN36-22-27</b>	9461-215	1 pc/bag	B6.6		

OEM Manufacturer & Models	Patient Size	Plug to Monitor	Plug to Cuff	Hose Length	Unimed REF#	Original REF#	Package	Price (Unit)
<b>GE-Marquette</b> Dash 2000/2500/3000/4000/5000, Eagle 3000, PDM Module, Procare B40, SOLAR, Tram 400/450/451/800/850/851 <b>GE-Corometrics</b> 120, 128, 129, 250, 259, 259cx <b>GE-Dinamap</b> Carescape B450/B650/B850	Adult Pediatric			1.2m	<b>HD12-24-17</b>	2017008-002	1 pc/bag	B5
				2.5m	<b>HD-24-17</b>		1 pc/bag	B6.5
				3.6m	<b>HD36-24-17</b>	2017008-001	1 pc/bag	B7
	Adult Pediatric			1.2m	<b>HD12-24-09</b>	2017008-004	1 pc/bag	B6
				2.5m	<b>HD-24-09</b>		1 pc/bag	B6.7
				3.6m	<b>HD36-24-09</b>	2017008-003	1 pc/bag	B8
	Adult Pediatric			1.2m	<b>HD12-24-47</b>		1 pc/bag	B6.5
				2.5m	<b>HD-24-47</b>		1 pc/bag	B6.7
				3.6m	<b>HD36-24-47</b>		1 pc/bag	B7.9
	Adult Pediatric			7.2m	<b>HD72-24-47</b>		1 pc/bag	C3.8
				2.5m	<b>HD-24-69</b>		1 pc/bag	B8
				3.6m	<b>HD36-24-69</b>	2058203-002	1 pc/bag	C1.3
	Infant Neonate			7.2m	<b>HD72-24-69</b>	2058203-003	1 pc/bag	C5
				1.2m	<b>HDN12-24-27</b>	2017009-002	1 pc/bag	B5
				2.5m	<b>HDN-24-27</b>	2017009-001	1 pc/bag	B6
Infant Neonate			3.6m	<b>HDN36-24-27</b>	2017009-003	1 pc/bag	B6.6	
			6.0m	<b>HDN60-24-27</b>	2017009-004	1 pc/bag	C1.3	
			2.5m	<b>HDN-24-20</b>		1 pc/bag	B7	
Infant Neonate			3.6m	<b>HDN36-24-20</b>	9461-216	1 pc/bag	B8.1	
			2.5m	<b>HDN-24-20-2</b>		1 pc/bag	B7.9	
			3.6m	<b>HDN36-24-20-2</b>	9461-218	1 pc/bag	C1	
Infant Neonate			2.5m	<b>HDN-24-52</b>	2058204-002	1 pc/bag	B6.6	
			3.6m	<b>HDN36-24-52</b>	2058204-003	1 pc/bag	B7	
			1.2m	<b>HD12-70-69</b>	2087389-001	1 pc/bag	B7.9	
<b>GE-Marquette</b> CARESCAPE ONE	Adult Pediatric			2.5m	<b>HD-70-69</b>		1 pc/bag	C1
				3.6m	<b>HD36-70-69</b>	2087389-002	1 pc/bag	C2
				6.0m	<b>HD60-70-69</b>	2087389-003	1 pc/bag	C5
<b>Nihon Kohden</b>	Adult Pediatric			1.5m	<b>HD15-30-18</b>	YN-900P/S901	1 pc/bag	B6.7
				2.5m	<b>HD-30-18</b>		1 pc/bag	B7.9
				3.5m	<b>HD35-30-18</b>	YN-901P/S902	1 pc/bag	B8
	Adult Pediatric			2.5m	<b>HD-64-18</b>		1 pc/bag	B6.7
				3.0m	<b>HD30-64-18</b>	YN-701S	1 pc/bag	B7
				1.5m	<b>HD15-37-18</b>	YN-100T	1 pc/bag	B6
	Adult Pediatric			2.5m	<b>HD-37-18</b>		1 pc/bag	B6.6
				3.0m	<b>HD30-37-18</b>		1 pc/bag	B6.7
				3.5m	<b>HD35-37-18</b>	YN-101T	1 pc/bag	B7
Infant Neonate			1.5m	<b>HDN15-30-20</b>	YN-920P/S904	1 pc/bag	B7.9	
			2.5m	<b>HDN-30-20</b>		1 pc/bag	C1	
			3.5m	<b>HDN35-30-20</b>	YN-921P/S905	1 pc/bag	C2	
<b>Criticare Datascope Spacelabs Welch Allyn</b> .....	Adult Pediatric			2.5m	<b>HS-04-07</b>		1 pc/bag	B6
	Infant Neonate			2.5m	<b>HSN-04-20</b>		1 pc/bag	B6
<b>Omron-Colin</b> .....	Adult Pediatric			2.5m	<b>HS-32-31</b>	A016ZZ/9968172-6	1 pc/bag	B6
				3.5m	<b>HS35-32-31</b>	A015ZZ/9968171-8	1 pc/bag	B6.5
	Infant Neonate			2.5m	<b>HSN-32-20</b>		1 pc/bag	B5.3
				3.5m	<b>HSN35-32-20</b>		1 pc/bag	B6.5

OEM Manufacturer & Models	Patient Size	Plug to Monitor	Plug to Cuff	Hose Length	Unimed REF#	Original REF#	Package	Price (Unit)
<b>Dräger/Siemens</b> Infinity Delta, Infinity Gamma, Infinity Kappa, Infinity Vista, SC 6000, SC 7000, SC 8000, SC 9000	Adult Pediatric			2.5m	<b>HS-40-15</b>		1 pc/bag	C1
				3.7m	<b>HS37-40-15</b>		1 pc/bag	C1.3
	Adult Pediatric			2.5m	<b>HS-40-57</b>		1 pc/bag	C5
				3.7m	<b>HS37-40-57</b>	MP00953	1 pc/bag	C6
	Infant Neonate			2.5m	<b>HSN-40-20</b>	2870298	1 pc/bag	B8
<b>Physio Control</b> Lifepak 20	Adult Pediatric			2.5m	<b>HS-12-15</b>		1 pc/bag	B5
	Infant Neonate			2.5m	<b>HSN-12-20</b>		1 pc/bag	B4
<b>Physio Control</b> Lifepak 12	Adult Pediatric			2.5m	<b>HTS-44-15</b>	21300-008148	1 pc/bag	C4
	Infant Neonate			2.5m	<b>HTS-44-20</b>	11996-000125	1 pc/bag	C3.8
<b>MEK</b> MP700, MP1000	Adult Pediatric			2.5m	<b>HS-09-09</b>		1 pc/bag	B3
	Infant Neonate			2.5m	<b>HSN-09-20</b>		1 pc/bag	B4.1
<b>Welch Allyn</b> Altas	Adult Pediatric			2.5m	<b>HS-04-09</b>		1 pc/bag	B4.1
	Adult Pediatric			2.5m	<b>HD-41-09</b>		1 pc/bag	B6.7
	Adult Pediatric			2.5m	<b>HS-42-43</b>		1 pc/bag	B3
	Infant Neonate			2.5m	<b>HDN-41-27</b>		1 pc/bag	B5.3
	Infant Neonate			2.5m	<b>HSN-04-20</b>		1 pc/bag	B6
<b>Infinium</b> Infitron II, Omni II, Omni III	Adult Pediatric			2.5m	<b>HS-36-2T</b>	P02112	1 pc/bag	B6
	Adult Pediatric			2.5m	<b>HS-36-15</b>		1 pc/bag	B7
<b>Mindray</b> T series, iPM Series, IMEC Series	Adult Pediatric			2.5m	<b>HS-61-15</b>	CM1903, 6200-30-09688, 115-012522-00	1 pc/bag	B6.7
	Infant Neonate			2.5m	<b>HSN-61-20</b>	1196-00125	1 pc/bag	B5.3

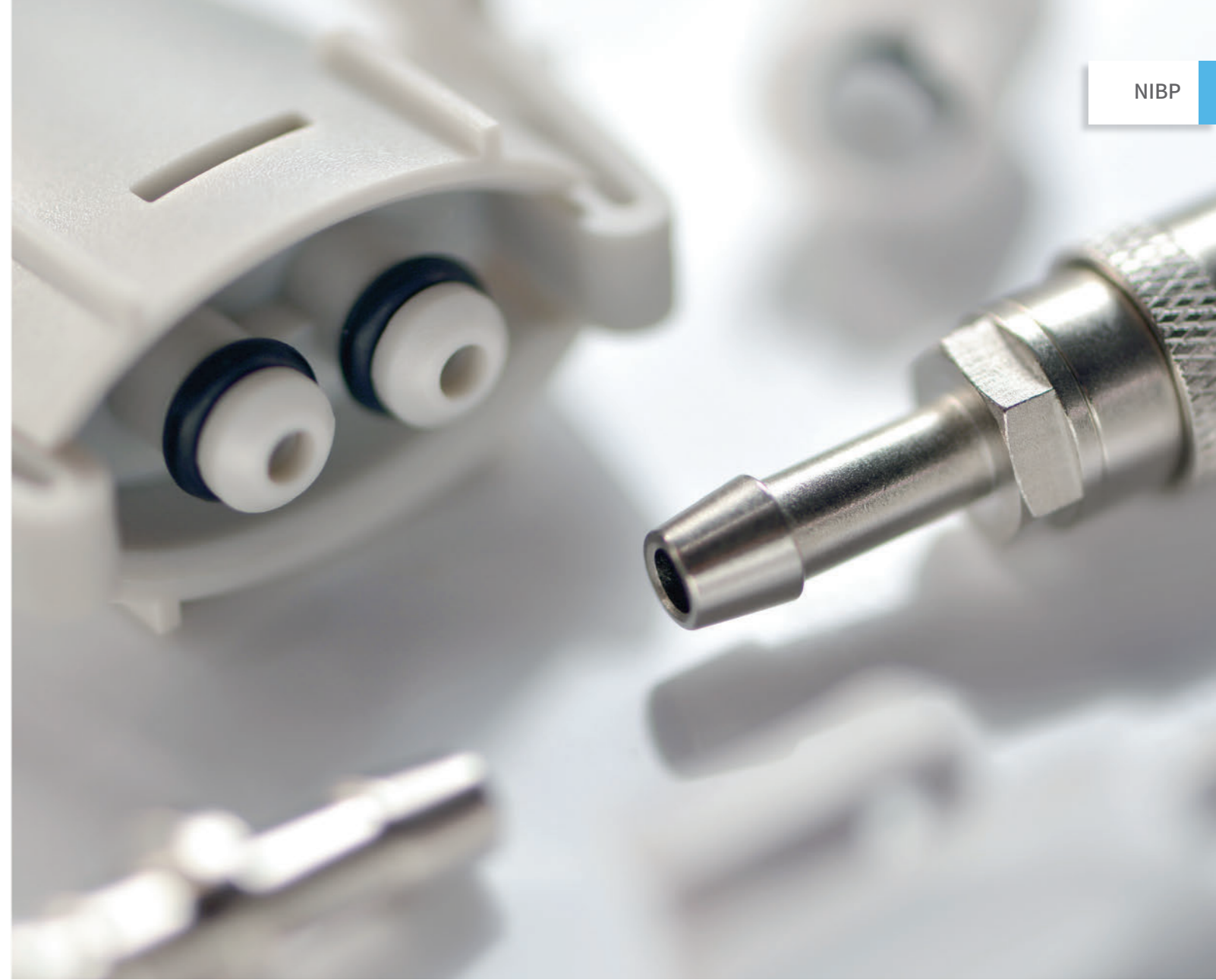

## 4 NIBP Connectors & Tubing

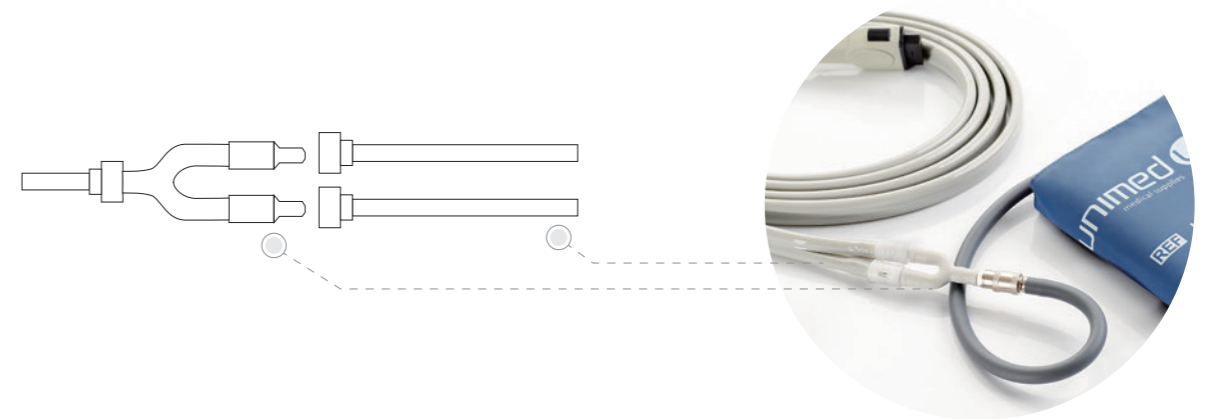



# 4.1 Universal Y Adapter



4.1a Single Tube Air Hose to Double Tube BP Cuff

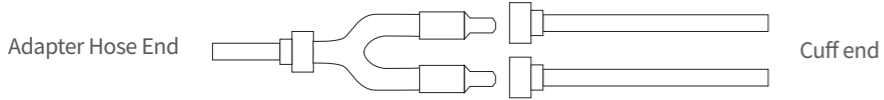

Package: poly-bag

REF#	BP3T-Y	BP3T-1718	BP3T-1717	BP3T-0909	BP3T-2T2T	BP3T-2020
Image						
Price (1pc)	A2	A5.5	A5.5	A7	A6	B1
REF#	BP12-3T	BP12-1718	BP12-1717	BP12-0909	BP12-2T2T	BP12-2020
Image						
Price (1pc)	A4	A6	A6	A8	A6	B3
REF#	BP18-3T	BP18-1718	BP18-1717	BP18-0909	BP18-2T2T	BP18-2020
Image						
Price (1pc)	A4	A6	A6	A8	A5.5	B3
REF#	BP04-3T	BP04-1718	BP04-1717	BP04-0909	BP04-2T2T	BP04-2020
Image						
Price (1pc)	A7	B2	B2	B3	B1	B5
REF#	BP08-3T	BP08-1718	BP08-1717	BP08-0909	BP08-2T2T	BP08-2020
Image						
Price (1pc)	A4	A6	A6	A8	A5.5	B3
REF#	BP2T-3T	BP2T-1718	BP2T-1717	BP2T-0909	BP2T-2T2T	BP2T-2020
Image						
Price (1pc)	A4	A6	A6	B1	A6	B4
REF#	BP21-3T	BP21-1718	BP21-1717	BP21-0909	BP21-2T2T	BP21-2020
Image						
Price (1pc)	A5	A6	A7	A8	A6	B3

4.1b Double Tube Air Hose to Single Tube BP Cuff

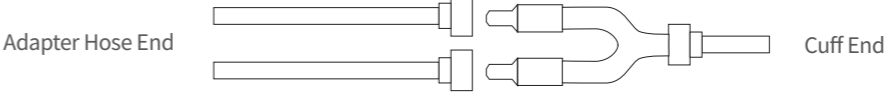

Package: poly-bag

REF#	BP3T-Y	BP15-3T	BP04-3T	BP18-3T	BP2T-3T	BP20-3T
Image						
Price (1pc)	A2	B2	A7	A4	A4	A8
REF#	BP3T-1718	BP15-1718	BP04-1718	BP18-1718	BP2T-1718	BP20-1718
Image						
Price (1pc)	A5.5	B5	B2	A6	A6	B2
REF#	BP3T-1818	BP15-1818	BP04-1818	BP18-1818	BP2T-1818	BP20-1818
Image						
Price (1pc)	A5.5	B3	B2	A6	A6	B1
REF#	BP3T-0808	BP15-0808	BP04-0808	BP18-0808	BP2T-0808	BP20-0808
Image						
Price (1pc)	A4	B3	A8	A5.5	A5.5	A8
REF#	BP3T-1212	BP15-1212	BP04-1212	BP18-1212	BP2T-1212	BP20-1212
Image						
Price (1pc)	A5.5	B3	B1	A6	A6	B1
REF#	BP3T-0505	BP15-0505	BP04-0505	BP18-0505	BP2T-0505	BP20-0505
Image						
Price (1pc)	B3	B6.5	B5.3	B4	B4	B5.3



## 4.2 Connectors for Cuff and Hose



























REF#	BP03		BP04		BP05	
Image						
Use with	BP06		BP07		BP20	
Compatibility	Bruker Mennen Schiller GE (300668) Welch Allyn (5082-168)		Datascope Nihon Kohden ..... Criticare Welch Allyn Fukuda Denshi		Bruker Draeger Physio Control Philips Schiller GE (300667) .....	
Price (unit)	A1		A6		A6	
REF#	BP05-P		BP06		BP07	
Image						
Use with	BP20		BP03		BP04	
Compatibility	Disposable Neonatal Cuff Welch Allyn (5082-176)		BCI Datascope Welch Allyn (5082-165)		Datascope Nihon Kohden Criticare Welch Allyn Fukuda Denshi Mediana .....	
Price (unit)	A1		A2		A7	
REF#	BP08		BP09		BP09-P	
Image						
Use with	BP09		BP08		BP08	
Compatibility	Invivo Mennen Nihon Kohden Welch Allyn (5082-164) GE (300664)		Invivo Kontron Nihon Kohden Welch Allyn (5082-161) GE (300619)		GE Invivo Kontron Nihon Kohden	
Price (unit)	A1		A3		A2	

REF#	BP12		BP12-P		BP15	
Image						
Use with	BP15		BP15		BP12/BP12-P	
Compatibility	Draeger GE (330059) Welch Allyn (5082-184) Mindray Philips		Criticare Draeger Physio control Mindray Philips Spacelabs .....		Schiller Philips GE (330060) Welch Allyn (5082-185) .....	
Price (unit)	A2		A1		A8	
REF#	BP16		BP17		BP18	
Image						
Use with	/		BP18		BP17	
Compatibility	Philips		GE (330091) Welch Allyn (5082-178) Nihon Kohden		GE (330064) Welch Allyn (5082-182) Zoll	
Price (unit)	A5		A2		A2	
REF#	BP20		BP21		BS21	
Image						
Use with	BP05/BP05-P		BS21		BP21	
Compatibility	for neonate disposable BP cuffs		Pace Tech		GE (330057) Welch Allyn (5082-181)	
Price (unit)	A5		A2		A7	
REF#	BP2T-M		BP22		BS22	
Image						
Use with	/		BS22		BP22	
Compatibility	GE-Datex Ohmeda GE-Marquette		GE-Datex Ohmeda GE-Marquette		GE-Datex Ohmeda GE-Marquette	
Price (unit)	A2		A5		A8	

REF#	BP24		BP25		BP26	
Image						
Use with	/		/		/	
Compatibility	GE-Marquette		GE(330073)		for neonate disposable BP cuffs	
Price (unit)	A5		A5		A3	
REF#	BP27		BP28		BP30	
Image						
Use with	/		/		/	
Compatibility	for neonate disposable BP cuffs		Connect with two double tube		Nihon Kohden (for neonate/infant)	
Price (unit)	A2		A3		A7	
REF#	BP30A		BP31		BP32	
Image						
Use with	/		BP32		BP31	
Compatibility	Nihon Kohden (for adult/pediatric)		Colin Gambro Tyco		Colin Gambro Tyco	
Price (unit)	A7		A7		A6	
REF#	BP34		BP35		BP36	
Image						
Use with	BP35		BP34		/	
Compatibility	Colin Gambro Tyco		Colin Gambro Tyco		Omni express	
Price (unit)	A8		A7		A7	





REF#	BP37		BP38		BP39	
Image						
Use with	/		BP39		BP38	
Compatibility	Nihon Kohden OPV-1500		Kendall		Kendall	
Price (unit)	A3		A5		A3	
REF#	BP40		BP41		BP42	
Image						
Use with	/		/		/	
Compatibility	Draeger/Siemens		Welch Allyn (Connex Spot, Spot Vital Signs Ixi)		Welch Allyn	
Price (unit)	B3		A3		A5	
REF#	BP43		BP44		BP45	
Image						
Use with	BP42		/		1-tube FlexiPort	
Compatibility	Welch Allyn		Medtronic- Physio Control		Welch Allyn (PORT-1)	
Price (unit)	A2		A6		A2	
REF#	BP46		BP47		BP48	
Image						
Use with	2-tube FlexiPort		BP48		BP47/BP69	
Compatibility	Welch Allyn (PORT-2)		GE-Dinamap		GE-Dianmap	
Price (unit)	A2		A6		A2	

REF#	BP49		BP3T-Y		BP51	
Image						
Use with	BP48		/		BP52/BP54	
Compatibility	GE-Dinamap		3Y Adapter GE-Dinamap(200829) Welch Allyn(5082-183)		GE Neo-Snap Connector	
Price (unit)	B3		A2		A1	
REF#	BP52		BP54		BP55	
Image						
Use with	BP51		BP51		BP56	
Compatibility	GE Neo-Snap Connector		GE		Philips(989803168821)	
Price (unit)	A3		A2		A3	
REF#	BP56		BP57		BP57A	
Image						
Use with	BP55		BP58		BP58	
Compatibility	Philips(989803167531)		Draeger(Connect with hose)		Draeger(MP00945)(Connect with BP15)	
Price (unit)	A3		B6.7		B6.7	
REF#	BP58		BP61		BP63	
Image						
Use with	BP57/BP57A		/		BP45/BP46	
Compatibility	Draeger		Mindray		Welch Allyn	
Price (unit)	B3		A6		A3	

REF#	BP64		BP68		BP69	
Image						
Use with	/		BP17		BP48	
Compatibility	Nihon Kohden		GE Suntech Corpuls		GE DINACLICK(2059294-001)	
Price (unit)	A3		A2		B1	
REF#	BP71		Reserved			
Image						
Use with	BP48					
Compatibility	GE DINACLICK(2055630-001)					
Price (unit)	B3					

### 4.3 Air Tubing



Image	REF#	Application	Inner Diameter	Color	Price (unit)
	Y02-H008	Adult/Pediatric single tube hose	φ3.50mm	Light gray	A2/m
	Y02-H007	Adult/Pediatric double tube hose	φ3.40mm	Light gray	A4/m
	Y02-H010	Neonate/Infant sing tube hose	φ3.00mm	Light blue	A3/m
	Y02-H009	Neonate/Infant double tube hose	φ3.40mm	Light blue	A4/m



## 5 Manual Inflation System



### 5.1 Reusable Cuff with Inflation System

See Figures A (Reusable Cuff, with Bulb&Valve)

Patient Size	Limb Circumference	REF#	Package	Price (box)
Large adult long	33-47cm	U1889ND-B01-05	5 pcs/box	D3.9
Large adult	33-47cm	U1869ND-B01-05	5 pcs/box	D3.4
Adult long	25-35cm	U1886ND-B01-05	5 pcs/box	D1.4
Adult	25-35cm	U1880ND-B01-05	5 pcs/box	C8.9
Small adult	20-28cm	U1885ND-B01-05	5 pcs/box	C8
Pediatric	18-26cm	U1881ND-B01-05	5 pcs/box	C8

### 5.2 Disposable Cuff with Inflation System

See Figures B (Disposable Cuff, with Bulb&Valve)

Patient Size	Limb Circumference	REF#	Package	Price (box)
Large adult long	33-47cm	U1710D-B02-05	5 pcs/box	C8.6
Large adult	33-47cm	U1720D-B02-05	5 pcs/box	C8
Adult long	25-35cm	U1730D-B02-05	5 pcs/box	C8.3
Adult	25-35cm	U1740D-B02-05	5 pcs/box	C6
Small adult	20-28cm	U1750D-B02-05	5 pcs/box	C5
Pediatric	18-26cm	U1760D-B02-05	5 pcs/box	C5

## 6 Wall Manometer Accessories



### 6.1 Inflation System with Reusable Cuff

(Coiled Tubing, Adapter with Screw Connectors, Bulb&Valve, and Double Tube Reusable Cuff)

Patient Size	Limb Circumference	REF#	Package	Price (box)
Adult	25-35cm(with clip)	U1880HD-CT-B01-05	5 pcs/box	D5.2.5
Large adult long	35.5-46cm	U1889ND-CT-B01-05	5 pcs/box	D5.1.9
Large adult	35.5-46cm	U1869ND-CT-B01-05	5 pcs/box	D5.1.4
Adult long	27.5-36.5cm	U1886ND-CT-B01-05	5 pcs/box	D5.09
Adult	27.5-36.5cm	U1880ND-CT-B01-05	5 pcs/box	D5
Small adult	20.5-28.5cm	U1885ND-CT-B01-05	5 pcs/box	DD2.4
Pediatric	13.8-21.5cm	U1881ND-CT-B01-05	5 pcs/box	DD2.4

## 6.2 Inflation System without Cuff (Coiled tubing, w/o connector, bulb and valve)



Used with	Double tube with BP09 connector	Single tube with BP15 connector	Double tube without connector	Single tube without connector
REF#	SP/S-C0909-B01-10	SP/S-C15-B01-10	SP/S-CD-B01-10	SP/S-CS-B01-10
Package	10pcs/bag	10pcs/bag	10pcs/bag	10pcs/bag
Price (bag)	D6.7	D6.7	D6.7	D6.7

## 6.3 Parts

Image	REF#	Description	Package	Price (box)
	U1880HS U1880HD	Reusable adult(25-35cm) 1 or 2 tube BP cuff with clip	1 pc/box	B5
	Y02-H005	Coiled black single tube, 3.8m, 4.0mm	1 pc/box	B4
	Y15-S001	Pocket aneroid gauge, reusable, gray	1 pc/box	B2
	Y14-L001-5	Bulb&valve, reusable, black	5 pcs/box	B6



# 7 Tourniquet

## Specification

- Strong gentle nylon materials for thousands circles of inflation and deflation
- Reusable for multiple patient use
- Convenient and easy to clean
- Come with 50cm PVC tube
- Latex free

Size Type	Cuff Size(mm)	REF#(Single Tube)	REF#(DoubleTube)	Package	Price (box)
Small	50*400	T1880S	T1880D	1pc/box	A8
Medium	70*500	T1881S	T1881D	1pc/box	B1
Large	80*800	T1882S	T1882D	1pc/box	B2
Variety(each of the above item)	See above	T1801S-03	T1801D-03	total 3pcs/box	B8



## 8 Phototherapy Mask



Phototherapy masks have been designed to aid newborn babies suffering from jaundice. This product could provide superior light-blocking protection on baby's eyes when it is under phototherapy treatment or anytime a baby's eyes need protection. It is made from a latex-free soft material, ensures a perfect fit. Available in 3 sizes in order to adapt to baby's head of different circumference from 20cm to 38cm, ensuring a perfect fit on every neonatal patient.

### Specification

- Phototherapy Masks are made from a very soft velvet-fabrics foam which is comfortable and gentle on baby's skin.
- The single-piece, wrap around design could firmly attach the head of babies to prevent unwanted movement and allows perfect fit
- Superior block light with wavelength less than 800nm and other harmful waves to baby's eyes while headband design allows phototherapy light to reach baby's head.
- Large selection of 13 sizes cuffs matching the different sizes patients
- Under biocompatibility and physical test
- Single patient use only
- Latex-free

Size	Head Circumference	REF#	Color code	Package	Price (box)
Small	20-25cm	<b>UBE-S01-10</b>	Green	10pcs/box	B8.1
Medium	25-32cm	<b>UBE-M01-10</b>	Orange	10pcs/box	B8.1
Large	32-38cm	<b>UBE-L01-10</b>	Blue	10pcs/box	B8.1

## 9 Pressure Infusion Bag



### Disposable Pressure Infusion Bag

Features: Single patient use. Gauge safety valve prevents over-inflation(320 mmHg pressure relief) .Colour coded gauge (0-300mmHg) for easy monitoring pressure .  
Configuration: Hook, Air Bladder, Pressure Gauge, Pressure Relief Valve, Inflatable Bulb, Air Tubes

REF#	Description	Package	Price (unit)
<b>DPI-500</b>	Disposable pressure infusion bag, 500ml, white	20 pcs/case	B6.5
<b>DPI-1000</b>	Disposable pressure infusion bag, 1000ml, white	15 pcs/case	B6.6



### Semi Reusable Pressure Infusion Bag

Features: Durable, easy-to-clean, can be re-used if desired. Manometer is precise, stable and shockproof  
Configuration: Hook, Air Bladder, Non-stop Pin Manometer, Pressure Relief Valve, Inflatable Bulb, Air Tubes

REF#	Description	Package	Price (unit)
<b>HPI-500</b>	Semi reusable pressure infusion bag, 500ml, dark slate gray	20 pcs/case	B7
<b>HPI-1000</b>	Semi reusable pressure infusion bag, 1000ml, dark slate gray	15 pcs/case	B7.9



### Reusable Pressure Infusion Bag

Features: More durable and hardwearing for the design of built-in air bladder. Easy-to-clean.can be re-used if desired. Parts are easy-to-replace due to threaded connectors used. Manometer is precise, stable and shockproof  
Configuration: Hook, Bladder bag, Bolt-in Air Bladder, Non-stop Pin Manometer, Pressure Relief Valve, Inflatable Bulb, Air Tubes

REF#	Description	Package	Price (unit)
<b>PI-500</b>	Reusable pressure infusion bag, 500ml, dark slate blue	20 pcs/case	C1.3
<b>PI-1000</b>	Reusable pressure infusion bag, 1000ml, dark slate blue	15 pcs/case	C1.4

### Reusable Accessories

Picture	REF#	Description	Price(unit)
	Y15-B005	500ml Built-in air bladder with air tubes	<b>B4.1</b>
	Y15-B006	1000ml Built-in air bladder with air tubes	<b>B5</b>
	Y15-S001	Manometer	B2

Picture	REF#	Description	Price(unit)
	Y15-P001	500ml Bladder bag	B3
	Y15-P002	1000ml Bladder bag	B4
	Y14-L008-01	Bulb with valve	A3





## IBP Interface Cable & Transducer

- 1. IBP Adapter Cable for Transducer ..... 221
- 2. IBP Convert Cable ..... 237
- 3. IBP Transducer Adapter ..... 239
- 4. IBP Disposable Transducer ..... 240

### Certification









### Compliance with

- IEC 60601-1
- IEC 60601-2-34
- ISO 10993-1
- ISO 10993-5
- ISO 10993-10
- ISO 10993-23



### Available Cables for Disposable Transducer

- Argon (AG)
- 
- B.Braun (BB)
- 
- B.D. (BD)
- 
- Edwards (ED)
- 
- Medex/Abbort (MX)
- 
- Utah (UT)
- 
- PVB
- 

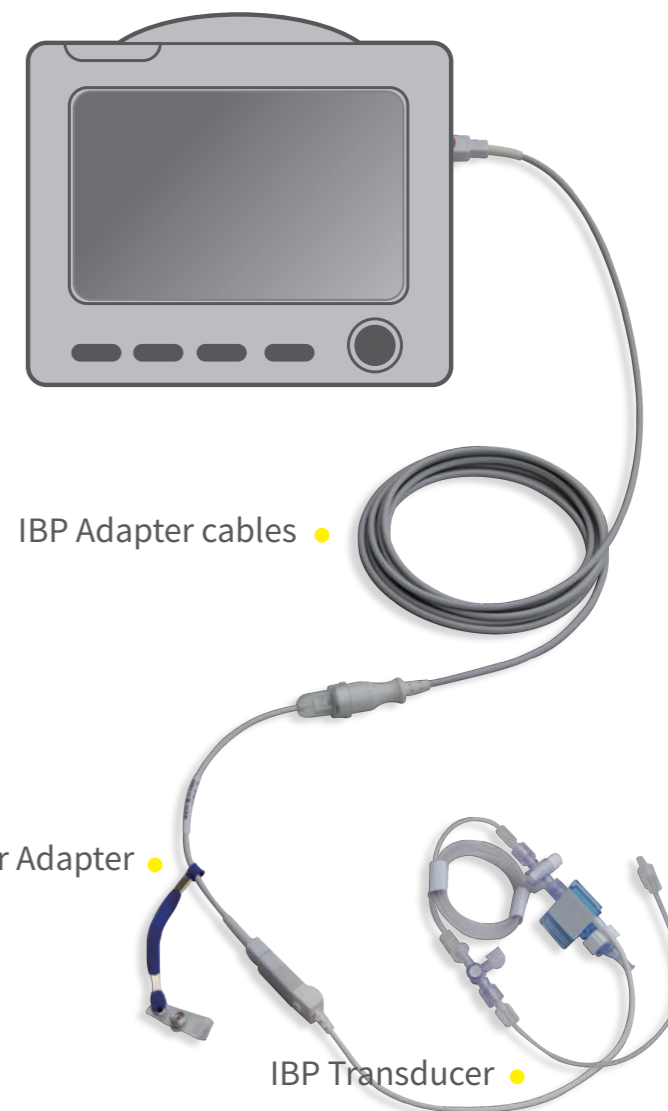

## 1 IBP Adapter Cable for Transducer

### Compatible with Major Patient Monitor Brands

Datex-Ohmeda  
 Datascope-Mindray  
 Marquette  
 Nihon kohden  
 Philips  
 Spacelabs  
 Siemens  
 ...

### Specification

<b>Cable material</b>	TPU Jacket, Gray
<b>Connector</b>	Nylon plug & Golden plated pins
<b>Cable length</b>	4.0m/0.3m
<b>Cable Diameter</b>	5.00mm

### Reference Number Rule Description

BC-HP-UT/2	
BC	IBP cable
HP	Factory/model (see others above)
UT	Utah( transducer type)
2	the number of channel, default is single channel

### Available cables for reusable transducer

Medex Logical/MX960



Transducer Type	Mindray	Argon	B.Braun	BD	Edwards	Medex / Abbott	Utah	Medex Logical	PVB	Cable Length	Cable Connector on Monitor End
Cable connector on transducer end											
<b>AAMI</b>											
	BC-6P-MIR	BC-6P-AG	BC-6P-BB	BC-6P-BD (001C-30-70758 / 684085)	BC-6P-ED (0010-21-43094 / 8000-0665)	BC-6P-MX (42661-14)	BC-6P-UT (650-208)	BC-6P-MX1	BC-6P-PVB	4.0m	
	C3	C3	C3	C3	C3	C3	C3	C3	C3		
<b>BARD Medical</b>											
	BC-BR-MIR	BC-BR-AG	BC-BR-BB	BC-BR-BD	BC-BR-ED	BC-BR-MX	BC-BR-UT	BC-BR-MX1	BC-BR-PVB	4.0m	
	C4	C4	C4	C4	C4	C4	C4	C4	C4		
<b>Biolight</b>											
V6 Vital Sign View A2/A3/A5/A6/A6	BC-BLT-MIR	BC-BLT-AG	BC-BLT-BB	BC-BLT-BD	BC-BLT-ED	BC-BLT-MX	BC-BLT-UT	BC-BLT-MX1	BC-BLT-PVB	4.0m	
	C3	C3	C3	C3	C3	C3	C3	C3	C3		
<b>Colin</b>											
	BC-CL-MIR	BC-CL-AG	BC-CL-BB	BC-CL-BD	BC-CL-ED	BC-CL-MX	BC-CL-UT	BC-CL-MX1	BC-CL-PVB	4.0m	
	C5	C5	C5	C5	C5	C5	C5	C5	C5		
<b>Comen</b>											
C50/C60/70/C80/C90/NC8	N/A	BC-CM-AG	BC-CM-BB	BC-CM-BD	BC-CM-ED	BC-CM-MX	BC-CM-UT	BC-CM-MX1	BC-CM-PVB	4.0m	
	N/A	C3	C3	C3	C3	C3	C3	C3	C3		
<b>Criticare</b>											
Matrix, Scholar 2200	BC-CSI-MIR	BC-CSI-AG	BC-CSI-BB	BC-CSI-BD (684175)	BC-CSI-ED	BC-CSI-MX	BC-CSI-UT	BC-CSI-MX1	BC-CSI-PVB	4.0m	
	C5	C5	C5	C5	C5	C5	C5	C5	C5		
<b>Draeger/Dräger &gt; Siemens</b>											
SC 7000, SC 8000, SC 9000, SC 9000XL, Sirecust 1260, Sirecust 1281	BC-SM1-MIR	BC-SM1-AG	BC-SM1-BB	BC-SM1-BD (684082)	BC-SM1-ED	BC-SM1-MX	BC-SM1-UT (650-203)	BC-SM1-MX1	BC-SM1-PVB	4.0m	
	C4	C4	C4	C4	C4	C4	C4	C4	C4		
	N/A	BC-SM1-AG/2	BC-SM1-BB/2	BC-SM1-BD/2	BC-SM1-ED/2	BC-SM1-MX/2	BC-SM1-UT/2	BC-SM1-MX1/2	BC-SM1-PVB/2	4.0m	
	N/A	D1	D1	D1	D1	D1	D1	D1	D1		
Infinity Delta, Infinity Kappa, Infinity Vista, PB8800, PM8010, PM8014, PM8040, PM8060	BC-SM2-MIR	BC-SM2-AG	BC-SM2-BB	BC-SM2-BD (MS22148 / 3375933)	BC-SM2-ED (MS22147 / 896140-021)	BC-SM2-MX (MS22535)	BC-SM2-UT (MS22534)	BC-SM2-MX1	BC-SM2-PVB	4.0m	
	C4	C4	C4	C4	C4	C4	C4	C4	C4		
	N/A	BC-SM2-AG/2	BC-SM2-BB/2	BC-SM2-BD/2	BC-SM2-ED/2 (5206607)	BC-SM2-MX/2 (5206573)	BC-SM2-UT/2	BC-SM2-MX1/2	BC-SM2-PVB/2	4.0m	
	N/A	D1	D1	D1	D1	D1	D1	D1	D1		
Cato, Cicero EM, PB8800, PM8010, PM8014, PM8040, PM8060, Sulla, UM3, UM3.1, Vitara	BC-DG-MIR	BC-DG-AG	BC-DG-BB	BC-DG-BD	BC-DG-ED	BC-DG-MX	BC-DG-UT	BC-DG-MX1	BC-DG-PVB	4.0m	
	C4	C4	C4	C4	C4	C4	C4	C4	C4		
Infinity Delta, Infinity Delta XL, Infinity Gamma XXL, Infinity Kappa	N/A	BC-S-AG/2	BC-S-BB/2	BC-S-BD/2	BC-S-ED/2	BC-S-MX/2	BC-S-UT/2	BC-S-MX1/2	BC-S-PVB/2	4.0m	
	N/A	DD1	DD1	DD1	DD1	DD1	DD1	DD1	DD1		
<b>DRE</b>											
Waveline EZ, Touch and Pro	N/A	BC-DRE-AG	BC-DRE-BB	BC-DRE-BD	BC-DRE-ED	BC-DRE-MX	BC-DRE-UT	BC-DRE-MX1	BC-DRE-PVB	4.0m	
	N/A	C3.8	C3.8	C3.8	C3.8	C3.8	C3.8	C3.8	C3.8		
<b>Emtel</b>											
FX-2000/3000 FX-3000C/3000MD DefiMax Plus	BC-ET-MIR	BC-ET-AG	BC-ET-BB	BC-ET-BD	BC-ET-ED	BC-ET-MX	BC-ET-UT (P02118)	BC-ET-MX1	BC-ET-PVB	4.0m	
	C4	C4	C4	C4	C4	C4	C4	C4	C4		
<b>Feas</b>											
	BC-FS-MIR	BC-FS-AG	BC-FS-BB	BC-FS-BD	BC-FS-ED	BC-FS-MX	BC-FS-UT	BC-FS-MX1	BC-FS-PVB	4.0m	
	C7	C7	C7	C7	C7	C7	C7	C7	C7		

Transducer Type	Mindray	Argon	B.Braun	BD	Edwards	Medex / Abbott	Utah	Medex Logical	PVB	Cable Length	Cable Connector on Monitor end
Cable connector on transducer end											
<b>Fukuda Denshi</b>											
Dynascope DS-5100E/ DS-5300W/DS-5400/ DS-7001	BC-FD-MIR	BC-FD-AG	BC-FD-BB	BC-FD-BD	BC-FD-ED	BC-FD-MX	BC-FD-UT	BC-FD-MX1	BC-FD-PVB	4.0m	
	C4	C4	C4	C4	C4	C4	C4	C4	C4		
DS-8100/DS-8200 /DS-8400/DS-8500/ DS-8700	N/A	BC-FD1-AG	N/A	BC-FD1-BD (CJO-P01B-SB3.6/ 550215650)	BC-FD1-ED	BC-FD1-MX	N/A	N/A	N/A	4.0m	
	N/A	C7	N/A	C7	C7	C7	N/A	N/A	N/A		
<b>GE-Corometrics</b>											
120	BC-CR-MIR	BC-CR-AG	BC-CR-BB	BC-CR-BD	BC-CR-ED	BC-CR-MX	BC-CR-UT	BC-CR-MX1	BC-CR-PVB	4.0m	
	C5	C5	C5	C5	C5	C5	C5	C5	C5		
<b>GE-Datex</b>											
AS/3,AS/5,CC-104, Cardiocap I, Cardiocap II, Cardiocap/5	BC-DX-MIR	BC-DX-AG	BC-DX-BB	BC-DX-BD (682000/684104)	BC-DX-ED	BC-DX-MX	BC-DX-UT (650-217)	BC-DX-MX1	BC-DX-PVB	4.0m	
	C5	C5	C5	C5	C5	C5	C5	C5	C5		
<b>GE-Hellige</b>											
SMU 610, SMU 611, SMU 612, SMU 613, SMU 639, Vicom SM	BC-HL-MIR	BC-HL-AG	BC-HL-BB	BC-HL-BD	BC-HL-ED	BC-HL-MX	BC-HL-UT	BC-HL-MX1	BC-HL-PVB	4.0m	
	C3.8	C3.8	C3.8	C3.8	C3.8	C3.8	C3.8	C3.8	C3.8		
<b>GE-Marquette</b>											
Dash 1000, Dash 2000, Dash 3000, Dash 3100, Dash 4000, Dash 5000, Eagle, MAC-Lab, PDM Module, E-PRESTN	BC-MQ-MIR	BC-MQ-AG (2104166-001)	BC-MQ-BB (22339301)	BC-MQ-BD (2016995-001 / 684102)	BC-MQ-ED (2021197-001 / 2104162-001)	BC-MQ-MX (2021196-001)	BC-MQ-UT (2016997-001 / 650-236)	BC-MQ-MX1	BC-MQ-PVB	4.0m	
	C3.8	C3.8	C3.8	C3.8	C3.8	C3.8	C3.8	C3.8	C3.8		
	N/A	BC-MQ-AG/2 (2104166-003)	BC-MQ-BB/2	BC-MQ-BD/2 (2016995-003)	BC-MQ-ED/2 (2021197-003 / 2104162-003)	BC-MQ-MX/2 (2021196-003)	BC-MQ-UT/2 (2016997-003)	BC-MQ-MX1/2	BC-MQ-PVB/2	4.0m	
	N/A	D1	D1	D1	D1	D1	D1	D1	D1		
	BC-MT-MIR	BC-MT-AG	BC-MT-BB	BC-MT-BD	BC-MT-ED	BC-MT-MX	BC-MT-UT	BC-MT-MX1	BC-MT-PVB	4.0m	
	C8	C8	C8	C8	C8	C8	C8	C8	C8		
<b>GE-Prucka</b>											
	N/A	BC-GE1-AG	BC-GE1-BB	BC-GE1-BD	BC-GE1-ED	BC-GE1-MX	BC-GE1-UT	BC-GE1-MX1	BC-GE1-PVB	4.0m	
	N/A	C3	C3	C3	C3	C3	C3	C3	C3		
<b>Guoteng</b>											
GT9000/9000C GT90001/9002 GT9003A/9003B	BC-GT-MIR	BC-GT-AG	BC-GT-BB	BC-GT-BD	BC-GT-ED	BC-GT-MX	BC-GT-UT	BC-GT-MX1	BC-GT-PVB	4.0m	
	C4	C4	C4	C4	C4	C4	C4	C4	C4		
<b>Huanan Medical</b>											
	BC-HY-MIR	BC-HY-AG	BC-HY-BB	BC-HY-BD	BC-HY-ED	BC-HY-MX	BC-HY-UT	BC-HY-MX1	BC-HY-PVB	4.0m	
	C5	C5	C5	C5	C5	C5	C5	C5	C5		
<b>IGEL</b>											
	BC-IG-MIR	BC-IG-AG	BC-IG-BB	BC-IG-BD	BC-IG-ED	BC-IG-MX	BC-IG-UT	BC-IG-MX1	BC-IG-PVB	4.0m	
	C3.8	C3.8	C3.8	C3.8	C3.8	C3.8	C3.8	C3.8	C3.8		
<b>JJET</b>											
XDY-2003A/B	BC-JJ-MIR	BC-JJ-AG	BC-JJ-BB	BC-JJ-BD	BC-JJ-ED	BC-JJ-MX	BC-JJ-UT	BC-JJ-MX1	BC-JJ-PVB	4.0m	
	C3.8	C3.8	C3.8	C3.8	C3.8	C3.8	C3.8	C3.8	C3.8		
<b>Kontron</b>											
7000 Series, Fetalmon 2B Fetalogic 4000, IAB Balloon Pump, K2000, Minimon, Supermon	BC-KTN-MIR	BC-KTN-AG	BC-KTN-BB	BC-KTN-BD	BC-KTN-ED	BC-KTN-MX	BC-KTN-UT	BC-KTN-MX1	BC-KTN-PVB	4.0m	
	C4	C4	C4	C4	C4	C4	C4	C4	C4		
<b>Kopran</b>											
S3 Heart Lung Machine	BC-KR-MIR	BC-KR-AG	BC-KR-BB	BC-KR-BD	BC-KR-ED	BC-KR-MX	BC-KR-UT	BC-KR-MX1	BC-KR-PVB	4.0m	
	C5	C5	C5	C5	C5	C5	C5	C5	C5		



Transducer Type	Mindray	Argon	B.Braun	BD	Edwards	Medex / Abbott	Utah	Medex Logical	PVB	Cable Length	Cable Connector on Monitor End
Cable connector on transducer end											
<b>Larsen &amp; Toubro/L&amp;T</b>											
	BC-LT-MIR	BC-LT-AG	BC-LT-BB	BC-LT-BD	BC-LT-ED	BC-LT-MX	BC-LT-UT	BC-LT-MX1	BC-LT-PVB	4.0m	
	C4	C4	C4	C4	C4	C4	C4	C4	C4		
<b>MEK</b>											
	BC-MEK-MIR	BC-MEK-AG	BC-MEK-BB	BC-MEK-BD	BC-MEK-ED	BC-MEK-MX	BC-MEK-UT	BC-MEK-MX1	BC-MEK-PVB	4.0m	
	C3.8	C3.8	C3.8	C3.8	C3.8	C3.8	C3.8	C3.8	C3.8		
<b>Mennen</b>											
Envoy, Vitalogik 5500	BC-MN-MIR	BC-MN-AG	BC-MN-BB	BC-MN-BD	BC-MN-ED	BC-MN-MX	BC-MN-UT	BC-MN-MX1	BC-MN-PVB	4.0m	
	C3.8	C3.8	C3.8	C3.8	C3.8	C3.8	C3.8	C3.8	C3.8		
<b>Mindray &gt; Datascope</b>											
BeneVision, BeneView, iPM, IMEC series monitors	BC-MR-MIR (IM2205/115-020486-00)	BC-MR-AG	BC-MR-BB (IM2207/0010-21-43082)	BC-MR-BD (IM2202/001C-30-70757)	BC-MR-ED (IM2211/0010-21-12179)	BC-MR-MX (IM2201/001C-30-70759)	BC-MR-UT (650-206/IM2206/115-017849-00)	BC-MR-MX1	BC-MR-PVB	4.0m	
	C3	C3	C3	C3	C3	C3	C3	C3	C3		
System,80,82,83,84,90,90T,95,98,97,850,870,P2,P3,2000,2000A,2001,2001A,2002,2002A,22001,3000	BC-DT-MIR	BC-DT-AG	BC-DT-BB	BC-DT-BD (0012-00-1245/684078)	BC-DT-ED (040-000054-00)	BC-DT-MX (040-000052-00)	BC-DT-UT (650-204)	BC-DT-MX1	BC-DT-PVB	4.0m	
	C3.8	C3.8	C3.8	C3.8	C3.8	C3.8	C3.8	C3.8	C3.8		
Passport V, V12, V21, V-Series	BC-DT1-MIR	BC-DT1-AG	BC-DT1-BB	BC-DT1-BD	BC-DT1-ED	BC-DT1-MX	BC-DT1-UT	BC-DT1-MX1	BC-DT1-PVB	4.0m	
	C3.8	C3.8	C3.8	C3.8	C3.8	C3.8	C3.8	C3.8	C3.8		
<b>Mostcare</b>											
	BC-MC-MIR	BC-MC-AG	BC-MC-BB	BC-MC-BD	BC-MC-ED	BC-MC-MX	BC-MC-UT	BC-MC-MX1	BC-MC-PVB	4.0m	
	C3.8	C3.8	C3.8	C3.8	C3.8	C3.8	C3.8	C3.8	C3.8		
<b>Nihon Kohden</b>											
Lifescope/BSM series	BC-NK1-MIR	BC-NK1-AG	BC-NK1-BB	BC-NK1-BD	BC-NK1-ED	BC-NK1-MX	BC-NK1-UT	BC-NK1-MX1	BC-NK1-PVB	4.0m	
	C5	C5	C5	C5	C5	C5	C5	C5	C5		
BSM-6000 series, BSM-6301K, BSM-6501K, BSM-6701K, BSM-9101K, Life Scope J, Life Scope TR	BC-NK2-MIR	BC-NK2-AG	BC-NK2-BB	BC-NK2-BD (JP-900P)	BC-NK2-ED (JP-920P/JP-921P/JP-903P)	BC-NK2-MX	BC-NK2-UT (JP-960P)	BC-NK2-MX1	BC-NK2-PVB	4.0m	
	C8	C8	C8	C8	C8	C8	C8	C8	C8		
SVM-7503, SVM-7600	BC-NK3-MIR	BC-NK3-AG	BC-NK3-BB	BC-NK3-BD	BC-NK3-ED	BC-NK3-MX	BC-NK3-UT	BC-NK3-MX1	BC-NK3-PVB	4.0m	
	C5	C5	C5	C5	C5	C5	C5	C5	C5		
<b>Philips</b>											
78341A, 78342A, 78352A, 78354C, M1006A, M1006B, M1026A, M1165A, M1166A, M1205A, M1350A, M1350B, M1353A, M2, M3, M4, MP 70	BC-HP-MIR	BC-HP-AG	BC-HP-BB (M1634A)	BC-HP-BD (684081)	BC-HP-ED (896083021)	BC-HP-MX (42661-27/MX95102)	BC-HP-UT (650-206)	BC-HP-MX1	BC-HP-PVB	4.0m	
	C3.8	C3.8	C3.8	C3.8	C3.8	C3.8	C3.8	C3.8	C3.8		
<b>Sarans</b>											
	BC-SR-MIR	BC-SR-AG	BC-SR-BB	BC-SR-BD	BC-SR-ED	BC-SR-MX	BC-SR-UT	BC-SR-MX1	BC-SR-PVB	4.0m	
	D1.3	D1.3	D1.3	D1.3	D1.3	D1.3	D1.3	D1.3	D1.3		
<b>Spacelabs</b>											
Ultraview 90496, 91496	BC-SL-MIR	BC-SL-AG	BC-SL-BB	BC-SL-BD	BC-SL-ED (700-0293-00)	BC-SL-MX (700-0295-00)	BC-SL-UT	BC-SL-MX1	BC-SL-PVB	4.0m	
	D1	D1	D1	D1	D1	D1	D1	D1	D1		
	N/A	BC-SL-AG/2	BC-SL-BB/2	BC-SL-BD/2	BC-SL-ED/2 (700-0292-00)	BC-SL-MX/2 (700-0294-00)	BC-SL-UT/2	BC-SL-MX1/2	BC-SL-PVB/2	4.0m	
	N/A	DD1	DD1	DD1	DD1	DD1	DD1	DD1	DD1		
300, 400, 500, 600, 700, 90308, 90311, 90331, 90402, 90403, 90470, 90496, 90603A, 91496	BC-6P-MIR	BC-6P-AG	BC-6P-BB	BC-6P-BD (690-0021-00)	BC-6P-ED (0010-21-43094/8000-0665)	BC-6P-MX	BC-6P-UT	BC-6P-MX1	BC-6P-PVB	4.0m	
	C3	C3	C3	C3	C3	C3	C3	C3	C3		

Transducer Type	Mindray	Argon	B.Braun	BD	Edwards	Medex / Abbott	Utah	Medex Logical	PVB	Cable Length	Cable Connector on Monitor End
Cable connector on transducer end											
<b>Stockert</b>											
	N/A	BC-SK-AG	BC-SK-BB	BC-SK-BD	BC-SK-ED	BC-SK-MX	BC-SK-UT	BC-SK-MX1	BC-SK-PVB	4.0m	
	N/A	D1	D1	D1	D1	D1	D1	D1	D1		

<b>Dräger-Infinity</b>											
Transducer Type	Mindray	Argon	B.Braun	BD	Baxter-Edwards	Medex / Abbott	Utah	Cable Length	Cable Connector on Monitor End		
Cable Connector on transducer End	/	/	/								
Mpod-Quad Hemo M cable-Dual Hemo	/	/	/	OT-035 (MS22148)	OT-034 (MS22147)	OT-027 (MS22535)	OT-036 (MS22534)	0.33m			
	/	/	/	B4	B4	B3	B4				

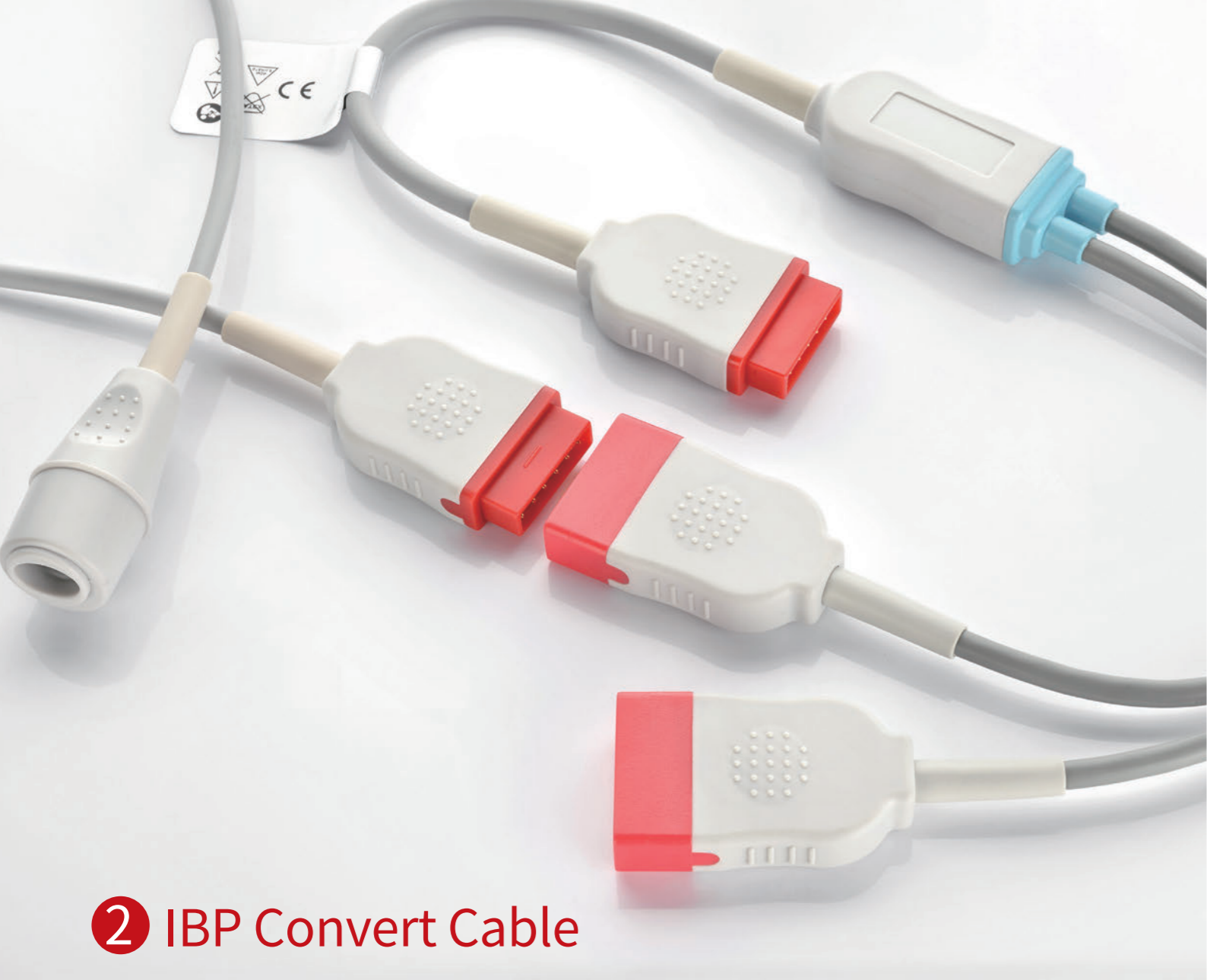

## 2 IBP Convert Cable

### Reference Number Rule Description

BC-SL-AD/2	
BC	IBP cable
SL	Factory/model (see others on previous page)
AD	Convert Cable.AD: Converted to AAMI Adapter(MQ: to marquette;SM1 or SM2: to Siemens)
2	2-channel,default is single channel

Monitor End Connector	Unimed REF#	OEM PN	Used with	Cable Length	Monitor End Connector	Price (unit)
<b>Philips</b>						
	BC-HP-HP/2	989803199741	BC-HP-"XX" (Dual Channel IBP Cable)	0.3+0.3m		D1.5
<b>Fukuda Denshi</b>						
	BC06-FD2-FD/2	CJO-P01B-DJ0.5 550215630	BC-FD1-"XX" (Dual Channel IBP Cable)	0.6m		D1.4
<b>Nihon Kohden</b>						
	BC-NK2-NK1	K952 JP-910P	BC-NK1-"XX" (Single Channel IBP Cable)	0.4m		C4

Monitor End Connector	Unimed REF#	OEM PN	Used with	Cable Length	Monitor End Connector	Price (unit)
<b>Draeger/Dräger &gt; Siemens</b>						
	BC-S-SM1/2	5731281	BC-SM1-"XX" (Dual Channel IBP Cable)	0.3m		DD2
	BC-S-SM2/2	5592147	BC-SM2-"XX" (Dual Channel IBP Cable)	0.3m		DD2
	BC-SM2-SM1/2	5588095	BC-SM1-"XX" (Dual Channel IBP Cable)	0.3m		C7
	BC-SM2-SM1	3368383	BC-SM1-"XX" (Single Channel IBP Cable)	0.3m		C1.4
	BC-SM1-SM2	3368383	BC-SM2-"XX" (Single Channel IBP Cable)	0.3m		C1.4
<b>GE-Marquette</b>						
	BC-MQ-AD		BC-6P-"XX" (Single Channel IBP Cable)	0.3m		C4
	BC-MQ-AD/2		BC-6P-"XX" (Dual Channel IBP Cable)	0.3m		C8
	BC-MQ-MQ/2	2005772-001	BC-MQ-"XX" (Dual Channel IBP Cable)	0.3+m		DD1
<b>Mindray &gt; Datascope</b>						
	BC-MR-AD	0010-20-42795	BC-6P-"XX" (Single Channel IBP Cable)	0.3m		C2
	BC-MR-AD/2		BC-6P-"XX" (Dual Channel IBP Cable)	0.3m		C7
	BC-MR-MR/2	IM2204 040-001029-00	BC-MR-"XX" (Dual Channel IBP Cable)	0.3+0.3m		C8.7
	BC-DT1-AD	040-000096-00	BC-6P-"XX" (Single Channel IBP Cable)	0.3m		C1.4
<b>Spacelabs</b>						
	BC-SL-AD	700-0791-00	BC-6P-"XX" (Single Channel IBP Cable)	0.3m		C8.1
	BC-SL-AD/2	700-0028-00	BC-6P-"XX" (Dual Channel IBP Cable)	0.3m		D1

# 3 IBP Transducer Adapter

## Reference Number Rule Description



BC-BD-MX	
BC	IBP cable
BD	IBP Adapter Cable Connector End BD Type
MX	Utah( UT); Argon (AG); B.Braun (BB); BD (BD); Edwards (ED); Medex/Abbot (MX); MX: Used with Medex/Abbot Disposable Transducer

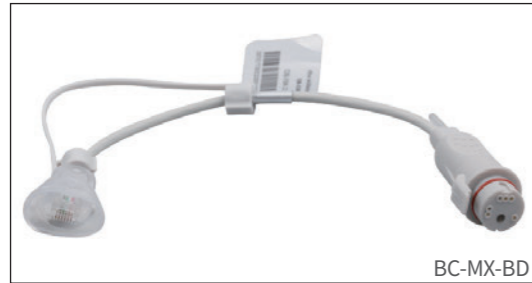

## Used with Brands IBP Adapter Cable & Major Types Disposable Transducer

Used with Transducer Type	Used with brands ibp adapter cable & connector end (transducer connector end)					
	Unimed REF#	B.Braun	BD	Medex / Abbott	Utah	Cable Length
<b>GE-Marquette</b>						
	<b>Unimed REF#</b>	<b>BC-BB-AG</b>	<b>BC-BD-AG</b>	<b>BC-MX-AG</b>	<b>BC-UT-AG</b>	0.3m
	Price (unit)	B8	C1	B8	C1.4	
<b>B.Braun</b>						
	<b>Unimed REF#</b>	/	<b>BC-BD-BB</b>	<b>BC-MX-BB</b>	<b>BC-UT-BB</b>	0.3m
	Price (unit)	/	C1	B8	C1.4	
<b>BD</b>						
	<b>Unimed REF#</b>	<b>BC-BB-BD</b>	/	<b>BC-MX-BD</b>	<b>BC-UT-BD</b>	0.3m
	Price (unit)	B8	/	B8	C1.4	
<b>Baxter-Edwards</b>						
	<b>Unimed REF#</b>	<b>BC-BB-ED</b>	<b>BC-BD-ED</b>	<b>BC-MX-ED</b>	<b>BC-UT-ED</b>	0.3m
	Price (unit)	B8	C1	B8	C1.4	
<b>Medex/Abbot</b>						
	<b>Unimed REF#</b>	<b>BC-BB-MX</b>	<b>BC-BD-MX</b>	/	<b>BC-UT-MX</b>	0.3m
	Price (unit)	B8	C1	/	C1.4	
<b>Utah</b>						
	<b>Unimed REF#</b>	<b>BC-BB-UT</b>	<b>BC-BD-UT</b>	<b>BC-MX-UT</b>	/	0.3m
	Price (unit)	B8	C1	B8	/	
<b>Medex Logical</b>						
	<b>Unimed REF#</b>	<b>BC-BB-MX1</b>	<b>BC-BD-MX1</b>	<b>BC-MX-MX1</b>	<b>BC-UT-MX1</b>	0.3m
	Price (unit)	B8	C1	B8	C1.4	



• Please refer to the additional Transducer catalogue

# 4 Disposable Transducer



UTAH

MEDEX

B.BRAUN

BD

EDWARD





# Temperature Probe & Interface Cable

- 1. Reusable Temp. Probe** ..... 243
  - 1.1 Reusable Temp. Probe ..... 244
  - 1.2 Temp. Adapter Cable For Reusable Probe ..... 247
- 2. Disposable Temp. Probe** ..... 250
  - 2.1 Disposable Skin, Esophageal/Rectal Temp. Probe ..... 251
  - 2.2 Disposable Tympanic Temp. Probe ..... 252
  - 2.3 Foley Catheter Temp. Probe ..... 252
  - 2.4 Disposable Esophageal Stethoscope Temp. Probe ..... 253
  - 2.4a Accessories ..... 253
  - 2.5 Temp. Adapter Cable For Disposable Probe ..... 254
- 3. Smart Temp. Probe** ..... 256
  - 3.1 Smart Temp.Probe ..... 257

### Certification



### Compliance with

- EN12470-4
- IEC 60601-1
- ISO 10993-1
- ISO 10993-5
- ISO 10993-10
- ISO 10993-23
- ISO 80601-2-56

### Compatibility

Major Brands Temperature Monitoring System

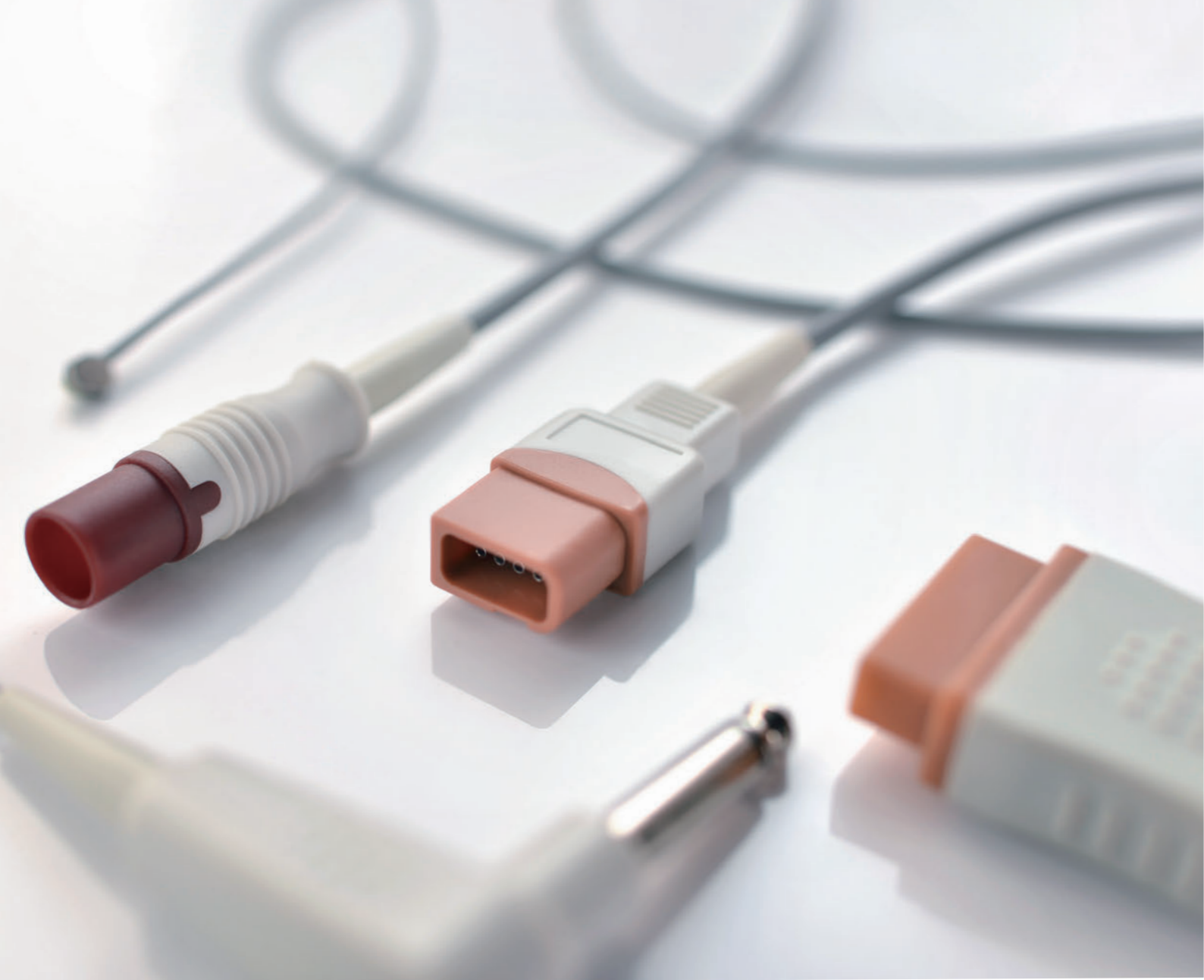

# 1.1 Reusable Temp. Probe

## Reference Number Rule Description

TSM2-15AS	
T	Temperature probe
SM	Factory/model (See others left)
2	2 channel(Default is single channel)
15	1.5m Cable Length(Default:=3.0m)
A	Adult(P= Pediatric)
S	Skin(G=general purpose)

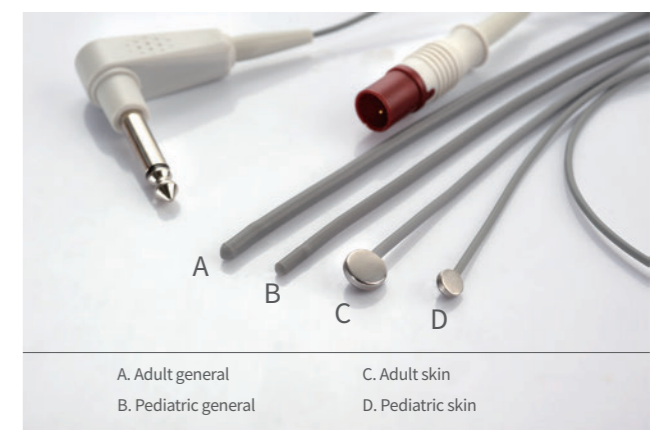

# 1 Reusable Temp. Probe

### Compatible with Major Patient Monitor Brands

- Air Shielded(AS) Spacelabs(SL)
- Datex-Ohmeda(DX) Siemens(SM)
- Marquette(MQ) YSI(YSI)
- Philips(HP)

### Features



















- Accurate measurement
- Quick response
- Low noise signal transfer
- Fully compatible with OEM technology
- 12 month warranty







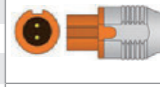

### Specification

<b>Probe type</b>	General purpose; Skin
<b>Cable Length</b>	3.0m/1.5m;unless requirement applied
<b>Cable diameter</b>	2.0/2.60mm(Skin purpose) 4.00mm(General purpose)
<b>Resister type</b>	NTC/YSI400/2.252K@25°C
<b>Cable material</b>	TPU jacket ,Light gray
<b>Connector</b>	Golden plated pins

OEM & Models	Unimed REF#	OEM REF#	Application	Cable Length	Monitor End Plug	Price (unit)
<b>Air Temperature</b>						
(100K Ω@25 °C)	T100-GP		for air temperature measurement	2.0m		C1
<b>Artema/S&amp;W</b>						
(2.252K Ω@25 °C)	TSW-AS	T1032	Adult Skin	3.0m		C3
	TSW-PS		Pediatric Skin	3.0m		C4
	TSW-AG		Adult General	3.0m		C3
	TSW-PG	T2302	Pediatric General	3.0m		C4
<b>Atom</b>						
Infant Incubator V-2100G, V-3200D, Transport Incubator V-707, V-2200, V-505, V-808(2.05K Ω@25 °C)	TAT-AS		Adult Skin	3.0m		B7
	TAT-PS		Pediatric Skin	3.0m		B8
	TAT-AG		Adult General	3.0m		B7
	TAT-PG		Pediatric General	3.0m		B8
<b>Beijing Julongsanyou</b>						
Infant Radiant Warmer BNT-1000/ BNT-2000/BNT-2000B(20K Ω@25 °C) (6.3mm Mono Stereo Plug)	T20-15PS		Pediatric Skin	1.5m		B6.6
	T20-PS		Pediatric Skin	3.0m		B7
Infant Incubator B-800/B-1000/B-2000/B-3000 (20K Ω@25 °C)	TBNT-15PS		Pediatric Skin	1.5m		B6.7
	TBNT-PS		Pediatric Skin	3.0m		B7.9
<b>Biolight</b>						
AnyView A2/A3/A5/A6/A8 V6 Vital Sign (2.252K Ω@25 °C)	TBLT-AS		Adult Skin	3.0m		C1.3
	TBLT-PS		Pediatric Skin	3.0m		C2
	TBLT-AG		Adult General	3.0m		C1.3
	TBLT-PG		Pediatric General	3.0m		C2
<b>Comen</b>						
C100,C90,C70,C60,C50,C30, C20,NC8,NC10,NC12 (2.252K Ω@25 °C)	TCMA-AS		Adult Skin	3.0m		B7
	TCMA-PS		Pediatric Skin	3.0m		B8
	TCMA-AG		Adult General	3.0m		B7
	TCMA-PG		Pediatric General	3.0m		B8
C100,C90,C70,C60,C50,C30, C20,NC8,NC10,NC12 (10K Ω@25 °C)	TCMB-AS		Adult Skin	3.0m		B7
	TCMB-PS		Pediatric Skin	3.0m		B8
	TCMB-AG		Adult General	3.0m		B7
	TCMB-PG		Pediatric General	3.0m		B8
<b>David</b>						
HKN-90/HKN-93/KN-93A/ HKN-93B/HKN-9010/ HKN-2000(30K Ω@25 °C)	TDV-15PS		Pediatric Skin	1.5m		C1.3
	TDV-PS		Pediatric Skin	3.0m		C2
YP-3000/2008/970/930/920/ 910/90AB/90A (30K Ω@25 °C)	TDVA-15PS	88.05.005.00	Pediatric Skin	1.5m		C1.3
	TDVA-PS		Pediatric Skin	3.0m		C2
Infant Incubator: YP-90/90A/90AB/90B/YP-2000 (30K Ω@25 °C)	TDVB-15PS	02 025 00	Pediatric Skin	1.5m		C1.3
	TDVB-PS		Pediatric Skin	3.0m		C2



OEM & Models	Unimed REF#	OEM REF#	Application	Cable Length	Monitor End Plug	Price (unit)
<b>Draeger</b>						
Isolette C2000/8000, Versalet 7700 (8.98K Ω@25 °C)	TDGA-15PS	MU12533	Pediatric Skin	1.5m		C2
	TDGA-PS		Pediatric Skin	3.0m		C3
<b>Draeger &gt; Air Shields</b>						
IICS-90, Globe-Trotter GT5400, C-550 QT, Isolette C100, Isolette C100 QT, Isolette TI 500 Isolette C200, Isolette C450, Isolette C450 QT, Isolette C550, PM78 (6.868K Ω@25 °C)	TAS-15AS		Adult Skin	1.5m		B8
	TAS-15PS	MU06951	Pediatric Skin	1.5m		C1
	TAS-15AG		Adult General	1.5m		B8
	TAS-15PG		Pediatric General	1.5m		C1
	TDGD-15AS		Adult Skin	1.5m		B7
Resuscitaire Birthing Warmer (6.868K Ω@25 °C)	TDGD-AS		Adult Skin	3.0m		B8
	TDGD-15PS	MU11225	Pediatric Skin	1.5m		B7.9
	TDGD-PS		Pediatric Skin	3.0m		B8.1
<b>Draeger &gt; Siemens</b>						
Infinity Delta, Infinity Gamma, Infinity Kappa, Infinity Vista (2.252K Ω@25 °C)	TSM-15AS	4329822	Adult Skin	1.5m		C2
	TSM-AS	5204669		3.0m		C3
	TSM-15PS		Pediatric Skin	1.5m		C3
	TSM-PS			3.0m		C4
	TSM-15AG	4329889	Adult General	1.5m		C2
	TSM-AG	5204644		3.0m		C3
	TSM-15PG	4329848	Pediatric General	1.5m		C3
TSM-PG	5204651	3.0m		C4		
<b>DRE</b>						
Waveline EZ, Waveline Pro, Waveline Touch (2.252K Ω@25 °C)	TDRE-AS		Adult Skin	3.0m		C1.3
	TDRE-PS		Pediatric Skin	3.0m		C2
	TDRE-AG		Adult General	3.0m		C1.3
	TDRE-PG		Pediatric General	3.0m		C2
<b>Edan</b>						
iM20/X8/X10/X12 (2.252K Ω@25 °C)	TEDA-AS	01.15.040226	Adult Skin	3.0m		B7
	TEDA-PS	01.15.040253	Pediatric Skin	3.0m		B8
	TEDA-AG	01.15.040227	Adult General	3.0m		B7
	TEDA-PG	01.15.040254	Pediatric General	3.0m		B8
iM20/X8/X10/X12 (10K Ω@25 °C)	TEDB-AS	01.15.040225	Adult Skin	3.0m		B7
	TEDB-PS	01.15.040255	Pediatric Skin	3.0m		B8
	TEDB-AG	01.15.040228	Adult General	3.0m		B7
	TEDB-PG	01.15.040256	Pediatric General	3.0m		B8
<b>Fisher &amp; Paykel</b>						
MR850 & HC550 Humidifiers	ATP21-FP-869	900MR869	Airway Temperature Probe	2.1m(1.5m)		C8
	ATP11-FP-861	900MR861		1.1m(1.8m)		C8
	ATP21-FP-861	900MR861		2.1m(1.8m)		C8
	ATP09-FP-805	900MR805	Heater Wire Adapter-dual Limb	0.9m		C8
	ATP04-FP-806	900MR806	Heater Wire Adapter-single Limb	0.4m		C8
MR700 & HC500 Humidifiers)	ATP19-FP-561	900MR561	Airway Temperature Probe	1.9m(1.8m)		C8
	ATP-FP-560	900MR560		(1.3m)		C8
<b>GE-Datex Ohmeda</b>						
2001/3000/3400/13500/4000 IWS, Care Plus 1000/2000 (3.5mm Mono Plug) (10K Ω@25 °C)	T3510-AS		Adult Skin	3.0m		B7
	T3510-PS	6600-0628-700	Pediatric Skin	3.0m		B8
	T3510-AG		Adult General	3.0m		B7
	T3510-PG		Pediatric General	3.0m		B8
Giraffe Infant Warmer, Omnibed, Panda Infant Warmers (10K Ω@25 °C)	TOH-AS		Adult Skin	1.5m		C3.8
	TOH-PS	6600-0875-700/2075796-001	Pediatric Skin	3.0m		C3.8
<b>GE-Marquette</b>						
Dash, E-PRESTN, Eagle, MAC-Lab, PDM Module, SOLAR, Tram, Tram 451, Carescape B650 (2.252K Ω@25 °C)	TMQ-AS		Adult Skin	3.0m		C2
	TMQ-PS		Pediatric Skin	3.0m		C3
	TMQ-AG		Adult General	3.0m		C2
	TMQ-PG		Pediatric General	3.0m		C3
	TMQ2-AS	(Dual Temp.)	Adult Skin *2	3.0m		C7
	TMQ-AS/AG	(Dual Temp.)	Adult Skin+Adult General	3.0m		C7

OEM & Models	Unimed REF#	OEM REF#	Application	Cable Length	Monitor End Plug	Price (unit)
<b>Mindray &gt; Datascope</b>						
BeneView T1/T1/T5/T8, DPM6, DPM7, Passport 12, Passport 8, iMEC Series, iPM Series, iPM-9800 (2.252K Ω@25 °C)	TMR-AS	0011-30-37393	Adult Skin	3.0m		C1.3
	TMR-PS	0011-30-37395	Pediatric Skin	3.0m		C2
	TMR-AG	0011-30-37392	Adult General	3.0m		C1.3
	TMR-PG	0011-30-37394	Pediatric General	3.0m		C2
	TDT-AS	040-000057-00	Adult Skin	3.0m		C1.3
Passport V, V-Series (2.252K Ω@25 °C)	TDT-PS	040-000058-00	Pediatric Skin	3.0m		C2
	TDT-AG	040-000055-00	Adult General	3.0m		C1.3
	TDT-PG	040-000056-00	Pediatric General	3.0m		C2
<b>Philips</b>						
IntelliVue MMS X2, IntelliVue MP2, IntelliVue MX400, IntelliVue MX800, M1029A, M3001A (2.252K Ω@25 °C)	THP-AS	21078A/989803100901	Adult Skin	3.0m		C2
	THP-PS		Pediatric Skin	3.0m		C3
	THP-AG	21075A/989803100881	Adult General	3.0m		C2
	THP-PG	21076A	Pediatric General	3.0m		C3
<b>Spacelabs</b>						
90369, Ultraview (2.252K Ω@25 °C)	TSL-AS		Adult Skin	3.0m		C5
	TSL-PS		Pediatric Skin	3.0m		C6
	TSL-AG		Adult General	3.0m		C5
	TSL-PG		Pediatric General	3.0m		C6
	TSL2-AS	(Dual Temp.)	Adult Skin *2	3.0m		C8.1
	TSL-AS/AG	(Dual Temp.)	Adult Skin+Adult General	3.0m		C8.1
<b>YSI 400</b>						
400 Series (6.3mm Mono Plug) (2.252K Ω@25 °C)	T2252-AS	409B	Adult Skin	3.0m		B7
	T2252-PS	429	Pediatric Skin	3.0m		B8
	T2252-AG	401	Adult General	3.0m		B7
	T2252-PG	402	Pediatric General	3.0m		B8
(3.5mm Mono Plug) (2.252K Ω@25 °C)	T35-AS		Adult Skin	3.0m		B8.1
	T35-PS		Pediatric Skin	3.0m		C1.3
	T35-AG		Adult General	3.0m		B8.1
	T35-PG		Pediatric General	3.0m		C1.3
<b>YSI 700</b>						
700 Series (6.3mm Mono Stereo Plug) (30K Ω@25 °C & 6K Ω@25 °C)	T700-AS	709B	Adult Skin	3.0m		C2
	T700-PS	729	Pediatric Skin	3.0m		C3
	T700-AG	701	Adult General	3.0m		C2
	T700-PG	702	Pediatric General	3.0m		C3
<b>YSI 10K</b>						
(6.3mm Mono Plug) (10K Ω@25 °C)	T10-AS		Adult Skin	3.0m		B6.7
	T10-PS		Pediatric Skin	3.0m		B7
	T10-AG		Adult General	3.0m		B6.7
	T10-PG		Pediatric General	3.0m		B7

Unimed REF#	Descriptions & Application	PCS /Per box	Price (box)
T004-16	Disposable temperature probe cover Used with reusable skin temp. probe to fixed the probe onto the skin and reflect the ambient light to ensure the accurate measurement	16	A8



The probe cover package not includes the reusable probe. Separated order required.



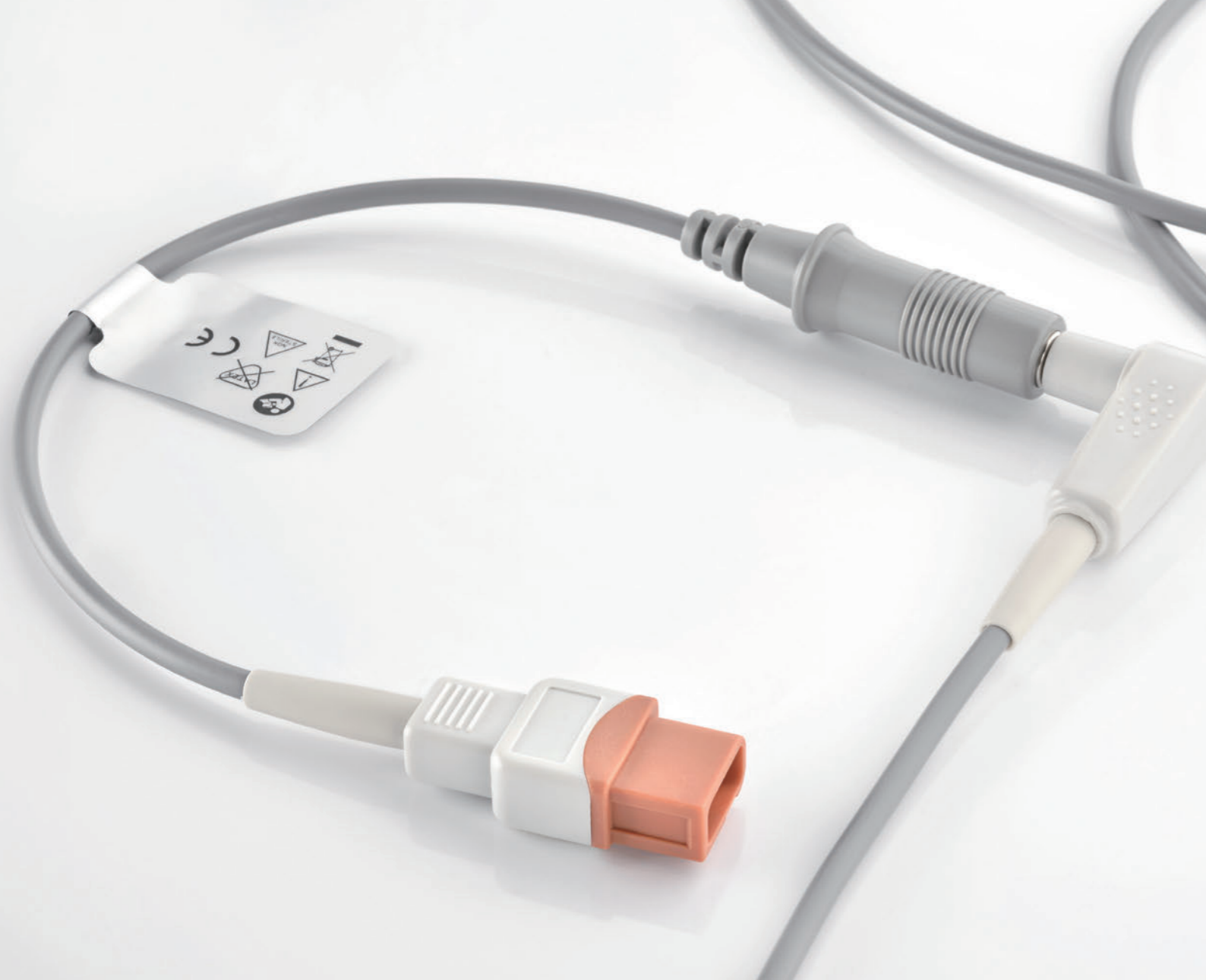

## 1.2 Temp. Adapter Cable for Reusable Probe

### Reference Number Rule Description

TSM-AD/2	
T	Temperature probe
SM	Factory/model (See other on previous page)
2	2 channel(Default is single channel)
AD	Adapter, used with reusable YSI probes

OEM & Models	Unimed REF#	Application	Cable Length	Monitor End Plug	Probe End Connector	Price
<b>Artema-S&amp;W</b>						
	<b>TSM-AD</b>	Used with reusable YSI400 compatible probes	0.3m			B7.9
<b>Biolight</b>						
AnyView A2/A3/A5/A6/A8 V6 Vital Sign	<b>TBLT-AD</b>	Used with reusable YSI400 compatible probes	0.3m			B7.9
<b>Comen</b>						
C100,C90,C70,C60,C50, C30,C20,NC8,NC10,NC12	<b>TCM-AD</b>	Used with reusable YSI400 compatible probes	0.3m			B7.9
<b>Draeger &gt; Siemens</b>						
Infinity Delta, Infinity Gamma, Infinity Kappa, Infinity Vista	<b>TSM-AD</b> (5198333)	Used with reusable YSI400 compatible probes	0.3m			B8
<b>Edan</b>						
iM20/X8/X10/X12	<b>TED-AD</b>	Used with reusable YSI400 compatible probes	0.3m			B7
<b>Fukuda Denshi</b>						
DS-8100/DS-8200/ DS-8400/DS-8500/ DS-8700	<b>TFD-40-AD/2</b> (CJO-P01T-DA4.0/ 550215710)	Used with reusable YSI400 compatible probes	4.0m			C8.3
<b>GE Marquette</b>						
	<b>TMQ-AD</b>	Used with reusable YSI400 compatible probes	0.3m			B8
Dash, E-PRESTN, Eagle, MAC-Lab, PDM Module, SOLAR, Tram, Tram 451, Carescape B650	<b>TMQ400-AD/2</b> (2016998-001)	Used with reusable YSI400 compatible probes	0.3m			C4
	<b>TMQ700-AD/2</b> (402015-004)	Used with reusable YSI700 compatible probes	0.3m			C4
<b>Mindray &gt; Datascope</b>						
BeneView T1/T1/T5/T8, DPM6, DPM7, Passport 12, Passport 8, iMEC Series, iPM Series, iPM-9800	<b>TMR-AD</b>	Used with reusable YSI400 compatible probes	0.3m			B7.9
Passport V, V-Series	<b>TDT-AD</b>	Used with reusable YSI400 compatible probes	0.3m			B7.9

OEM & Models	Unimed REF#	Application	Cable Length	Monitor End Plug	Probe End Connector	Price
<b>Nihon Kohden</b>						
BSM-5100/6000/9100 TEC-8300	<b>TNK-045-AD/2</b> (K961/JT-900P)	Used with reusable YSI400 compatible probes	0.45m			C5
<b>Philips</b>						
IntelliVue MMS X2/MP2/ MX400MX800, M1029A, M3001A	<b>THP-AD</b> (989803163281)	Used with reusable YSI400 compatible probes	0.3m			B8
<b>Spacelabs</b>						
90369, Ultraview	<b>TSL-AD</b>	Used with reusable YSI400 compatible probes	0.3m			C4
Command Modules 90496/91496, DM3 Monitor 91330 and mCare Monitor 91220	<b>TSL-AD/2</b> (700-0031-00)	Used with reusable YSI400 compatible probes	0.3m			C8

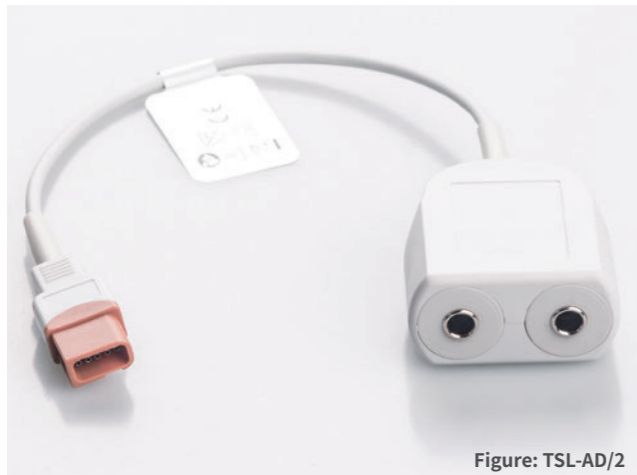

Figure: TSL-AD/2



Figure: TMQ-AD

## 2 Disposable Temp. Probe

### Compatible with Major Patient Monitor Brands

- |                |                       |
|----------------|-----------------------|
| Air Shield(AS) | Mindray-Datascope(DT) |
| Drager(DG)     | Philips(HP,PM)        |
| Marquette(MQ)  | YSI400(YSI)           |
| Mindray(MR)    | Ohmeda(OH)            |

### Features

- Single patient use
- Use in esophagus/rectum/nasopharynx/axilla, skin, ear, bladder
- Accurate measurement
- Quick response
- Low noise signal transfer
- Fully compatible with OEM technology

### Specification

<b>Probe type</b>	Esophagus/rectum/nasopharynx/axilla, skin, ear, bladder
<b>Cable Length</b>	0.75m/0.9m/3.0m; unless requirement applied
<b>Resister type</b>	NTC/YSI400/2.252K@25°C
<b>Cable Material</b>	PVC jacket ,white
<b>Connector</b>	Golden plated pins

## 2.1 Disposable Skin, Esophageal/Rectal Temp. Probe

### Reference Number Rule Description

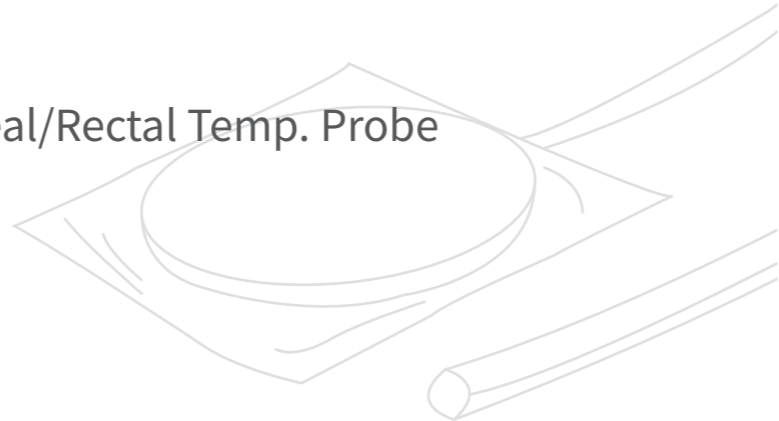

TMQ-DAG-20	
T	Temperature probe
MQ	Factory/model (See left)
D	Disposable Probe
A	Adult(P= Pediatric)
G	General purpose (S=Skin)
20	20 pcs per box (10=10pcs/box)

OEM Technology	REF#	OEM REF#	Application	Cable Length	Probe Adapter	Adapter cable	Package	Price (box)
Artema/S&W	TSW30-D-10		Skin	300cm		Direct	10pcs/box	D5
	TSW30-DAG-10		General	300cm		Direct	10pcs/box	D5
Atom V-2100, V-2100G, V-2200, V-505, V-505ST, V-80, V-800	TAT30-D-10		Skin	300cm		Direct	10pcs/box	D5
	TAT30-DAG-10		General	300cm		Direct	10pcs/box	D5
Beijing Julongsanyou BNT-1000/BNT-2000/ BNT-2000B	T2015-D-10		Skin	150cm		Direct	10pcs/box	D3.4
	T2015-DAG-10		General	150cm		Direct	10pcs/box	D3.4
Beijing Julongsanyou B-800/B-1000/B-2000/ B-3000	TBNT15-D-10		Skin	150cm		Direct	10pcs/box	D3.4
	TBNT15-DAG-10		General	150cm		Direct	10pcs/box	D3.4
Biolight AnyView A2/A3/A5/A6/A8 V6 Vital Sign	TBLT30-D-10		Skin	300cm		Direct	10pcs/box	D4
	TBLT30-DAG-10		General	300cm		Direct	10pcs/box	D4
Draeger Isolette C2000/8000, Versalet 7700	TDGA10-DPS-10	MU12551	Mini Skin	100cm		Direct	10pcs/box	D5.09
Draeger Caleo, Babytherm TN500/ 8000WB/8004/8010	TDG-D-20		Skin	76cm		Direct	20pcs/box	D5
	TDG-DAG-20		General	76cm			10pcs/box	D3.8
	TDG15-DPS-10	MX11000	Mini Skin	150cm				
	TDGC15-DPS-10	MX11001	Mini Skin	150cm				
Draeger > Air Shields C-550 QT, Isolette C100/ C100 QT/C200/C450/ C450 QT/C550/PM78	TAS30-D-10		Skin	300cm		Direct	10pcs/box	D3.4
	TAS30-DAG-10		General	300cm				
Draeger > Siemens Infinity Delta, Infinity Gamma, Infinity Kappa, Infinity Vista	TSM16-D-10	MP00995/MP00997	Skin	160cm		Direct	10pcs/box	D4
	TSM30-D-10	MP00996/MP00998	Skin	300cm				
	TSM16-DAG-10	MP00991	General	160cm				
	TSM30-DAG-10	MP00992	General	300cm				
GE YSI 400 Series	TMQ-D-20	8001642/M1024222	Skin	76cm		TMQ-30-AD	20pcs/box	D5
	TMQ-DAG-20	8001644/M1024229	General	76cm				
GE-Datex Ohmeda Giraffe,OmniBed, Panda iRes	TOH30-D-10	6600-0873-700 6600-0874-700	Skin	300cm		Direct	10pcs/box	D5
	TOH30-DAG-10		General	300cm				
GE-Datex Ohmeda 2001/3300/3500 IWS (10K Ω)	T3510-D-20	LA003/LA005	Skin	76cm		THP-30-D	20pcs/box	D6.6
	T3510-DAG-20		General	76cm				
Mindray BeneView T1/T1/T5/T8	TMR30-D-10		Skin	300cm		Direct	10pcs/box	D4
	TMR30-DAG-10		General	300cm				
Mindray > Datascope Passport V, V-Series	TDT30-D-10		Skin	300cm		Direct	10pcs/box	D4
	TDT30-DAG-10		General	300cm				
Philips YSI 400 Series	THP-D-20		Skin	76cm		THP-30-D	20pcs/box	D4
	THP-DAG-20		General	76cm				
Philips IntelliVue MX800, M1029A, M3001A	TPM30-D-10		Skin	300cm		Direct	10pcs/box	D4
	TPM30-DAG-10		General	300cm				
Spacelabs 90369, Ultraview	TSL30-D-10		Skin	300cm		Direct	10pcs/box	D6.7
	TSL30-DAG-10		General	300cm				
YSI 400	TYSI30-D-10		Skin	300cm		Direct	10pcs/box	D4
	TYSI30-DAG-10		General	300cm				

## 2.2 Disposable Tympanic Temp. Probe

### Specification

- Monitoring the tympanic membrane temperature in the ear canal, well correlates the core body temperature.
- Dual foam protection with soft memory cell foam to minimize the risk of injury to the tympanic membrane, and seal out the ambient air.
- PVC push tube makes insertion and pulling easily, and protects the lead wire from kink and break.
- Thinner lead wire is more pliable and provide accurate temperature readings.

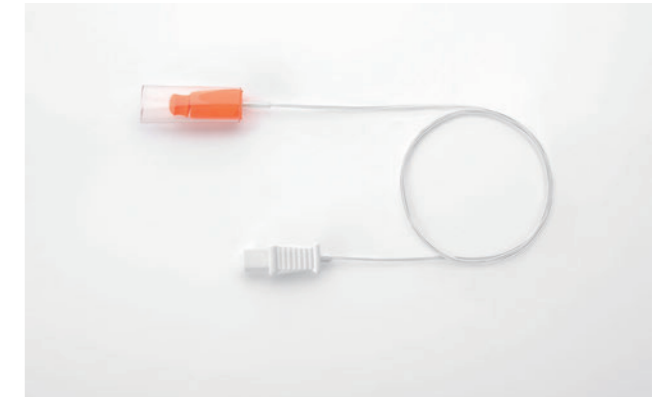

OEM Technology	REF#	OEM REF#	Application	Probe End Connector	Adapter Cable	Package	Price (unit)
YSI 400 Series	TMQ-PE		Pediatric tympanic temperature probe		See the next page of adapter cable	1pc/bag	B3
	TMQ-AE		Adult tympanic temperature probe				

## 2.3 Foley Catheter Temp. Probe

### Specification

- Monitoring the bladder temperature during urinary drainage
- Commonly used to monitor core body temperature during open-heart surgery or critically ill patients
- Provides accurate temperature readings
- Silicone construction and latex-free prevent irritation and sensitive reaction.
- Water-proof design avoided liquid seepage



OEM Technology	REF#	OEM REF#	Application	Probe End Connector	Adapter Cable	Package	Price (unit)
YSI 400 Series	T2P14N-DG		Adult foley catheters temperature probe,14fr		See the next page of adapter cable	1pc/bag	B8.1
	T2P16N-DG		Adult foley catheters temperature probe,16fr				
	T2P18N-DG		Adult foley catheters temperature probe,18fr				



## 2.4 Disposable Esophageal Stethoscope Temp. Probe

### Specification

- Monitoring the temperature in the esophagus
- Anesthesiologist can hear the heart and lung sounds through the ear piece while monitoring the temperature.
- Acoustic balloon design to enhance sound quality
- Smooth, heat-bonded cuff to tube transition minimizes potential trauma and irritation
- Can use with esophageal stethoscope(Optionally)



OEM Technology	REF#	OEM REF#	Application	Probe End Connector	Adapter Cable	Package	Price (unit)
YSI 400 Series	T2P9ST-DG		Pediatric esophageal stethoscope Temperature probe , 9fr , with ear piece		See the next page of adapter cable	1pc/bag	B7.9
	T2P12ST-DG		Adult esophageal stethoscope Temperature probe , 12fr , with ear piece				
	T2P18ST-DG		Adult esophageal stethoscope Temperature probe , 18fr , with ear piece				
	T2P24ST-DG		Adult esophageal stethoscope Temperature probe , 24fr , with ear piece				

## 2.4a Accessories

### Stethoscope Ear Piece

### Specification

- Use with disposable esophageal stethoscope temp probe
- Connect ear piece extension tubing to the stethoscope luer connector for listening to heart and lung sounds.
- Acoustical design to get the good sound quality





























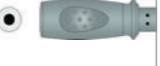



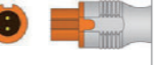





OEM Technology	REF#	OEM REF#	Application	Probe End Connector	Adapter Cable	Package	Price (unit)
YSI 400 Series	TSTP-EP		Stethoscope	N/A	N/A	1pc/bag	A3



## 2.5 Temp. Adapter Cable for Disposable Probe

### Reference Number Rule Description

THP-30-AD	
T	Temperature adapter cable
HP	Factory/model (see others on the previous page)
30	3.0m cable length
AD	Used with YSI 400 series disposable probe(ph: philips disposable probe)

OEM & Models	Probe end Conn	UNIMED REF#	Probe end Conn	UNIMED REF#	Cable Length	Monitor End Plug	Price (unit)
	For 400 Disposable		For Philips Disposable				
<b>Artema-S&amp;W</b>							
		<b>TSW-30-AD</b>		<b>TSW-30-PH</b>	3.0m		C1
<b>Biolight</b>							
AnyView A2/A3/ A5/A6/A8 V6 Vital Sign		<b>TBLT-30-AD</b>		<b>TBLT-30-PH</b>	3.0m		C1
<b>Comen</b>							
C100,C90,C70, C60,C50,C30,C20, NC8,NC10,NC12		<b>TCM-30-AD</b>		<b>TCM-30-PH</b>	3.0m		C1
<b>Draeger &gt; Siemens</b>							
Babytherm 8004, 8010		<b>TSM-30-AD</b>		<b>TSM-30-PH</b>	3.0m		C1.3
<b>Edan</b>							
iM20/X8/X10/X12		<b>TED-30-AD</b>		<b>TED-30-PH</b>	3.0m		B8.1
<b>GE-Marquette</b>							
Dash, Tram, Tram 451, Carescape B650		<b>TMQ-30-AD</b> (2021701-001)		<b>TMQ-30-PH</b>	3.0m		C1.3
<b>Mindray &gt; Datascope</b>							
BeneView T1/T1/ T5/T8, DPM6, DPM7, Passport 12, Passport 8		<b>TMR-30-AD</b> (040-001235-00/MR420B)		<b>TMR-30-PH</b> (0011-30-90444) (0011-30-37391)	3.0m		C1
Passport V, V-Series		<b>TDT-30-AD</b> (040-000091-00)		<b>TDT-30-PH</b>	3.0m		C1
<b>Philips</b>							
IntelliVue MX800, M1029A, M3001A		<b>THP-30-AD</b>		<b>THP-30-PH</b> (989803100921/21082A) (989803100931/21082B)	3.0m		C1.3
<b>Spacelabs</b>							
Modules 90496/91496, DM3 Monitor 91330 and mCare Monitor 91220		<b>TSL-30-AD</b>		<b>TSL-30-PH</b>	3.0m		C5
<b>YSI 400</b>							
400 Series (6.3mm Mono Plug)		<b>YYSI-30-AD</b> (165640/165641) (9445-801)		<b>YYSI-30-PH</b> (989803162591/ 989803162601)	3.0m		C1.3
400 Series (6.3mm Mono Straight Plug)		<b>YYSI-30S-AD</b> (Spacelabs: 700-4000-00)		<b>YYSI-30S-PH</b>	3.0m		C1.3



### 3 Smart Temp. Probe

#### Compatible with Major Patient Monitor Brands

Major brands temperature monitoring system

#### Features

- Accurate measurement
- 15s Quick response
- Low noise signal transfer
- Fully compatible with OEM technology
- 12 month warranty

#### Specification

Probe type	Oral;Rectal
Cable Length	4m unless requirement applied
Resister type	NTC
Cable material	TPU jacket,Light gray
Package	1pc per bag

### 3.1 Smart Temp. Probe

#### Reference Number Rule Description

TOP-AR-001	
T	Temperature
O	Oral (Rectal)
P	Probe
AR	Factory Code (AR=Alaris,GE=GE Healthcare,MR=Mindray)
001	Factory /model



OEM & Models	Unimed REF#	OEM REF#	Application	Cable Length	Monitor end plug	Price (unit)		
<b>Alaris</b>								
VITAL CHECK 4400/4410/4500 2080D	TOP-AR-001	3880L	Oral	1.2m		C8.1		
	TRP-AR-001	3882L	Rectal	1.2m				
Turbo Temp 2180C/2180CX01EE	TOP-AR-002	2885C	Oral	1.2m				
	TRP-AR-002	2886C	Rectal	1.2m				
Turbo Temp 2185B/2185BX01EE	TOP-AR-003	2887B	Oral	1.2m				
	TRP-AR-003	2888B	Rectal	1.2m				
<b>GE Healthcare</b>								
Dinamap Pro100 Dinamap 200 Dinamap 400 V1	TOP-AR-001	088012	Oral	1.2m		C8.1		
	TRP-AR-001	088016	Rectal	1.2m				
Dinamap V100/Pro 200 V2/ Pro 400 V2/Pro 1000/ ProCare200/ProCare 400/ ProCare 220DPC/ ProCare DPC400N	TOP-AR-002	2008774-001	Oral	1.2m				
	TRP-AR-002	2008775-001	Rectal	1.2m				
DINAMAP 9300 Series DINAMAP XL	TOP-GE-001	008975 008978	Oral	1.2m				C8.1
	TRP-GE-001	008976	Rectal	1.2m				
<b>Mindray</b>								
Accutorr Plus	TOP-MR-001	0206-00-0725-01	Oral	1.2m		C8.1		
	TRP-MR-001	0206-00-0725-02	Rectal	1.2m				
<b>Welch Allyn</b>								
SureTemp Plus 690 SureTemp Plus 692 Spot vital signs LXi Series Vital Signs Monitor 300 Series Connex Vital Signs Monitor 6000Series	TOP-WA-002	See Next Table	Oral	1.2m		C8.1		
	TOP-WA-002L			2.5m		C8.3		
	TOP-WA-002XL			3.0m		C8		
	TOP-WA-003 <sup>New</sup>		1.2m	D1				
	TRP-WA-002		1.2m	C8.1				
	TRP-WA-002L		2.5m	C8.3				
TRP-WA-002XL	3.0m	C8						
<b>Welch Allyn SureTemp Plus Probe Well</b>								
SureTemp Plus 690 Veterinary SureTemp Plus 692 SureTemp Plus 690	Y13-M054	02891-0000	Oral(Blue)	/		B1		
	Y13-M055	02891-1000	Rectal(Red)	/				
Spot Vital Signs 4400 Device Spot Vital Signs LXi Device Vital Signs Monitor 300 Series	Y13-M056	02894-0000	Oral(Blue)	/		A8		
	Y13-M057	02894-1000	Rectal(Red)	/				
<b>Welch Allyn SureTemp Plus Probe Well Kit</b>								
OEM REF#	Unimed REF#	OEM REF#	Unimed REF#	Price(unit)				
02893-000 (1.2m)	TOP-WA-002/A (TOP-WA-002+Y13-M054)	02892-000 (1.2m)	TRP-WA-002/A (TRP-WA-002+Y13-M055)	C8.8				
02893-100 (2.7m)	TOP-WA-002L/A (TOP-WA-002L+Y13-M054)	02892-100 (2.7m)	TRP-WA-002L/A (TRP-WA-002L+Y13-M055)	D1				
02895-000 (2.7m)	TOP-WA-002L/B (TOP-WA-002L+Y13-M056)	02895-100 (2.7m)	TRP-WA-002L/B (TRP-WA-002L+Y13-M057)	C8.9				

## Original Brands Medical Devices

#### Welchallyn



Fiber Optic Laryngoscope



Otosopes



Ophthalmoscope

#### Pulse Oximeter



PULSE OXIMETER



Wrist Oximeter



Fingertip Oximeter

#### Original monitoring accessories



Philips Medical



GE Healthcare



Covidien



Masimo

#### Compatible Fetal Transducer



US/TOCO Transducer

Compatible with major brands

#### Medical Oxygen Sensor



Oxygen Sensor & Analyzer

Compatible with major brands

• For detail information of the above devices like specifications prices and availabilities please contact Unimed sales representatives



## Fetal Transducer & Accessories

- 1. Fetal Transducers ..... 261
- 2. Accessories ..... 265
- 3. DECG Reusable Legplate Adapter Cable ..... 267

















Unimed Toco & ultrasound transducers are compatible for all major fetal monitors brands.







# 1 Fetal Transducers

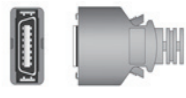

Manufacturer & Models	OEM REF#	Transducer Type#	Monitor End Plug	REF#	Price
<b>Philips</b>					
Model M1350, M1351A, Series 50, Series 50A	M1356A	Ultrasound Transducer		UFU200-20	D8
	M1355A	Toco Transducer		UFT200-10	D8
8040A, 8041A	15245A	Ultrasound Transducer		UFU200-10	D8
<b>GE Healthcare</b>					
Corometrics116,118,120,129, 150,151,155,170,171, 173, 250,340, ...	5700LAX	Ultrasound Transducer		UFU300-10	D8
	5700HAX	Ultrasound Transducer		UFU300-20	D8
	2264LAX	Toco Transducer		UFT300-10	D8
	2264HAX	Toco Transducer		UFT300-20	D8
<b>Spacelabs/AMS</b>					
AM66, IM76	US91, AMS-20-0011	Ultrasound Transducer		UFU500-20	D8

Manufacturer & Models	OEM REF#	Transducer Type#	Monitor End Plug	REF#	Price
<b>Analogic</b>					
Fetalgard Lite	U/S1	Ultrasound Transducer		UFU600-10	D8
	TOCO-B-6	Toco Transducer		UFT600-10	D8
<b>Sonicaid Oxford/Huntleigh</b>					
Sonicaid Team, Sonicaid Team Duo (1.0MHz, Green)	ACC-OBS-008, ACC-OBS-008L	Ultrasound Transducer		UFU700-10	E3.6
Sonicaid Team, Sonicaid Team Duo (1.5MHz, Yellow)	8400-6919, 8400-6919L	Ultrasound Transducer		UFU700-20	E3.6
Sonicaid Team, Sonicaid Team Duo (2.0MHz, Blue)	8400-6920, 8400-6920L	Ultrasound Transducer		UFU700-30	E3.6
Sonicaid Team, Sonicaid Team Duo, Sonicaid FM800 series, Sonicaid Team3	ACC-OBS-009, ACC-OBS-009L 8400-6921, 8400-6921L	Toco Transducer		UFT700-10	E3.6
sonicaid BD4000xs	CT1	Ultrasound Transducer		UFU902-10	D8.3.1
	US1	Toco Transducer		UFT902-10	E1
<b>Sunray</b>					
SRF618A		Ultrasound Transducer		UFU800-10	D7
		Toco Transducer		UFT800-10	D6.6.5
		Ultrasound&Toco Transducer(2in1)		UF800-10	E3
<b>Edan</b>					
F2, F3, F6, F9	MS3-109301(D)(PINK)	Ultrasound Transducer		UFU801-10	D7
		Ultrasound Transducer		UFU801-20	D7
	MS3-109301016	Ultrasound Transducer		UFU801-30	D7
	MS3-31527(B)	Toco Transducer		UFT801-10	D6.6.5
	MS3-210260	Toco Transducer		UFT801-20	D6.6.5

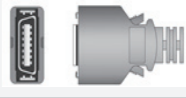
Manufacturer & Models	OEM REF#	Transducer Type#	Monitor End Plug	REF#	Price
<b>Goldway</b>					
CTG7		Ultrasound Transducer		UFU803-10	D7
		Toco Transducer		UFT803-10	D6.6.5
<b>Biocare</b>					
FM-801X		Ultrasound Transducer		UFU805-10	D7
		Toco Transducer		UFT805-10	D7
IC60		TOCO FHR Fetal Movement Probe(3in1)		UF805-10	E3.6
		TOCO FHR Fetal Movement Probe(3in1)		UF805-20	E3.6
<b>Comen</b>					
STAR-5000C		Ultrasound Transducer		UFU804-10	D7
STAR-5000E		Ultrasound Transducer		UFU804-20	D7
C11/C21/C22		Ultrasound Transducer		UFU804-30	D7
STAR-5000C		Toco Transducer		UFT804-10	D6.6.5
STAR-5000E		Toco Transducer		UFT804-20	D6.6.5
C11/C21/C22		Toco Transducer		UFT804-30	D6.6.5
STAR-5000, STAR-5000A		TOCO FHR Fetal Movement Probe(3in1)		UF804-10	E3.6
		TOCO FHR Fetal Movement Probe(3in1)		UF804-20	E3.6
<b>Bistos</b>					
		Ultrasound Transducer		UFU900-10	D7
BT-350/330/300		Ultrasound Transducer		UFU900-20	D7
		Toco Transducer		UFT900-10	E1
BT-350/330/300		Toco Transducer		UFT900-20	E1

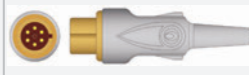
Manufacturer & Models	OEM REF#	Transducer Type#	Monitor End Plug	REF#	Price
<b>Econet/Bionet</b>					
FC700		Ultrasound Transducer		UFU901-10	E1
FC1400		Ultrasound Transducer		UFU901-20	E1
		Ultrasound Transducer		UFU901-30	E1
FC700		TOCO Transducer		UFT901-10	E1
FC1400		TOCO Transducer		UFT901-20	E1
		TOCO Transducer		UFT901-30	E1
<b>Bionics</b>					
☆ BPM-900		Ultrasound Transducer		UFU903-10	E1.8.5
☆ BPM-900		TOCO Transducer		UFT903-10	E1.8.5



## 2 Accessories







Photo	REF#	Descriptions	Compatibility	Package	Price	No. in Pictures
	UREM-008	Fetal monitor event marker 3.0m length Biocare 4-pin 40° keyed lemo	Biocare	1pc/bag	C8	G
	E043-08	Reusable transducer belt With holes and button lock 35(W)X1300(L)mm Light blue	For all fetal transducer with proper sizes	8pcs/bag	C4	H
	E044-08	Reusable transducer belt With holes and button lock 60(W)X1300(L)mm Blue		8pcs/bag	C8.1	I

Photo	REF#	Descriptions	Compatibility	Package	Price	No. in Pictures
	UREM-001	Event mark cord 3.0m length 3.5mm jack plug	Philips medical/HP GE Corometrics Spacelabs	1pc/bag	C4	A
	UREM-002	Event mark cord 3.0m length Philips 8 pin-switch	Philips Avalon FM20/FM30	1pc/bag	C8	B
	UREM-004	Fetal monitor event marker 3.0m length Sunray 2-pin 40° keyed lemo	Sunray	1pc/bag	C8	C
	UREM-005	Fetal monitor event marker 3.0m length Goldway 6-pin lemo	Goldway	1pc/bag	C8	D
	UREM-006	Fetal monitor event marker 3.0m length Comen 2-pin lemo	Comen	1pc/bag	C8	E
	UREM-007	Fetal monitor event marker 3.0m length Comen 7-pin lemo	Comen	1pc/bag	C8	F

### 3 DECG Reusable Legplate Adapter Cable



DECG Reusable Legplate Adapter Cable (shown with Fetal Spiral Electrode and Attachment Electrode)

Manufacturer & Models	OEM REF#	use with	Product Photo	Unimed REF#	Price
Philips M2703A, M2705A, M1350A, M1350B, M1350C, M1353A, M1357A, M1364-60001, M2738A, M1365A, M2727A, M2735A, M2720A	989803137651	philips 989803137631 & 989803137641 fetal spiral electrodes		AD-UFT-001	D3.4
GE-Corometrics 120, 126, 128, 129	989803137801	philips 989803137631 & 989803137641 fetal spiral electrodes		AD-UFT-002	D3.4

Manufacturer & Models	OEM REF#	use with	Product Photo	Unimed REF#	Price
GE-Corometrics 115, 116, 118, 119, 173, 174; 120, 126, 128, 129, 250 using a GE Corometrics Y-adapter cable 1442AAO or socket adapter 1442BAO.	989803137791	philips 989803137631 & 989803137641 fetal spiral electrodes		AD-UFT-003	D3.4
GE-Corometrics Monitors with round connector	31479812/FCB 400	Kendall fetal spiral electrode		AD-UFT-004	DD1.3

### 4 Intrauterine Pressure(IUP) Cable

Manufacturer & Models	OEM REF#	use with	Product Photo	Unimed REF#	Price
Philips-Koala Philips Patient module: M2738A; TOCO+ transducer: M2735A; Fetal monitor: M2703A, M2705A	989803143931, IPC-5080	M1333A (Koala disposable IUP catheters)		OT-059	D1.5



Description	Unimed REF#	Sensor Picture	Compatibility	Connector	Price
External Sidestream ETCO <sub>2</sub> Sensor  (Automatic zero function, no needing manual zero for any time.)	<b>UECO<sub>2</sub>-001S</b>		Phase in (ISA AX+)		F5.9
	<b>UECO<sub>2</sub>-002S</b> <small>(M2741A, 989803144591)</small>		Philips (M3014A)		F5.9
	<b>UECO<sub>2</sub>-003S</b> <small>(1022054)</small>		Respironics (C5)		F5
	<b>UECO<sub>2</sub>-005S</b>		Mindray(T5, T8)		F5.9
Mainstream ETCO <sub>2</sub> Sensor  (with one set of standard accessories)	<b>UMCO<sub>2</sub>-001S</b>		Phase in (IRMA CO <sub>2</sub> )		F5.9
	<b>UMCO<sub>2</sub>-002S</b> <small>(M2501A, 989803142651)</small>		Philips(M3014A)		F5.9
	<b>UMCO<sub>2</sub>-003S</b> <small>(1015928)</small>		Respironics (C5)		F5
	<b>UMCO<sub>2</sub>-005S</b> <small>(6800-30-50760)</small>		Mindray (T5,T8)		F5.9

### Accessories

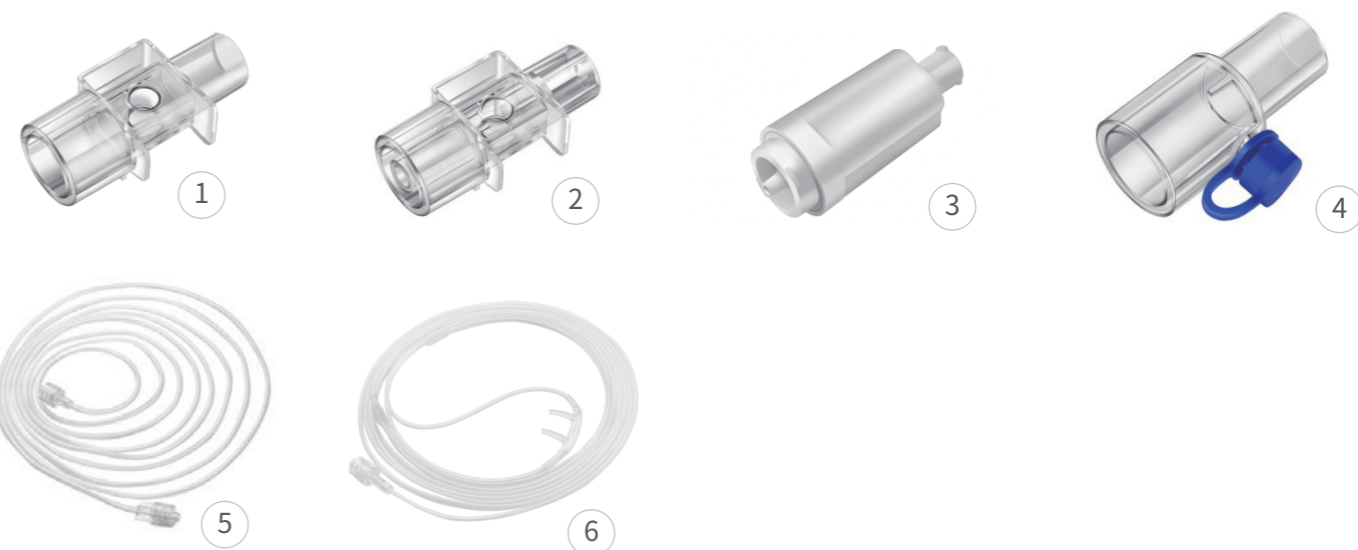

## ETCO<sub>2</sub> Sensor

Unimed offers both Mainstream ETCO<sub>2</sub> Sensor and External Sidestream ETCO<sub>2</sub> Sensor which are the supplement of the host device without the internal ETCO<sub>2</sub> module, they are compatible with most of the major machines in market. Our sensors with high performance, accurate measurement and long service life, are also easy to operate and plug-in-measure and with good design.

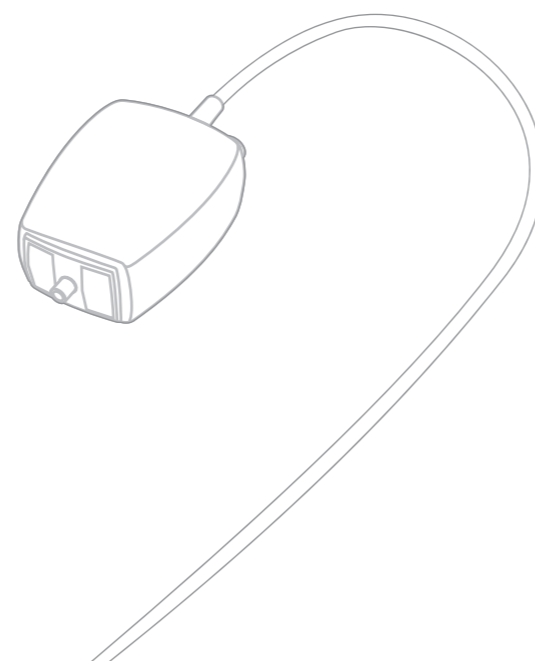

Type	REF#	Descriptions	Price&Package	No. in Pictures
Accessories of Mainstream sensor (Applicable to UMCO <sub>2</sub> -00*S)	663501	Disposable Airway Adaptor (Adult and Pediatric)	B5/pc/bag	①
	663502	Disposable Airway Adaptor (Pediatric and Neonate)	B5.3/pc/bag	②
Accessories of Sidestream sensor (Applicable to UECO <sub>2</sub> -00*S)	664522	Filter	A6/pc/bag	③
	662532	T shape airway adapter	A3/pc/bag	④
	662503	Disposable Extension Sampling Tube	A3/pc/bag	⑤
	662504	Disposable Nasal Gas Sampling Cannula	A7/pc/bag	⑥





## Multi-Parameter Patient Cable

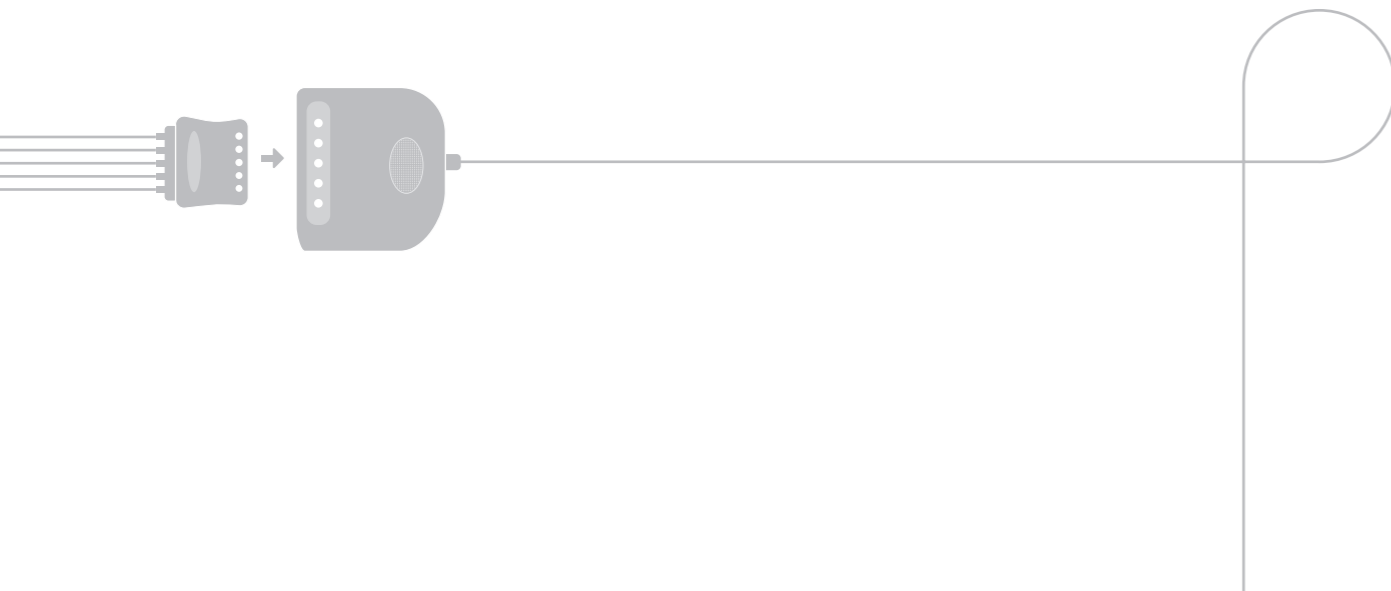

Unimed REF# OEM REF#	OEM Manufacturer & Models	Descriptions	Monitor End Plug	Probe End Connector	Price (unit)
<b>SM-STE5</b>					
3368391, 5950196	Draeger Infinity C500, Infinity C700, Infinity Delta, Infinity Delta XL, Infinity Gamma, Infinity Gamma X, Infinity Gamma XL, Infinity Kappa, Infinity Kappa XLT, Infinity Omega S, Infinity Vista, Infinity Vista XL, SC 6000, SC 7000, SC 9000	<b>MultiMed 5 pod patient cable</b> Use with: (Unimed Products) Such as: Temp: TSM-* (Page 245) ECG 5-lead: SM5-90* Series (Page 25) SpO2: U708-23 (Page 170)		 TEMP./ECG/SPO <sub>2</sub>	D6.5
<b>SM15-STE5</b>					
5950192 (1.5 meter cable)					D6.4
<b>SM-STE6</b>					
5191221	Infinity Gamma, Gamma XL, Gamma X XL, Delta, Delta XL, Kappa, Kappa XLT, Vista or Vista XL	<b>MultiMed 6 pod patient cable</b> Use with: (Unimed Products) Such as: Temp: TSM-* (Page 245) SpO2: U708-23 (Page 170)		 TEMP./ECG/SPO <sub>2</sub>	D6.5
<b>DG-STE6</b>					
MS20093	Infinity Gamma, Gamma XL, Gamma X XL, Delta, Delta XL, Kappa, Kappa XLT, Vista or Vista XL	<b>MultiMed plus patient cable</b> Use with: (Unimed Products) Such as: Temp: TSM-* (Page 245) ECG 6-lead: DG6-90* Series (Page 25) SpO2: U710X-23 (Page 170)		 TEMP./ECG/SPO <sub>2</sub>	D6.5
<b>SM-MX5</b>					
5590539	Delta/Delta XL/Kappa/Gamma X XL/Vista XL/Kappa XLT	<b>NeoMed pod patient cable</b> Use with: (Unimed Products) Such as: Temp.:TSM-* (Page 245) ECG 5-lead: 2323* (Page 12) FIO <sub>2</sub> : N/A SpO2: U708-23 (Page 170)		 TEMP./TEMP./FIO <sub>2</sub> / ECG/SPO <sub>2</sub>	D6.5
<b>Accessories</b>					
Y05-T091	for unimed brand	The holder of the multi-parameter cable yoke to fix onto the pole or wall on bedside.			B5
Y05-T092	for original brand				B5.3



## Veterinary VitalSign Monitoring Cables & Accessories



### 1 SpO2 Sensor & Accessories

Sensor Type	Sensor REF#	Holder REF#		
Rectal/Reflect				
Figure.A	U800V Series	Figure: B REF: Y04-E050 Price: A3/1pc		
Lingual Clip				
Figure.C	U800 Multi-Site Series	Figure: D REF: UEC-01 Size: Smal Price: A6/1pc	Figure: E REF: UVC-02 Size: Medium Price: A7/1pc	Figure: F REF: UVC-01 Size: Large Price: A5/1pc

Contact Unimed sales representative for the REF# per the oximeter to be used.

### 2 ECG Adapter

#### Universal Vet ECG Adapter

Used with standard ECG leads with following electrodes  
Snap end; Grabber; 3mm needle or 4mm banana end electrode

Ref to fig.	REF#	Package	Price
Fig.G	UVC-05-10	10pcs/bag	D1
	UVC-05	1 pc/bag	A7
☆ Fig.H	UVC-06-10	10pcs/bag	C8.2





## 2 Cardiac Output Cable

Photo	REF#	Description	Compatibility	OEM REF#	Length	Price
	CO-HP-001	Philips Cardiac Output Cable	Philips M1012A, M1012A/C10, M3012A, 860338, 860335	Philips M1643A	4.8m	DD1.3
	CO-GE-001	GE Cardiac Output Cable	GE B450, B650, and B850 Monitors via the CARESCAPE Patient Data Module (PDM)	GE 2104180-002, 2104180-001, 2025248-001	3.6m	D3
	CO-SL-001	Spacelabs 6-pin Cardiac Output cable compatible with Baxter	Spacelabs 90496/91496 modules	Spacelabs 306655-003	3.0m	D6.6.5
	CO-SL-002	Spacelabs 10-pin Cardiac Output cable compatible with Baxter	Spacelabs 90496/91496 modules	Spacelabs 700-0027-00+ 306655-003	3.0m	D5.3
	CO-SL-003	Spacelabs 10-pin Cardiac Output cable compatible with Becton	Spacelabs 90496/91496 modules	Spacelabs 700-0027-00+ 306655-004	3.0m	D5.1.5

## PiCCO Cable

(Pulse-indicated Continuous Cardiac Output Cable)

### 1 PiCCO Cable

Photo	REF#	Description	Compatibility	OEM REF#	Length	Price
	CO-MR-002	PiCCO 12 Pin Cable (for injecta temperature and blood temperature)	Mindray BeneVision N Series/ BeneView T Series with PiCCO Module	Mindray CO7701, 040-000816-00	5.0m	D3
	BC-MR2-UT/2	PiCCO Y-Type IBP Cable (for artery pressure and central venous pressure)	Mindray BeneVision N Series/ BeneView T Series with PiCCO Module	Mindray IM2203, 040-000815-00	4.2m	C8.2

### 3 Others

Photo	REF#	Description	Compatibility	OEM REF#	Length	Price
	UNCC-009	Cardiac output remote start handswitch and cable	Philips M1012A, M3012A	Philips 15244A	0.9m	C5
	CO-SL-AD	TruLink Cardiac Output Adapter Cable	Spacelabs 90496/91496 modules	Spacelabs 700-0027-00	0.3m	C5





# Respiratory Consumables

- 1. Disposable Anesthesia & Ventilation Circuit** ..... 277
  - 1.1 Disposable Anesthesia Circuit ..... 278
  - 1.2 Disposable Ventilation Circuit ..... 279
  - 1.3 Disposable Anesthesia/Ventilation Circuit-set (Customized) ..... 279
  - 1.4 Disposable Catheter Mount ..... 279
- 2. Disposable Anesthesia & Ventilation Mask** ..... 280
  - 2.1 Disposable Anesthesia Mask ..... 281
  - 2.2 Oxygen Mask ..... 281
  - 2.3 CPR mask CPR ..... 281
- 3. Anesthesia & Ventilation Airway Management** ..... 282
  - 3.1 Disposable Laryngeal Mask ..... 283
  - 3.2 Endotracheal Tube ..... 283
  - 3.3 Fixer of Endotracheal Tube ..... 284
  - 3.4 Guedel Airway ..... 284
  - 3.5 Disposable Anesthesia Laryngoscope ..... 284
- 4. Disposable Anesthesia & Ventilation Accessories** ..... 285
  - 4.1 Heat and Moisture Exchanger and Filter(HMEF) ..... 285
  - 4.2 Breathing Bag ..... 286
  - 4.3 Water Trap ..... 286
  - 4.4 Enclosed Sputum Suction Tube ..... 286

### Certification



### Compliance with

EN ISO 13485:2012  
EN ISO 13485:2012/AC: 2012



# 1 Disposable Anesthesia & Ventilation Circuit

## Product Feature

- Made by non-toxic and smell-less material of medical level PP, PE, PVC
- Provide choices of corrugated, expandable and smooth bore circuits
- With excellent elasticity and flexibility, satisfy variety of demands
- Better pressure tightness to make sure fluent gas transfer
- Low weight and volume to support long distance shipping

## 1.1 Disposable Anesthesia Circuit

Image	Description	REF#	Length	Patient Size	Price (unit)	MOQ
	Expandable tubes, parallel wye W/gas sampling elbow	U-HK-03-S-A-001	1.0m	Adult	A3	900
		U-HK-03-S-A-002	1.2m	Adult	A3	900
		U-HK-03-S-A-003	1.5m	Adult	A3	900
		U-HK-03-S-A-004	1.8m	Adult	A3	900
		U-HK-03-S-P-001	1.0m	Pediatric	A3	900
		U-HK-03-S-P-002	1.2m	Pediatric	A3	900
		U-HK-03-S-P-003	1.5m	Pediatric	A3	900
		U-HK-03-S-P-004	1.8m	Pediatric	A3	900
	Corrugated tubes, parallel wye W/gas sampling elbow	U-HK-03-C-A-001	1.0m	Adult	A4	1000
		U-HK-03-C-A-002	1.2m	Adult	A4	1000
		U-HK-03-C-A-003	1.5m	Adult	A5	1000
		U-HK-03-C-A-004	1.8m	Adult	A5.5	1000
		U-HK-03-C-P-001	1.0m	Pediatric	A3	1000
		U-HK-03-C-P-002	1.2m	Pediatric	A4	1000
		U-HK-03-C-P-003	1.5m	Pediatric	A4	1000
		U-HK-03-C-P-004	1.8m	Pediatric	A4	1000
		U-HK-03-C-I-001	1.0m	Infant	A3	1000
		U-HK-03-C-I-002	1.2m	Infant	A4	1000
		U-HK-03-C-I-003	1.5m	Infant	A4	1000
		U-HK-03-C-I-004	1.8m	Infant	A4	1000
	Smooth bore tubes, parallel wye W/gas sampling elbow	U-HK-04-Q-A-101	1.5m	Adult	A8	1000
		U-HK-04-Q-A-102	1.8m	Adult	B1	1000
		U-HK-04-Q-P-101	1.5m	Pediatric	A8	1000
		U-HK-04-Q-P-102	1.8m	Pediatric	B1	1000
	Duo Limbo	U-HK-03-ZF-A-001	1.5m	Adult	A7	1000
		U-HK-03-ZF-A-002	1.8m	Adult	A8	1000
		U-HK-03-ZF-A-003	2.4m	Adult	B1	1000
	Coaxial	U-HK-03-T-A-001	1.5m	Adult	A6	1000
		U-HK-03-T-A-002	1.8m	Adult	A7	1000
		U-HK-03-T-A-003	2.1m	Adult	A7	1000
		U-HK-03-T-A-004	2.4m	Adult	A7	1000



## 1.2 Disposable Ventilation Circuit

Image&Description	REF#	Length	Patient Size	Water Trap Info.	Price (unit)	MOQ
 <p>Corrugated tubes, parallel wye W/gas sampling elbow</p>	U-HK-04-C-A-011	1.8m	Adult	Y connector(2 holes), 2 water traps	A8	1000
	U-HK-04-C-A-012	1.8m	Adult	Y connector(w/o holes), 2 water traps	A8	1000
	U-HK-04-C-A-013	1.8m	Adult	Y connector(2 holes), 1 water trap	A7	1000
	U-HK-04-C-A-014	1.8m	Adult	Y connector(w/o holes),1 water trap	A7	1000
	U-HK-04-C-P-011	1.8m	Pediatric	Y connector(2 holes), 2 water traps	A7	1000
	U-HK-04-C-P-012	1.8m	Pediatric	Y connector(w/o holes), 2 water traps	A7	1000
	U-HK-04-C-P-013	1.8m	Pediatric	Y connector(2 holes),1 water trap	A7	1000
	U-HK-04-C-P-014	1.8m	Pediatric	Y connector(w/o holes), 1 water trap	A7	1000
 <p>Smooth bore tubes, parallel wye W/gas sampling elbow</p>	U-HK-04-Q-A-001	1.8m	Adult	Y connector(2 holes), 2 water traps	B4	900
	U-HK-04-Q-A-002	1.8m	Adult	Y connector(w/o holes), 2 water traps	B4	900
	U-HK-04-Q-A-003	1.8m	Adult	Y connector(2 holes), 1 water trap	B3	900
	U-HK-04-Q-A-004	1.8m	Adult	Y connector(w/o holes), 1 water trap	B3	900
	U-HK-04-Q-P-001	1.8m	Pediatric	Y connector(2 holes), 2 water traps	B4	900
	U-HK-04-Q-P-002	1.8m	Pediatric	Y connector(w/o holes), 2 water traps	B4	900
	U-HK-04-Q-P-003	1.8m	Pediatric	Y connector(2 holes), 1 water trap	B3	900
	U-HK-04-Q-P-004	1.8m	Pediatric	Y connector(w/o holes), 1 water trap	B3	900



## 1.3 Disposable Anesthesia/Ventilation Circuit-set (Customized)

Description	REF#	Length	Patient Size	Price (unit)	MOQ
 <p>Expandable tubes, with mask, breathing bag, HMEF</p>	U-HK-03-S-A-101	1.5m	Adult	A8	1000
	U-HK-03-S-P-102	1.5m	Pediatric	A8	1000

## 1.4 Disposable Catheter Mount

Description	REF#	Length	Texture	Price (unit)	MOQ	REF to Figures
 <p>Disposable Catheter Mount</p>	U-HK-03-SP-003	20cm	Expandable Tube	A2	1000	1
	U-HK-03-SP-001	20cm	Corrugated Tube	A2	1000	2
	U-HK-03-SP-002	20cm	Smooth Bore Tube	A3	1000	3



## 2 Disposable Anesthesia & Ventilation Mask

### Product Feature

- Made by non-toxic and smell-less material of medical level PC, PVC,PP
- Soft Air-cushion design to provide a more comfortable user experience
- Unique shell design allows a tougher grip of the mask
- High precision of valve design to prevent gas leaking

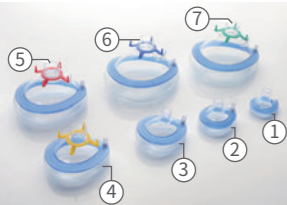

## 2.1 Disposable Anesthesia Mask

Image&Description	REF#	Connector Size	Patient Size	Size No.	Price (unit)	MOQ	REF to Images
 <p>Gas valve up</p>	U-HK-05-A-0	10mm connector	Infant	#0	A3	1000	1
	U-HK-05-A-1	15mm connector	Pediatric	#1	A3	1000	2
	U-HK-05-A-2	15mm connector	Pediatric	#2	A3	1000	3
	U-HK-05-A-3	22mm connector	Adult	#3	A3	1000	4
	U-HK-05-A-4	22mm connector	Adult	#4	A3	1000	5
	U-HK-05-A-5	22mm connector	Adult	#5	A3	1000	6
 <p>Gas valve horizontal</p>	U-HK-05-B-1	15mm connector	Pediatric	#1	A3	1000	1
	U-HK-05-B-2	15mm connector	Pediatric	#2	A3	1000	2
	U-HK-05-B-3	22mm connector	Adult	#3	A3	1000	3
	U-HK-05-B-4	22mm connector	Adult	#4	A3	1000	4
	U-HK-05-B-5	22mm connector	Adult	#5	A3	1000	5
	U-HK-05-B-6	22mm connector	Adult	#6	A3	1000	6

## 2.2 Oxygen Mask

Image	REF#	with Part	Patient Size	Price (unit)	MOQ
	U-HK-05-YH-1	with Nebulizer	Pediatric Standard	A3	1000
	U-HK-05-YH-2	with Nebulizer	Pediatric Elongated	A3	1000
	U-HK-05-YH-3	with Nebulizer	Adult Standard	A3	1000

## 2.3 CPR mask

Image	REF#	with Part	Patient Size	Price(unit)	MOQ
	U-HK-05-ER-1	with PC Case	Adult	A5.5	1000



# 3 Anesthesia & Ventilation Airway Management





### Product Feature

- Made by non-toxic and smell-less material of medical level PC, PE etc.
- Highly smooth and stable gas transmission
- Soft exterior design makes no harm to human skin
- LED cold light source provides a bright and clear vision

### 3.1 Disposable Laryngeal Mask

Image	REF#	Inner Diameter Size	Soft Steel Info.	Price(unit)	MOQ
	U-HK-10-1.0	ID 1.0mm	w/o Soft Steel	A8	1000
	U-HK-10-1.5	ID 1.5mm			
	U-HK-10-2.0	ID 2.0mm			
	U-HK-10-2.5	ID 2.5mm			
	U-HK-10-3.0	ID 3.0mm			
	U-HK-10-3.5	ID 3.5mm			
	U-HK-10-4.0	ID 4.0mm	w/ Soft Steel	B6.6	1000
	UR-HK-10-1.0	ID 1.0mm			
	UR-HK-10-1.5	ID 1.5mm			
	UR-HK-10-2.0	ID 2.0mm			
	UR-HK-10-3.0	ID 3.0mm			
	UR-HK-10-4.0	ID 4.0mm			
	UR-HK-10-5.0	ID 5.0mm			

### 3.2 Endotracheal Tube

Image	REF#	Inner Diameter Size	Balloon Info.	Soft Steel Info.	Price (unit)	MOQ
	U-HK-14-2	ID 2mm	w/ Balloon	w/o Soft Steel	A2	1000
	U-HK-14-3	ID 3mm				
	U-HK-14-4	ID 4mm				
	U-HK-14-5	ID 5mm				
	U-HK-14-6	ID 6mm				
	U-HK-14-7	ID 7mm				
	U-HK-14-8	ID 8mm				
	U-HK-14-9	ID 9mm				
	U-HK-14-10	ID 10mm				
		UN-HK-14-2				
UN-HK-14-3		ID 3mm				
UN-HK-14-4		ID 4mm				
UN-HK-14-5		ID 5mm				
UN-HK-14-6		ID 6mm				
UN-HK-14-7		ID 7mm				
UN-HK-14-8		ID 8mm				
UN-HK-14-9		ID 9mm				
UN-HK-14-10		ID 10mm				
		U-HK-15-2	ID 2mm	w/ Balloon	w/ Soft Steel	A5
	U-HK-15-3	ID 3mm				
	U-HK-15-4	ID 4mm				
	U-HK-15-5	ID 5mm				
	U-HK-15-6	ID 6mm				
	U-HK-15-7	ID 7mm				
	U-HK-15-8	ID 8mm				
	U-HK-15-9	ID 9mm				
	U-HK-15-10	ID 10mm				
		UN-HK-15-2	ID 2mm			
UN-HK-15-3		ID 3mm				
UN-HK-15-4		ID 4mm				
UN-HK-15-5		ID 5mm				
UN-HK-15-6		ID 6mm				
UN-HK-15-7		ID 7mm				
UN-HK-15-8		ID 8mm				
UN-HK-15-9		ID 9mm				
UN-HK-15-10		ID 10mm				

### 3.3 Fixer of Endotracheal Tube

Image	REF#	Size No.	Price (unit)	MOQ
	U-HK-14-40-S	40mm	A3	100

### 3.4 Guedel Airway

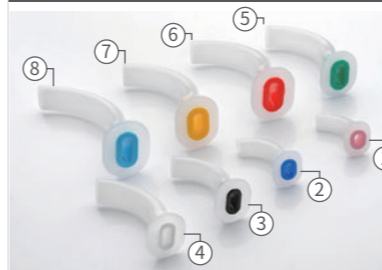
Image	REF#	Size No.	Number#	Price (unit)	MOQ	REF to Images
	U-HK-11-A-4	40mm	#4	A1	2000	1
	U-HK-11-A-5	50mm	#5	A1	2000	2
	U-HK-11-A-6	60mm	#6	A1	2000	3
	U-HK-11-A-7	70mm	#7	A1	2000	4
	U-HK-11-A-8	80mm	#8	A1	2000	5
	U-HK-11-A-9	90mm	#9	A1	2000	6
	U-HK-11-A-10	100mm	#10	A1	2000	7
	U-HK-11-A-11	110mm	#11	A1	2000	8
	U-HK-11-A-12	120mm	#12	A1	2000	/

### 3.5 Disposable Anesthesia Laryngoscope

Images	Type	REF#	Pattern	Patient Size	Price	MOQ	REF to Images
	Full Set	U-01-MHJ05	LED	General Use	B6.6	100	/
		U-01-MHJJT	Optical-fibre	General Use	B6.6	100	/
	Handle	U-01-MHB05	LED	General Use	A2	1000	8
		U-01-MHGJT	Optical-fibre	General Use	A5	1000	8
	Blade	U-01-MHJ05-95	Curved 95mm	Infant	A3	1000	1
		U-01-MHJ05-120	Curved 120mm	Pediatric	A3	1000	2
		U-01-MHJ05-140	Curved 140mm	Adult	A3	1000	3
		U-01-MHJ05-160	Curved 160mm	Adult	A4	1000	4
		U-01-MHJ05-75	Straight 75mm	Infant	A3	1000	5
		U-01-MHJ05-100	Straight 100mm	Pediatric	A3	1000	6
		U-01-MHJ05-130	Straight 130mm	Adult	A3	1000	7

## 4 Disposable Anesthesia & Ventilation Accessories



### 4.1 Heat and Moisture Exchanger and Filter (HMEF)

Image	REF#	Angled/Straight Connector	Minimum Tidal Volume	Dead Space	Weight	Price	MOQ
	U-HK-06-F-01	Straight Connector	75 ml	29 ml	24.5 g	A2	1000

### 4.2 Breathing Bag

Image	REF#	Material	Capacity	Price (unit)	MOQ	REF to Images
	U-HK-04-SP-001	Latex	0.5L	A3	1000	/
	U-HK-04-SP-002	Latex	1L	A3	1000	1
	U-HK-04-SP-003	Latex	2L	A4	1000	2
	U-HK-04-SP-004	Latex	3L	A4	1000	3
	U-HK-04-SP-005	latex-free	0.5L	A4	1000	4
	U-HK-04-SP-006	latex-free	1L	A4	1000	/
	U-HK-04-SP-007	latex-free	2L	A4	1000	5
	U-HK-04-SP-008	latex-free	3L	A4	900	6

### 4.3 Water Trap

Image	REF#	Patient Size	O-ring	Price (unit)	MOQ
	U-HK-04-SP-013	Adult	with O-ring	A2	1000
	U-HK-04-SP-014	Pediatric	with O-ring	A2	1000

### 4.4 Enclosed Sputum Suction Tube

Image	REF#	Size	Outer Diameter	Length	Patient Size	Price (unit)	MOQ
	U-HK-08-6-Fr	6fr	OD 2mm	450mm	Pediatric	A7	1000
	U-HK-08-8-Fr	8fr	OD 2.6mm	450mm	Pediatric	A7	1000
	U-HK-08-10-Fr	10fr	OD 3.3mm	600mm	Adult	A8	1000
	U-HK-08-12-Fr	12fr	OD 4mm	600mm	Adult	A8	1000
	U-HK-08-14-Fr	14fr	OD 4.7mm	600mm	Adult	B1	1000
	U-HK-08-16-Fr	16fr	OD 5.3mm	600mm	Adult	B1	1000